

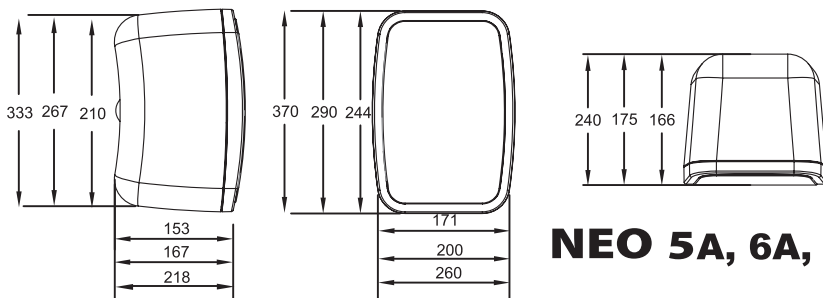

NEO Active/Activas



User Manual / Manual de Uso



NEO 5A, 6A, 8A (bigger)

A NEO 5A/6A contains two loudspeakers (black or white) one active+one passive, and two wall-mount brackets.

NEO 8A is sell only as individual item (active)

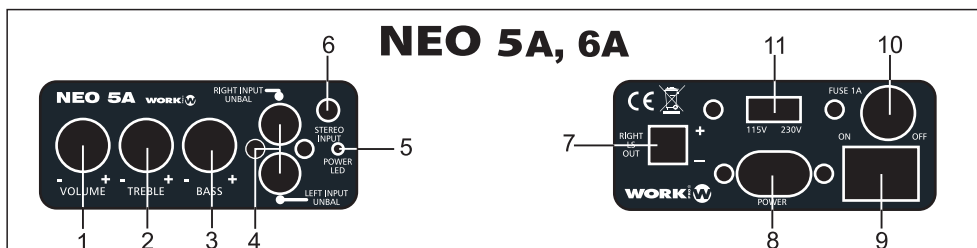

NEO 5A, 6A

1	Volume Control
2	Treble Control
3	Bass Control
4	L/R Unbalanced Input (RCA connectors)
5	LED power
6	Stereo input (Mini-jack 3.5 mm) (*)

7	Link connection 2-pin euroblock (Passive unit)
8	Mains supply input (Use the included cable)
9	Power Switch ON/OFF
10	Fuse Holder
11	AC 115V/230V main power selector

NEO 8A

1	Volume Control
2	Treble Control
3	Bass Control
4	L/R Unbalanced Input (RCA connectors)
5	LED power
6	Euroblock input (balanced)

7	Mains supply input (Use the included cable)
8	Power Switch ON/OFF
9	Fuse Holder
10	AC 115V/230V main power selector

Elements.....	5" Woofer + 0,5" Tweeter
Power Output	2 x 25 W RMS
Input Sensitivity.....	1V /2.21 dBu
Frequency Response	94 Hz - 20 kHz
Dimensions	171 x 244 x 166 mm
Material (enclosure)	ABS plastic
IP rating	IP 54
RAL colour code	RAL 9003 (W) / RAL 9004 (B)
Material (grille)	Aluminium
Weight	4.4 kg

Specifications are subject to change without notice

Elements.....	6.5" Woofer + 1" Tweeter
Power Output	2 x 30 W RMS
Input Sensitivity.....	1V /2.21 dBu
Frequency Response	80Hz - 20kHz
Dimensions	200 x 290 x 175 mm
Material (enclosure)	ABS plastic
IP rating	IP 54
RAL colour code	RAL 9003 (W) / RAL 9004 (B)
Material (grille)	Aluminium
Weight	5,1 kg

Specifications are subject to change without notice

Elements.....	8" Woofer + 1" Tweeter
Power Output	40 W RMS
Input Sensitivity.....	1V /2.21 dBu
Frequency Response	50Hz - 20kHz
Dimensions	260 x 370 x 240 mm
Material (enclosure)	ABS plastic
IP rating	IP 54
RAL colour code	RAL 9003 (W) / RAL 9004 (B)
Material (grille)	Aluminium
Weight	5,46 Kg

Specifications are subject to change without notice

IP54 weather proof rating

The NEO Active/Activas is rated to IP54 which means there is limited dust and water ingress protection.

The NEO Active/Activas is designed for both indoor and outdoor operation where it is protected from direct exposure to water (e.g. under a canopy). The use of protection from water and humidity for the connection terminals is highly recommended (e.g. sealant/mastic).

Plastic Wall-mount bracket (NEO 5A, NEO 6A, NEO 8A)

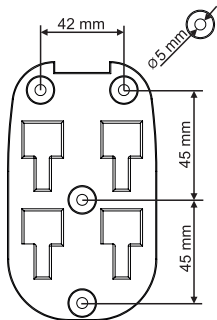
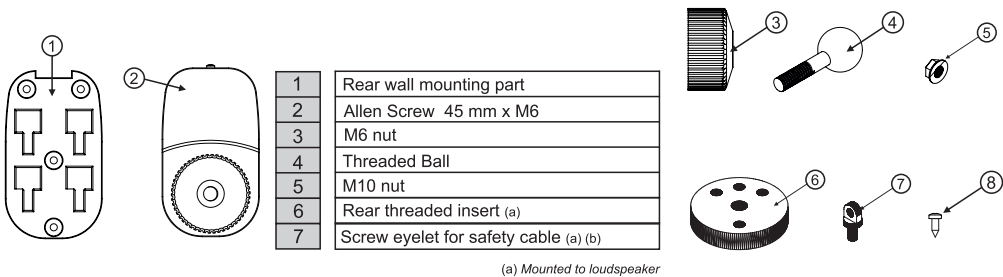

figure 1

Mounting Process

Use the wall mounting part (1) to mark the fixing points on the wall. Take into account the dimensions between holes and the diameters marked in figure 1. Drill wall and insert wall fixings. Screw wall mounting part to wall. Ensure that suitable screws and wall fixings are used. If in any doubt contact a suitably qualified expert.

Mount (3), (4) & (5) as shown in figure 2. Screw the threaded ball (4) into the threaded insert on the rear of the loudspeaker (6) (loudspeaker not shown below). Tighten M10 nut (5) against the loudspeaker with a spanner. The assembly will now be as shown in figure 3.

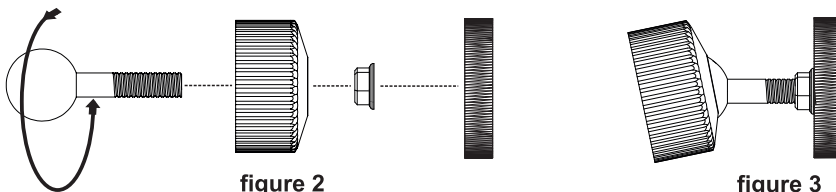

figure 2

figure 3

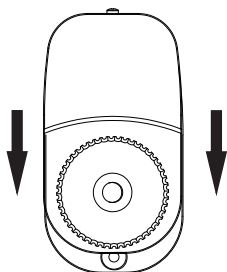
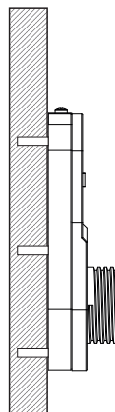
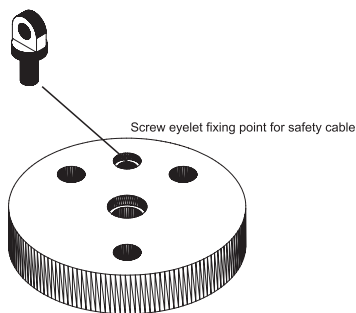
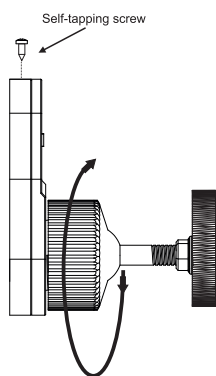

figure 4

Slide the hooks of the front threaded part (2) down in to the slots of the wall mount part (1). (figure 4)



Screw on the rotary knurled ring (3) several turns (do not tighten completely). Now adjust the loudspeaker to the desired position. Hold the speaker in position and tighten the knurled ring (3) completely. Use the self tapping screw (7) provided in order to lock parts (1) & (2) together.



WARNING: The maximum loading of this bracket (8 kg), must never be exceeded. No other items must be suspended or attached to the bracket or speaker enclosure.



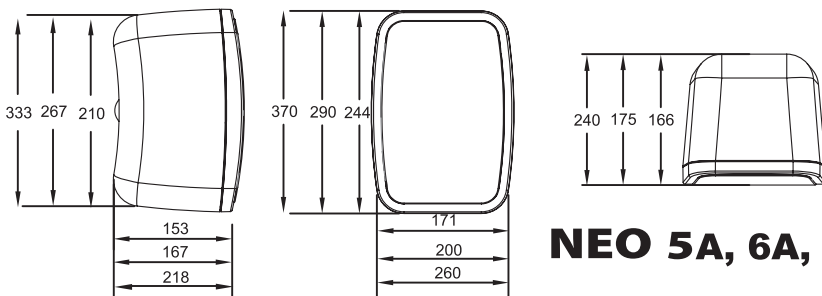

NEO 5A, 6A, 8A (bigger)

NEO 5A/6A contiene dos altavoces (blancos o negros). Uno activo+ otro pasivo y dos soportes de pared.

NEO 8A se vende como producto individual (activo)

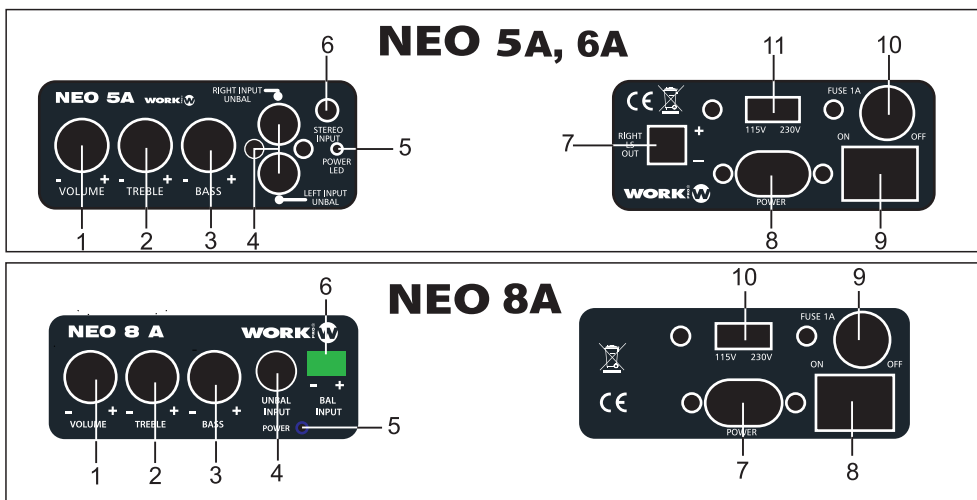

NEO 5A, 6A

1	Control Volume
2	Control Treble
3	Control Bass
4	Entrada L/R desbal. (conect. RCA)
5	LED power
6	Entrada estéreo (Mini-jack 3.5 mm) (*)
7	Conex. Link 2-pin euroblock (Unidad pasiva)
8	Mains supply input (Use the included cable)
9	Interruptor ON/OFF
10	Fusible
11	Selector de voltaje AC 115V/230V

NEO 8A

1	Control Volume
2	Control Treble
3	Control Bass
4	Entrada L/R desbal. (conect. RCA)
5	LED power
6	Entrada Euroblock (balanceada)
7	Mains supply input (Use el cable incluido)
8	Interruptor ON/OFF
9	Fusible
10	Selector de voltaje AC 115V/230V

Elementos.....	5" Woofer + 0,5" Tweeter
Potencia de Salida	2 x 25 W RMS
Sensibilidad de entrada.....	1V /2.21 dBu
Respuesta en frecuencia	94 Hz - 20 kHz
Dimensiones	171 x 244 x 166 mm
Material (recinto)	Plástico ABS
Rango IP	IP 54
Código color RAL	RAL 9003 (W) / RAL 9004 (B)
Material (rejilla)	Aluminio
Peso	4.4 kg

Las especificaciones están sujetas a cambio sin previo aviso.

Elementos.....	6.5" Woofer + 1" Tweeter
Potencia de Salida	2 x 30 W RMS
Sensibilidad de entrada.....	1V /2.21 dBu
Respuesta en frecuencia.....	80Hz - 20kHz
Dimensiones	200 x 290 x 175 mm
Material (recinto)	Plástico ABS
Rango IP	IP 54
Código color RAL	RAL 9003 (W) / RAL 9004 (B)
Material (rejilla)	Aluminio
Peso	5,1 kg

Las especificaciones están sujetas a cambio sin previo aviso.

Elementos.....	8" Woofer + 1" Tweeter
Potencia de Salida	40 W RMS
Sensibilidad de entrada.....	1V /2.21 dBu
Respuesta en frecuencia.....	50Hz - 20kHz
Dimensiones	260 x 370 x 240 mm
Material (recinto)	Plástico ABS
Rango IP	IP 54
Código color RAL	RAL 9003 (W) / RAL 9004 (B)
Material (rejilla)	Aluminio
Peso	5,46 Kg

Las especificaciones están sujetas a cambio sin previo aviso.

Rango de protección IP54

La serie NEO dispone de un rango de protección IP 54 el cual significa que tiene una protección limitada al ingreso de agua y polvo.

La serie NEO está diseñada tanto para instalaciones en interior como exterior donde está protegida de la exposición directa al agua (debajo de un dosel). Es muy recomendable el uso de protecciones contra el agua o la humedad en los terminales de conexión (p.e. sellándolos con silicona o masilla).

Soporte de montaje en plástico (NEO 5A, NEO 6A, NEO 8A)

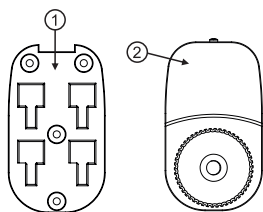

1	Pieza de montaje trasera pared
2	Tornillo Allen 45 mm x M6
3	Tuerca M6
4	Bola roscada
5	Tuerca M10
6	Pieza de inserción trasera (a)
7	Tornillo fijación cable de seguridad (a) (b)

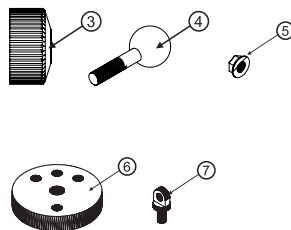

(a) Montado en el altavoz



figura 1

Proceso de Montaje

Use la pieza de montaje (1) para marcar los puntos de fijación a la pared. Tenga en cuenta las medidas y diámetros marcados en la figura 1.

Fije la pieza a la pared. Asegúrese de fijarlo con todos los tornillos. Si tiene cualquier duda, consulte con un técnico.

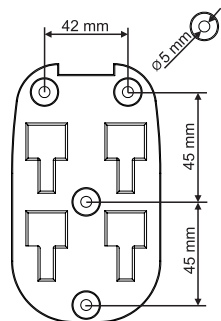
Monte las piezas (3), (4) y (5) como muestra la figura 2. Atornille la pieza (4) dentro de la inserción roscada del altavoz (6). Fije la tuerca M10 (5) contra el altavoz. El montaje se muestra en la figura 3 3.



figura 2



figura 3

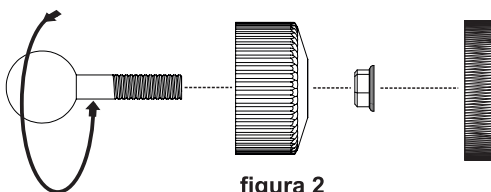

figura 4

Deslice la pieza frontal sobre la pieza montada en la pared (figura 4)

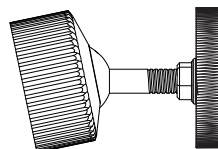

Atornille el aro rotativo (3) varias veces (sin fijarlo totalmente).
 Ahora ajuste el altavoz en la posición deseada.
 Fije el altavoz y apriete el aro (3) completamente.
 Use el tornillo de fijación del cable (7).

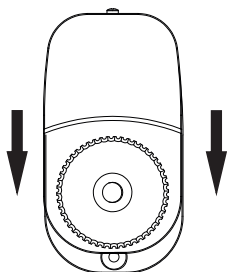
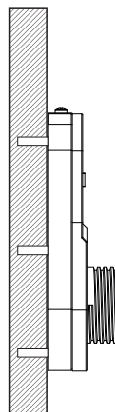
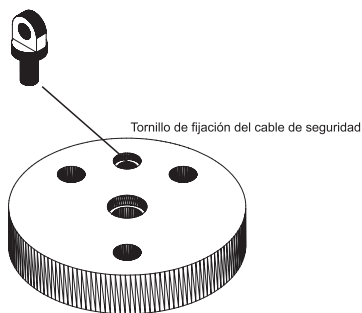
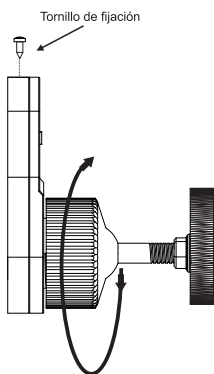

ATENCIÓN: La carga máxima soportada por ester soporte (8 kg), no debe sobrepasarse.
 No se debe utilizar para la fijación de un elemento distinto de estos modelos de altavoz.





This symbol on the product or on its packaging indicates that this product shall not be treated as household waste. Instead it shall be handed over to the applicable collection point for the recycling of electrical and electronic equipment. By ensuring this product is disposed of correctly, you will help prevent potential negative consequences for the environment and human health, which could otherwise be caused by inappropriate waste handling of this product. The recycling of materials will help to conserve natural resources. For more detailed information about recycling of this product, please contact your local city office, your household waste disposal service or the shop where you purchased the product.

Manufactured by **EQUIPSON, S.A.**

<http://www.equipson.es>