

# EVOX J8

## ACTIVE TWO WAY PORTABLE ARRAY

### DESCRIPTION

The RCF J8 features a line source satellite module with eight 2" full-range drivers paired with a high-powered 12" woofer in a bass reflex enclosure. All powered by on-board 1400 W Class D amplification. The EVOX J Series maintains a similar footprint to the original EVOX systems, now in a portable composite enclosure. The system offers stunning sound performance with crystal-clear vocal reproduction and unparalleled musical response.



### FEATURES

- 128 dB Max SPL
- 1400 Watt 2-way power
- DSP Processing with FiRPHASE
- 12" woofer, high power 2.5" voice coil
- 8 x 2" ultra compact fullrange 1.0" voice coil
- 2350x350x450 mm 92.5x13.77x17.71 in (HxWxD)
- 23,8/52.5 kg/lbs

## TECHNICAL SPECIFICATIONS

<b>Acoustical specifications</b>	Frequency Response:	40 Hz ÷ 20000 Hz
	Max SPL @ 1m:	128 dB
	Horizontal coverage angle:	120°
	Vertical coverage angle:	30°
<b>Transducers</b>	Fullrange:	8 x 2.0", 1.0" v.c
	Woofers:	12", 2.5" v.c
<b>Input/Output section</b>	Input signal:	bal/unbal
	Input connectors:	XLR, Jack
	Output connectors:	XLR
	Input sensitivity:	-2 dBu/+4 dBu
<b>Processor section</b>	Crossover Frequencies:	220 Hz
	Protections:	Thermal, RMS
	Limiter:	Soft Limiter
	Controls:	Volume, Boost, Mic/Line
<b>Power section</b>	Total Power:	1400 W Peak, 700 W RMS
	High frequencies:	400 W Peak, 200 W RMS
	Low frequencies:	1000 W Peak, 500 W RMS
	Cooling:	Convection
	Connections:	VDE
<b>Standard compliance</b>	CE marking:	Yes
<b>Physical specifications</b>	Cabinet/Case Material:	PP Composite
	Handles:	1 Top
	Grille:	Steel
	Color:	Black, White
<b>Size</b>	Height:	2285 mm / 89.96 inches
	Width:	400 mm / 15.75 inches
	Depth:	460 mm / 18.11 inches
	Weight:	20.2 kg / 44.53 lbs
<b>Shipping informations</b>	Package Height:	676 mm / 26.61 inches
	Package Width:	451 mm / 17.76 inches
	Package Depth:	581 mm / 22.87 inches
	Package Weight:	29.9 kg / 65.92 lbs



**PART NUMBER**

- **13000568**

EVOX J8 W  
115V, White  
EAN 8024530015596

- **13000567**

EVOX J8 W  
220-240V, White  
EAN 8024530015589

- **13000555**

EVOX J8  
115V, Black  
EAN 8024530015558

- **13000554**

EVOX J8  
220-240V, Black  
EAN 8024530015541

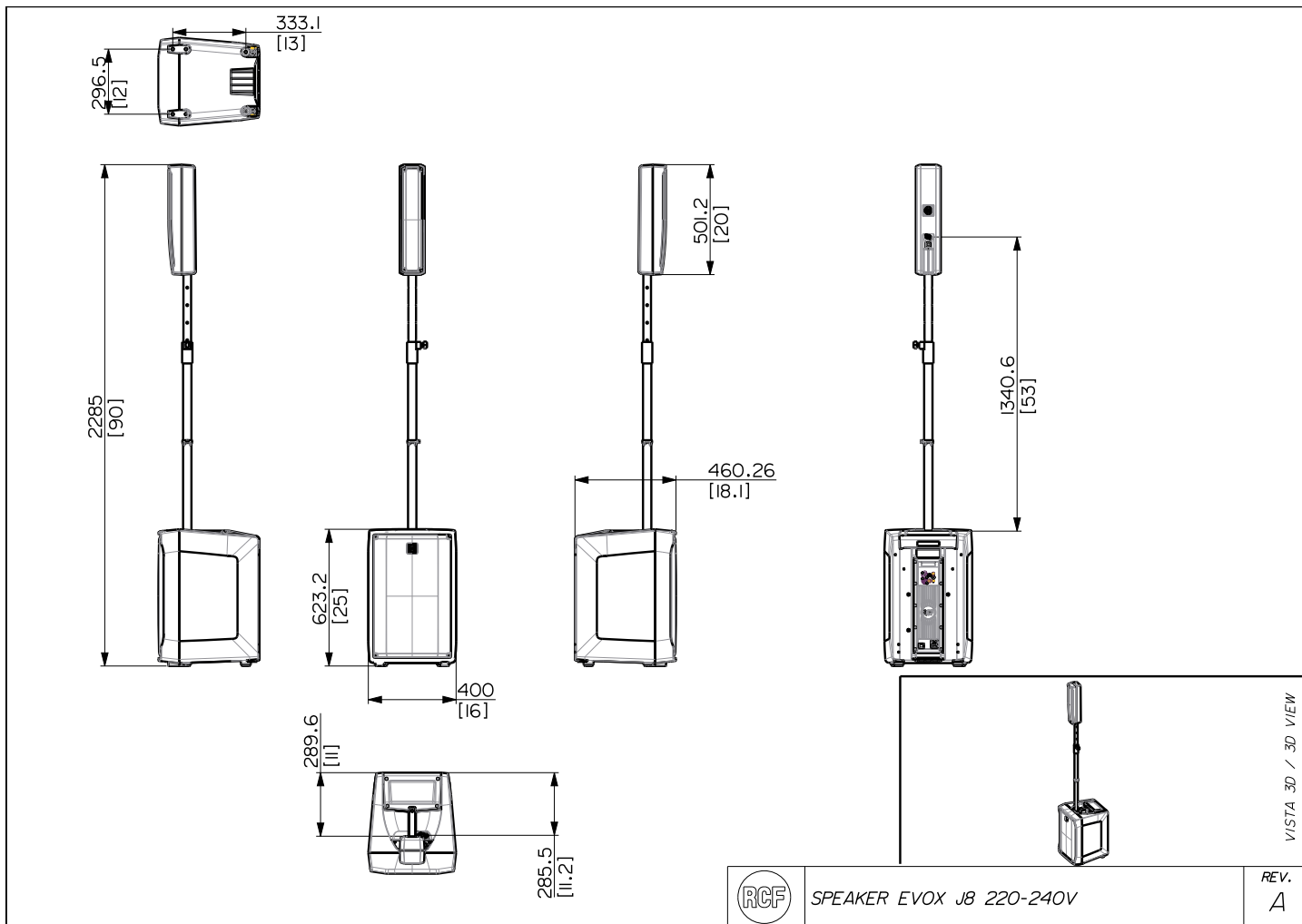

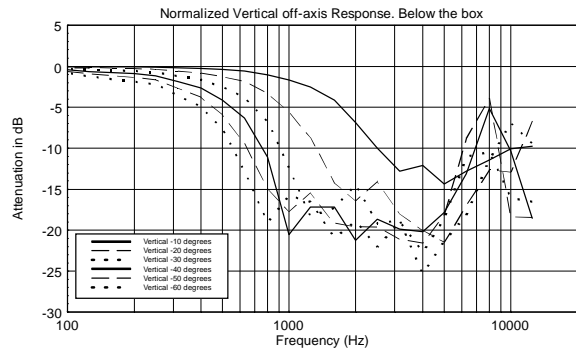
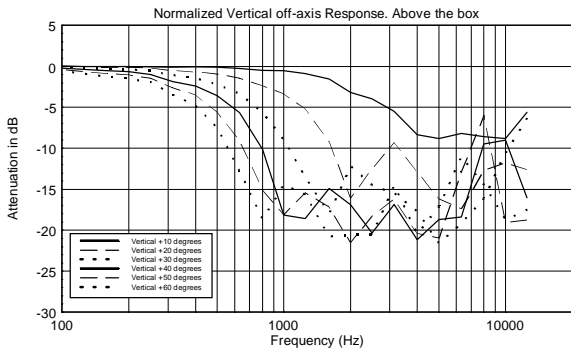
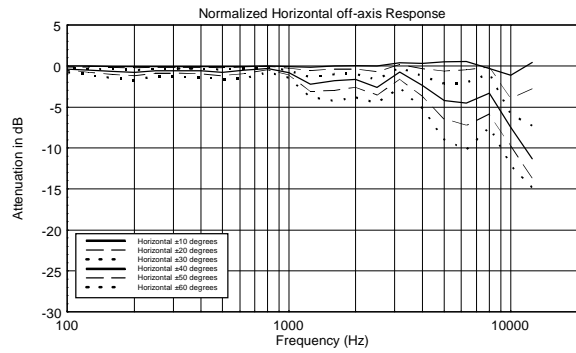
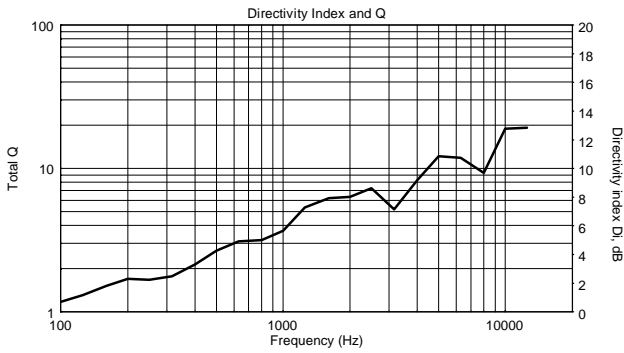
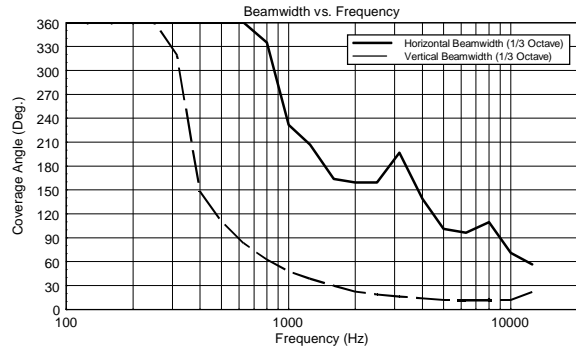
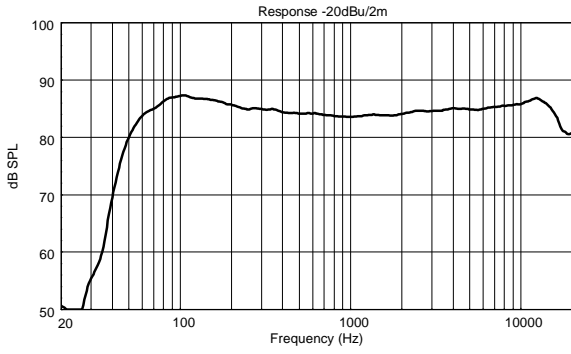

Horizontal 1/3 Octave Polars

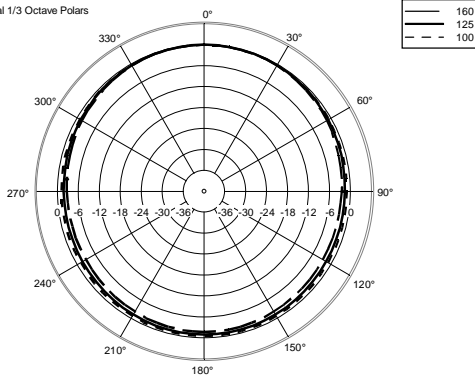

Horizontal 1/3 Octave Polars

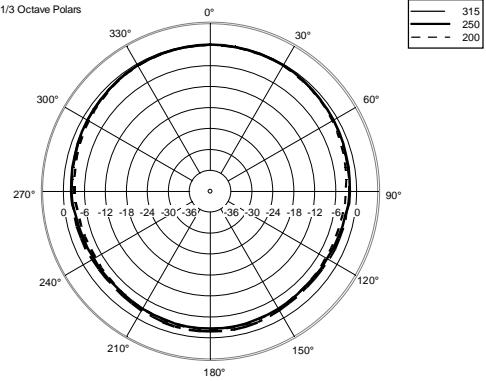

Horizontal 1/3 Octave Polars

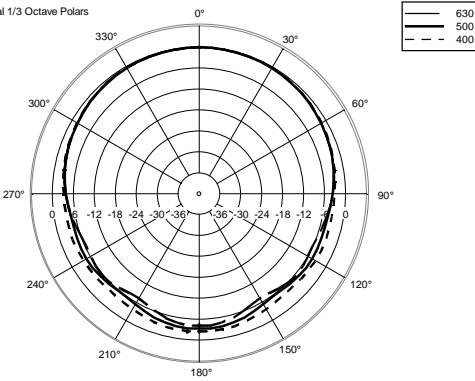

Horizontal 1/3 Octave Polars

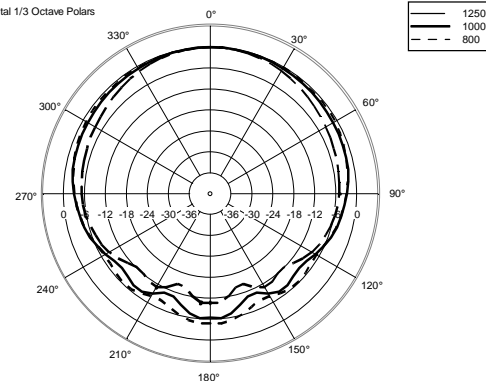

Horizontal 1/3 Octave Polars

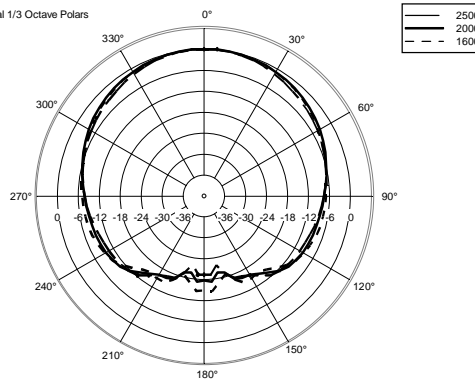

Horizontal 1/3 Octave Polars

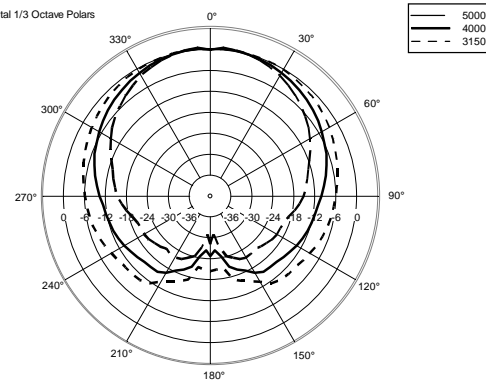

Horizontal 1/3 Octave Polars

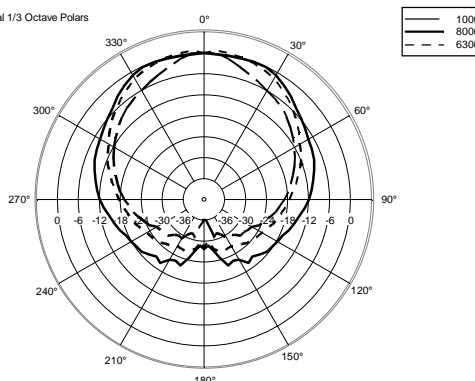

Horizontal One Octave Polars

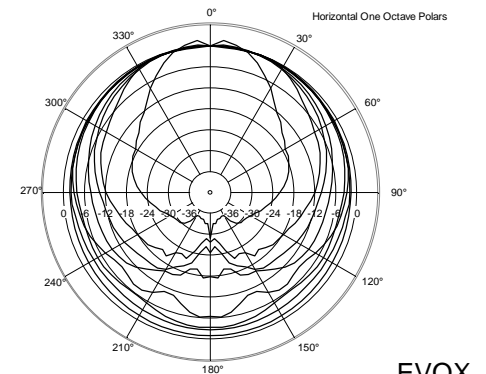

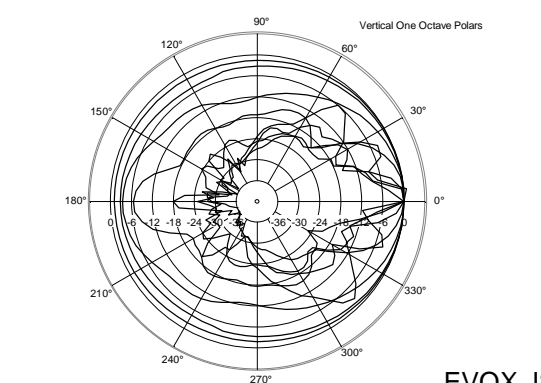
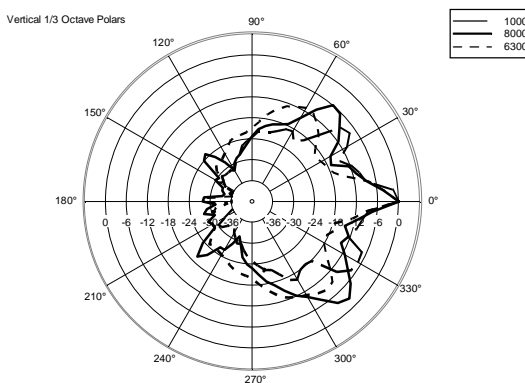
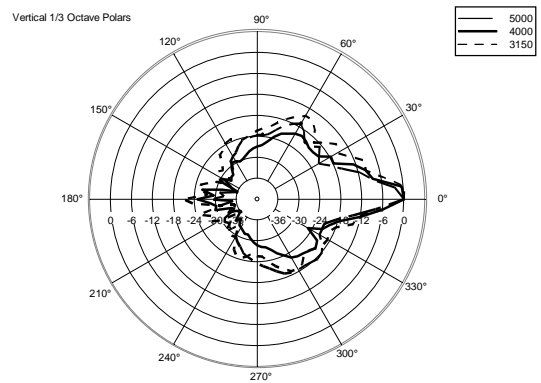
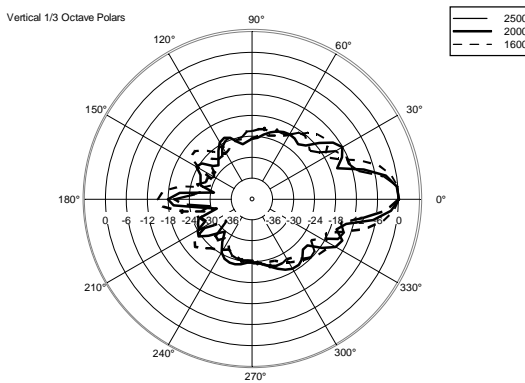
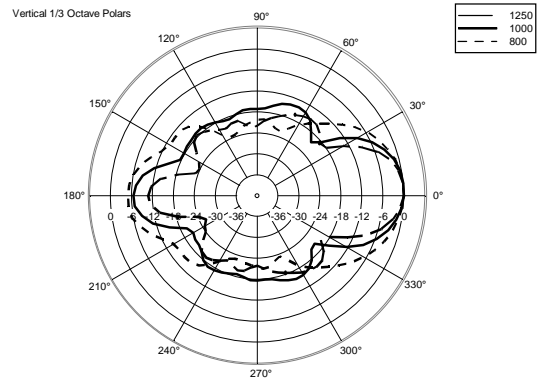
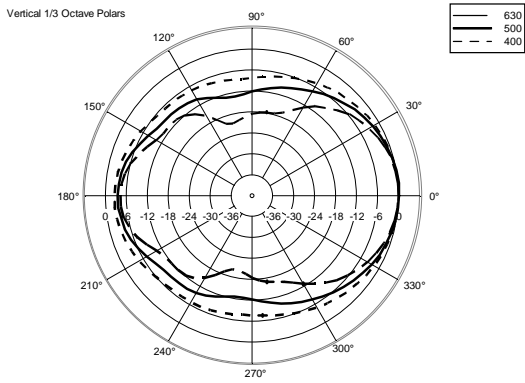
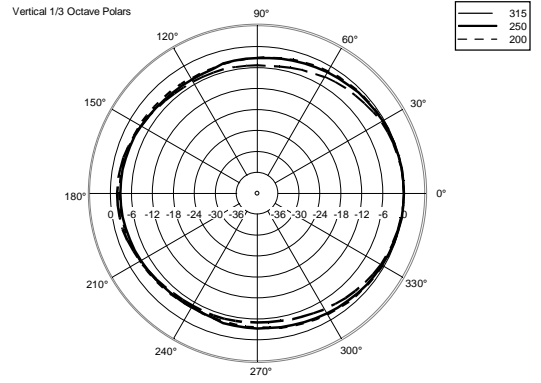
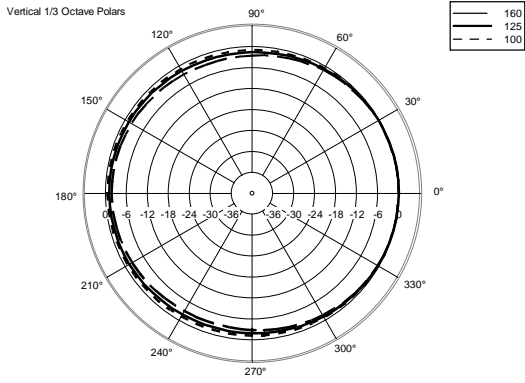

**ACCESSORIES**

COVER CVR EVOX J

PART NUMBER **13360407**

EAN: 8024530015725



COVER CVR-WH EVOX J

PART NUMBER **13360406**

EAN: 8024530015718



DETACHABLE TROLLEY EVOX

PART NUMBER **13360306**

EAN: 8024530012366