

# USB HD PTZ Camera

---

User Manual V1.0

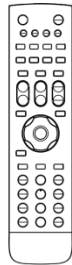

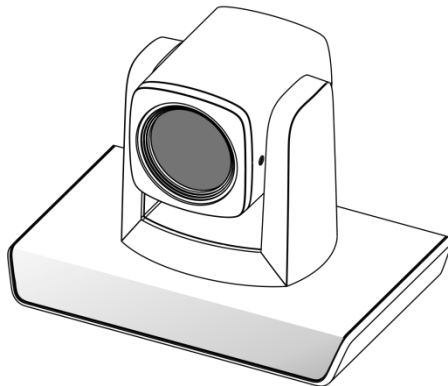

---

## SAFETY NOTES

- Before installing the device, please read this manual carefully and follow instructions indicated to ensure proper operation. Please keep this manual for future reference.
- Before powering on the device, please check the input power voltage carefully, the camera accepts DC5V, otherwise, it may cause damage to the camera.
- Please put USB data cable, video and control cables at safe place in order not to cause malfunction to the device.
- Please put the device into use at required working temperature and humidity, working condition of the device is 0°C~+40°C , humidity at < 90 % . Please avoid to have unrelated objects get into the device like corrosive liquid that may cause damage / danger.
- Please avoid shock, vibration, soaking may cause to the device when transporting and installing, otherwise, it may cause damage to the camera.
- Please only refer to authorized personnel to repair the device, do not disassemble the camera by yourself.
- Only use USB data cable and control cables, and the cables should be connected separately in order to ensure proper use. Do not aim the camera lens at sunlight or strong lights that may cause damage to the imaging system of the device.
- Please use soft cloth to clean the device, do not use strong or abrasive detergent to clean that will damage the device's housing / lens.

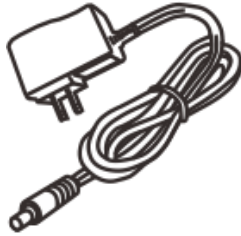

1

## Warnings

1. If you need to extend the power cable, please extend the power cable from the part on below picture (220V/110V), do not extend from part 1 on below picture (DC12V), otherwise it will cause unexpected damage to the device.
2. To prevent infringement of the rights of others, please confirm that it is installed and used within the scope permitted by local law!

---

# CONTENTS

<b>PRODUCT OVERVIEW</b>	<b>1</b>
<b>FEATURES</b>	<b>1</b>
<b>PACKING LIST</b>	<b>1</b>
<b>MAIN PARTS AND CONTROL INTERFACES</b>	<b>1</b>
<b>REMOTE CONTROL</b>	<b>3</b>
<b>INSTALLATION</b>	<b>5</b>
<b>DESKTOP MOUNT INSTALLATION</b>	<b>5</b>
<b>WALL MOUNT INSTALLATION</b>	<b>5</b>
<b>CABLE CONNECTING</b>	<b>6</b>
<b>AMCAP CAPTURE SOFTWARE</b>	<b>7</b>
<b>DRIVER INSTALLATION OF USB VIRTUAL SERIAL PORT</b>	<b>7</b>
<b>ANNEX 1 TECHNICAL SPECIFICATIONS</b>	<b>8</b>
<b>ANNEX 2 SIZE AND DIMENSION</b>	<b>9</b>
<b>TROUBLESHOOTING</b>	<b>10</b>





# Main Parts And Control Interfaces

## PTZ Camera

### Front View

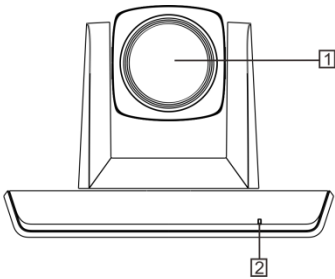

1 Camera Module

2 Power Indicator

### Bottom View

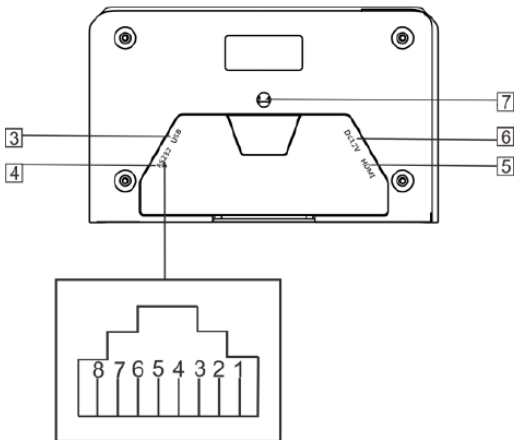

3 USB

4 RS-232

2

5 HDMI

6 Power ( DC12V )

7 Installation Hole

1/4" inch screw, used to fix the camera

Pin Definition Of Control Port	
Pin No	Definition
1	/
2	/
3	RXD
4	GXD
5	/
6	TXD
7	/
8	/



# Remote Control

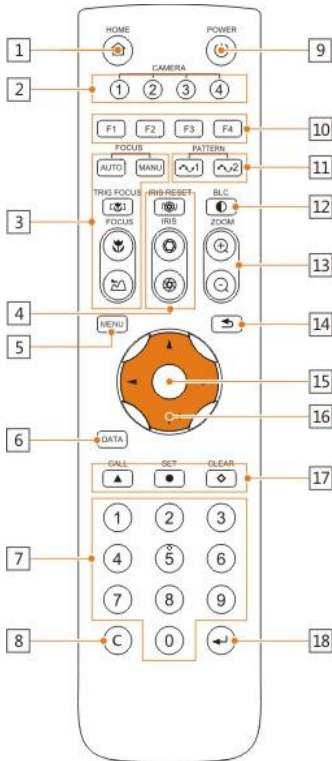

## 1 HOME button

Press **HOME** button, camera moves to initial position where both pan and tilt angle is zero.

## 2 Camera Selection Button

Used to switch among 4 cameras, press 1-4 number buttons to control cameras with 1-4 address respectively. For example, press button 1 to control the camera with address 1.

## 3 Focus

Camera does not support this feature.

## 4 Iris

Press “” button to reset brightness value to default. “” button to increase brightness, “” button to decrease brightness.

## 5 Menu

Camera does not support this feature.

## 6 Data

Camera does not support this feature.

## 7 Number Keys

Used to input numbers, for example, preset number.

## 8 Cancel

Used to delete number inputted.

## 9 Power

After the camera has been connected to power source, press this button to turn on / off the camera.

## 10 Reserved Buttons ( F1, F2, F3, F4 )

These buttons are reserved for future use.

## 11 Pattern

Camera does not support this feature.

## 12 BLC

Used to open / close back light compensation.

### 13 Zoom

Used to adjust zooming times.

“” button to zoom in

“” button to zoom out.

### 14 Back

Camera does not support this feature.

### 15 OK

Press this button to switch among pan / tilt control speeds.

### 16 Direction Operation

Press these four buttons to pan left/right and tilt up/down.

### 17 Preset Setting

“” button to call a preset.

Input number key(s), and then press this button to call a preset.

“” button to set a preset.

Move the camera to a specific position, adjust focus value and etc., and then press this button to set a preset.

“” button to clear a preset.

Input number key(s), and then press this button to clear a preset.

### 18 Enter

After inputting numbers, press this button to confirm.

# INSTALLATION

The camera has 2 installation types:  
desktop, wall (optional) installations.

## Note

- Make sure the installed place is strong and safe enough to hold the camera and relative parts, it is suggested that the installed place can withstand 4 times the weight of the camera and its relative parts

## Desktop Mount Installation

1. Put the camera on a flat surface. In case the camera has to be placed on an inclined surface, make sure the cline angle is less than 15 degrees to ensure proper pan /tilt operation.

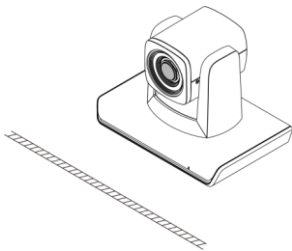

## Note

- Take effective measures to avoid camera from dropping.
- Do not grab the camera head when carrying.
- Do not rotate the camera head with hand. It may cause malfunction to the camera.

## Wall Mount Installation

( optional )

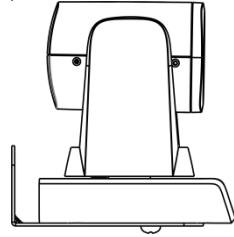

1. According to diameter and position of the 2 installation holes (As shown below) on the bracket, drill 2 holes on the wall and fix the bracket.

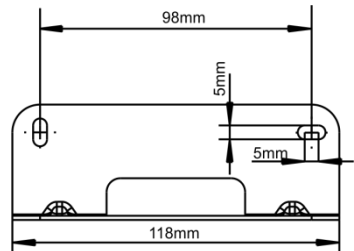

2. Before fixing the camera, set the DIP switches of the camera correctly.
3. Use inch screws to fix the camera on the bracket, fix the limitscrew .According to actual requirement, and make sure the camera is tightly fixed onto the bracket before your hands leave the camera.

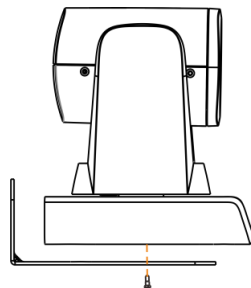

## CABLE CONNECTING

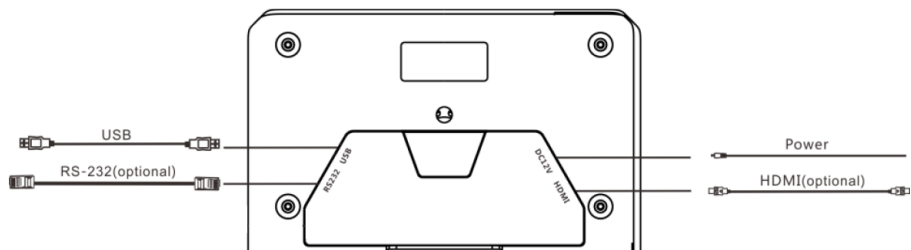

### Note

- If preset 0 has been saved, after powered on, camera moves to preset 0 automatically; if preset 0 has not been saved, after powered on, camera moves to Home position, where both pan and tilt angle is zero and zooming time is 1x.

---

# AMCAP CAPTURE

## SOFTWARE

Open software, choose “USB”, from “Options”, tick “Preview” to view camera image.

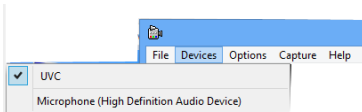

To change frame rate or resolution, go to “Capture” / “Set Frame Rate” / “Use Frame Rate” and change value accordingly.

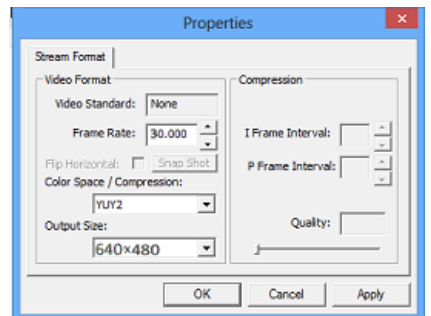
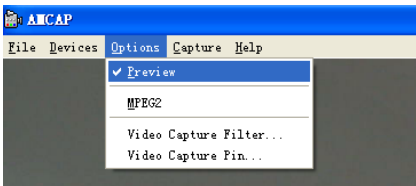
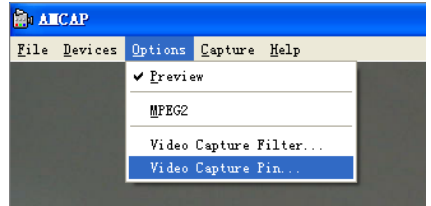

If frame rate is not enough, go to “Capture” / “Set Frame Rate” / “Use Frame Rate” and disable it.

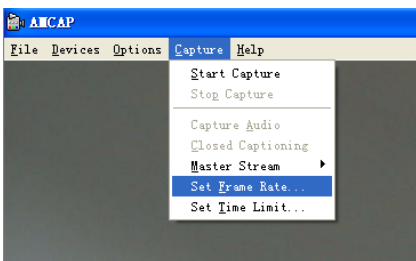

---

## DRIVER INSTALLATION OF USB VIRTUAL SERIAL PORT

The camera supports one USB virtual serial port at the same time, with which the camera can be controlled via RS-232 cable. Driver installation is required. Before installation, the USB connection between PC and the camera needs be removed.

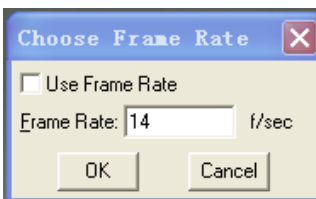

# ANNEX 1 TECHNICAL SPECIFICATIONS

<b>VIDEO</b>		
Image Sensor	1/2.8" CMOS, 2.16megapixel	
Optical Zoom	3X, f=3.35.-10.05mm, F1.7-F3.0	10X, f=5.15-47.38mm, F2.38
Field of View	99.6°-30.6°	62.2°-7.08°
Focus System	Auto, Manual, PTZ Trigger, One Push Trigger	
Exposure Control	Auto/ Manual	
White Balance	Auto, Manual, One Push Triggere, Auto Tracking	
Min. illumination	0.5 lux (color), 0.1Lux (B/W)	
Gain	Auto /Manual	
Shutter Speed	1/25 to 1/10,000s	
BLC	Support	
DNR	2D/3D	
S/N Rate	≥50dB	
<b>PTZ</b>		
Pan Angle	-90°~+90°	
Tilt Angle	-30°~+90°	
Pan Speed	15°/S	
Tilt Speed	10°/S	
Preset Number	32	
<b>Interface</b>		
HDMI Port	1920x1080P30	
Control Interface	RS-232	
IR Remote Control	Support	
<b>USB</b>		
Resolution	Max Support 1920*1080@30fps	
Image Compression	H.264/MJPEG	
UVC Protocol	USB2.0, UVC 1.0~UVC 1.4	
UVC PTZ Control	Support	
<b>General</b>		
Power	DC12V	
Power Consumption	< 5W	
Operating Temperature	0°C ~ + 40°C	
Storage Temperature	-20°C~+60°C	
Dimensions (WxDxH)	163 mmx101 mmx114mm	
Weight	0.6KG	
Body Color	Black	

# ANNEX 2 SIZE AND DIMENSION

**Front**

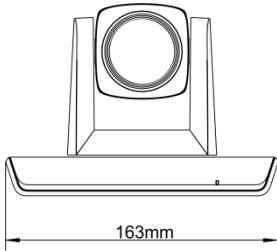

**Rear**

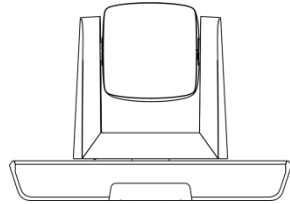

**Top**

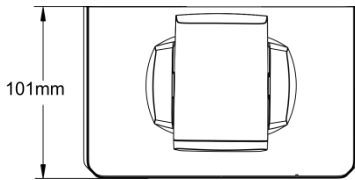

**Side**

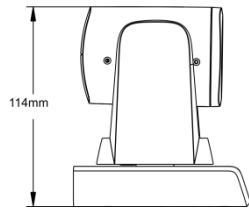

**Bottom**

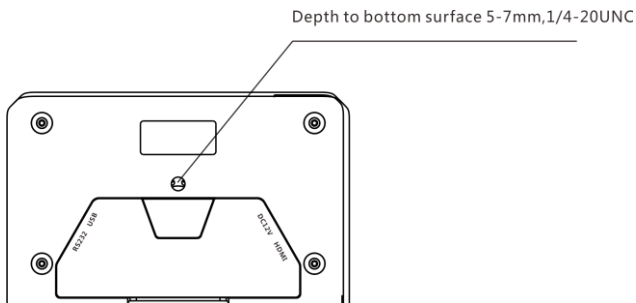

---

## TROUBLESHOOTING

Problem	Possible Cause	Solution
No action or image after powered on, No self-testing after powered on, or with motor noise	Power supply failure	Check power supply
	USB cable failure	Replace USB cable
	Use non-standard USB cable, the cable is too long	Add an external power supply, or add a USB HUB for external power supply
	Mechanical failure	Repair
Not controllable from remote controller	Low battery of remote controller	Change battery for remote controller
	Exceed remote control distance	Control within distance of 8M
After power on, self-test successfully, but not controllable	Wrong address / protocol / baud rate	Check & set again
	Wrong connection or open circuit of RS-232 cable	Check & reconnect









**The user manual is only for reference, it is subject to changes, please ask for the latest version from your supplier.**