



DIGITAL RACK MIXER M32R

Digital Console for Live and Studio with 40 Input Channels,
16 Midas PRO Microphone Preamplifiers and 25 Mix Buses

Table of Contents

Precautions	10
Introduction	11
1. Control Surface	12
1.1 Channel Strip - Input Channels	12
1.2 Channel Strip - Group/Bus Channels	13
1.3 Config/Preamplifier	14
1.4 Gate.....	14
1.5 Dynamics	14
1.6 Equaliser	15
1.7 Main Bus.....	16
1.8 Recorder.....	16
1.9 Main Display (Summary)	17
1.10 Monitor.....	19
1.11 Talkback.....	20
1.12 Assign.....	21
1.13 Fader Layer.....	22
2. Main Display	23
2.1 Main Display - Top Section	23
2.2 Meters.....	27
2.3 Routing.....	28
2.4 Library.....	32
2.5 Effects	32
2.6 Setup.....	34
2.7 Monitor.....	36
2.8 Scenes.....	36
2.9 Mute Group.....	39
2.10 Utility.....	39
2.11 Internal Effects	40
3. Rear Panel	50
3.1 MONITOR / CONTROL ROOM OUT	50
3.2 AC / POWER	50
3.3 XLR OUT 1-8.....	50
3.4 XLR IN 1-16.....	50
3.5 Klark Teknik DN32-USB	51
3.6 REMOTE CONTROL.....	51
3.7 MIDI	51
3.8 ULTRANET.....	51
3.9 AES50	51
3.10 AUX IN / OUT	51
4. Appendices	52
4.1 Appendix A: Technical Specifications.....	52
4.2 Appendix B: MIDI Operation	53
4.3 Appendix C: Dimensions	56
4.4 Appendix D: Block Diagram.....	58
4.5 Appendix E: Service Information	59
4.6 Appendix F: Glossary.....	59

EN Important Safety Instructions



Terminals marked with this symbol carry electrical current of sufficient magnitude to constitute risk of electric shock.

Use only high-quality professional speaker cables with ¼" TS or twist-locking plugs pre-installed. All other installation or modification should be performed only by qualified personnel.



This symbol, wherever it appears, alerts you to the presence of uninsulated dangerous voltage inside the enclosure - voltage that may be sufficient to constitute a risk of shock.



This symbol, wherever it appears, alerts you to important operating and maintenance instructions in the accompanying literature. Please read the manual.



Caution

To reduce the risk of electric shock, do not remove the top cover (or the rear section). No user serviceable parts inside. Refer servicing to qualified personnel.



Caution

To reduce the risk of fire or electric shock, do not expose this appliance to rain and moisture. The apparatus shall not be exposed to dripping or splashing liquids and no objects filled with liquids, such as vases, shall be placed on the apparatus.



Caution

These service instructions are for use by qualified service personnel only. To reduce the risk of electric shock do not perform any servicing other than that contained in the operation instructions. Repairs have to be performed by qualified service personnel.

1. Read these instructions.
2. Keep these instructions.
3. Heed all warnings.
4. Follow all instructions.
5. Do not use this apparatus near water.
6. Clean only with dry cloth.
7. Do not block any ventilation openings. Install in accordance with the manufacturer's instructions.
8. Do not install near any heat sources such as radiators, heat registers, stoves, or other apparatus (including amplifiers) that produce heat.

9. Do not defeat the safety purpose of the polarized or grounding-type plug. A polarized plug has two blades with one wider than the other. A grounding-type plug has two blades and a third grounding prong. The wide blade or the third prong are provided for your safety. If the provided plug does not fit into your outlet, consult an electrician for replacement of the obsolete outlet.

10. Protect the power cord from being walked on or pinched particularly at plugs, convenience receptacles, and the point where they exit from the apparatus.

11. Use only attachments/accessories specified by the manufacturer.



12. Use only with the cart, stand, tripod, bracket, or table specified by the manufacturer, or sold with the apparatus. When a cart is used, use caution when moving the cart/apparatus combination to avoid

injury from tip-over.

13. Unplug this apparatus during lightning storms or when unused for long periods of time.

14. Refer all servicing to qualified service personnel. Servicing is required when the apparatus has been damaged in any way, such as power supply cord or plug is damaged, liquid has been spilled or objects have fallen into the apparatus, the apparatus has been exposed to rain or moisture, does not operate normally, or has been dropped.

15. The apparatus shall be connected to a MAINS socket outlet with a protective earthing connection.

16. Where the MAINS plug or an appliance coupler is used as the disconnect device, the disconnect device shall remain readily operable.



17. Correct disposal of this product: This symbol indicates that this product must not be disposed of with household waste, according to the WEEE Directive (2012/19/EU) and your national law. This product should be taken

to a collection center licensed for the recycling of waste electrical and electronic equipment (EEE). The mishandling of this type of waste could have a possible negative impact on the environment and human health due to potentially hazardous substances that are generally associated with EEE. At the same time, your cooperation in the correct disposal of this product will contribute to the efficient use of natural resources. For more information about where you can take your waste equipment for recycling, please contact your local city office, or your household waste collection service.

18. Do not install in a confined space, such as a book case or similar unit.

19. Do not place naked flame sources, such as lighted candles, on the apparatus.

20. Please keep the environmental aspects of battery disposal in mind. Batteries must be disposed-of at a battery collection point.

21. Use this apparatus in tropical and/or moderate climates.

LEGAL DISCLAIMER

Music Tribe accepts no liability for any loss which may be suffered by any person who relies either wholly or in part upon any description, photograph, or statement contained herein. Technical specifications, appearances and other information are subject to change without notice. All trademarks are the property of their respective owners. Midas, Klark Teknik, Lab Gruppen, Lake, Tannoy, Turbosound, TC Electronic, TC Helicon, Behringer, Bugera and Coolaudio are trademarks or registered trademarks of Music Tribe Global Brands Ltd. © Music Tribe Global Brands Ltd. 2019 All rights reserved.

LIMITED WARRANTY

For the applicable warranty terms and conditions and additional information regarding Music Tribe's Limited Warranty, please see complete details online at musictribe.com/warranty.

Zhongshan Eurotec Electronics Limited

No. 10 Wanmei Road, South China Modern Chinese Medicine Park, Nanlang Town, 528451, Zhongshan City, Guangdong Province, China

ES Instrucciones de seguridad

Las terminales marcadas con este símbolo transportan corriente eléctrica de magnitud suficiente como para constituir un riesgo de descarga eléctrica. Utilice solo cables de altavoz profesionales y de alta calidad con conectores TS de 6,3 mm o de bayoneta prefijados. Cualquier otra instalación o modificación debe ser realizada únicamente por un técnico cualificado.



Este símbolo, siempre que aparece, le advierte de la presencia de voltaje peligroso sin aislar dentro de la caja; este voltaje puede ser suficiente para constituir un riesgo de descarga.



Este símbolo, siempre que aparece, le advierte sobre instrucciones operativas y de mantenimiento que aparecen en la documentación adjunta. Por favor, lea el manual.

**Atención**

Para reducir el riesgo de descarga eléctrica, no quite la tapa (o la parte posterior). No hay piezas en el interior del equipo que puedan ser reparadas por el usuario. Si es necesario, póngase en contacto con personal cualificado.

**Atención**

Para reducir el riesgo de incendio o descarga eléctrica, no exponga este aparato a la lluvia, humedad o alguna otra fuente que pueda salpicar o derramar algún líquido sobre el aparato. No coloque ningún tipo de recipiente para líquidos sobre el aparato.

**Atención**

Las instrucciones de servicio deben llevarlas a cabo exclusivamente personal cualificado. Para evitar el riesgo de una descarga eléctrica, no realice reparaciones que no se encuentren descritas en el manual de operaciones. Las reparaciones deben ser realizadas exclusivamente por personal cualificado.

1. Lea las instrucciones.
2. Conserve estas instrucciones.
3. Preste atención a todas las advertencias.
4. Siga todas las instrucciones.
5. No use este aparato cerca del agua.
6. Limpie este aparato con un paño seco.
7. No bloquee las aberturas de ventilación. Instale el equipo de acuerdo con las instrucciones del fabricante.
8. No instale este equipo cerca de fuentes de calor tales como radiadores, acumuladores de calor, estufas u otros aparatos (incluyendo amplificadores) que puedan producir calor.

9. No elimine o deshabilite nunca la conexión a tierra del aparato o del cable de alimentación de corriente. Un enchufe polarizado tiene dos polos, uno de los cuales tiene un contacto más ancho que el otro. Una clavija con puesta a tierra dispone de tres contactos: dos polos y la puesta a tierra. El contacto ancho y el tercer contacto, respectivamente, son los que garantizan una mayor seguridad. Si el enchufe suministrado con el equipo no concuerda con la toma de corriente, consulte con un electricista para cambiar la toma de corriente obsoleta.

10. Coloque el cable de suministro de energía de manera que no pueda ser pisado y que esté protegido de objetos afilados. Asegúrese de que el cable de suministro de energía esté protegido, especialmente en la zona de la clavija y en el punto donde sale del aparato.

11. Use únicamente los dispositivos o accesorios especificados por el fabricante.



12. Use únicamente la carretilla, plataforma, trípode, soporte o mesa especificados por el fabricante o suministrados junto con el equipo. Al transportar el equipo, tenga cuidado para evitar

daños y caídas al tropezar con algún obstáculo.

13. Desenchufe el equipo durante tormentas o si no va a utilizarlo durante un periodo largo.

14. Confíe las reparaciones únicamente a servicios técnicos cualificados. La unidad requiere mantenimiento siempre que haya sufrido algún daño, si el cable de suministro de energía o el enchufe presentaran daños, se hubiera derramado un líquido o hubieran caído objetos dentro del equipo, si el aparato hubiera estado expuesto a la humedad o la lluvia, si ha dejado de funcionar de manera normal o si ha sufrido algún golpe o caída.

15. Al conectar la unidad a la toma de corriente eléctrica asegúrese de que la conexión disponga de una unión a tierra.

16. Si el enchufe o conector de red sirve como único medio de desconexión, éste debe ser accesible fácilmente.



17. Cómo debe deshacerse de este aparato: Este símbolo indica que este aparato no debe ser tratado como basura orgánica, según lo indicado en la Directiva WEEE (2012/19/EU) y a las normativas aplicables en su país.

En lugar de ello deberá llevarlo al punto limpio más cercano para el reciclaje de sus elementos eléctricos / electrónicos (EEE). Al hacer esto estará ayudando a prevenir las posibles consecuencias negativas para el medio ambiente y la salud que podrían ser provocadas por una gestión inadecuada de este tipo de aparatos. Además, el reciclaje de materiales ayudará a conservar los recursos naturales. Para más información acerca del reciclaje de este aparato, póngase en contacto con el Ayuntamiento de su ciudad o con el punto limpio local.

18. No instale esta unidad en un espacio muy reducido, tal como encastrada en una librería o similar.

19. No coloque objetos con llama, como una vela encendida, sobre este aparato.

20. Tenga presentes todas las advertencias relativas al reciclaje y correcta eliminación de las pilas. Las pilas deben ser siempre eliminadas en un punto limpio y nunca con el resto de la basura orgánica.

21. Use este aparato en rangos de temperatura moderados y/o tropicales.

NEGACIÓN LEGAL

Music Tribe no admite ningún tipo de responsabilidad por cualquier daño o pérdida que pudiera sufrir cualquier persona por confiar total o parcialmente en la descripciones, fotografías o afirmaciones contenidas en este documento. Las especificaciones técnicas, imágenes y otras informaciones contenidas en este documento están sujetas a modificaciones sin previo aviso. Todas las marcas comerciales que aparecen aquí son propiedad de sus respectivos dueños. Midas, Klark Teknik, Lab Gruppen, Lake, Tannoy, Turbosound, TC Electronic, TC Helicon, Behringer, Bugera y Coolaudio son marcas comerciales o marcas registradas de Music Tribe Global Brands Ltd. © Music Tribe Global Brands Ltd. 2019 Reservados todos los derechos.

GARANTÍA LIMITADA

Si quiere conocer los detalles y condiciones aplicables de la garantía así como información adicional sobre la Garantía limitada de Music Tribe, consulte online toda la información en la web musictribe.com/warranty.

FR Consignes de sécurité

Les points repérés par ce symbole portent une tension électrique suffisante pour constituer un risque d'électrocution.

Utilisez uniquement des câbles d'enceintes professionnels de haute qualité avec fiches Jack mono 6,35 mm ou fiches à verrouillages déjà installées. Toute autre installation ou modification doit être effectuée uniquement par un personnel qualifié.



Ce symbole avertit de la présence d'une tension dangereuse et non isolée à l'intérieur de l'appareil - elle peut provoquer des chocs électriques.

**Attention**

Ce symbole signale les consignes d'utilisation et d'entre ! Tien importantes dans la documentation fournie. Lisez les consignes de sécurité du manuel d'utilisation de l'appareil.

**Attention**

Pour éviter tout risque de choc électrique, ne pas ouvrir le capot de l'appareil ni démonter le panneau arrière. L'intérieur de l'appareil ne possède aucun élément réparable par l'utilisateur. Laisser toute réparation à un professionnel qualifié.

**Attention**

Pour réduire les risques de feu et de choc électrique, n'exposez pas cet appareil à la pluie, à la moisissure, aux gouttes ou aux éclaboussures. Ne posez pas de récipient contenant un liquide sur l'appareil (un vase par exemple).

**Attention**

Ces consignes de sécurité et d'entretien sont destinées à un personnel qualifié. Pour éviter tout risque de choc électrique, n'effectuez aucune réparation sur l'appareil qui ne soit décrite par le manuel d'utilisation. Les éventuelles réparations doivent être effectuées uniquement par un technicien spécialisé.

1. Lisez ces consignes.
2. Conservez ces consignes.
3. Respectez tous les avertissements.
4. Respectez toutes les consignes d'utilisation.
5. N'utilisez jamais l'appareil à proximité d'un liquide.
6. Nettoyez l'appareil avec un chiffon sec.
7. Veillez à ne pas empêcher la bonne ventilation de l'appareil via ses ouïes de ventilation. Respectez les consignes du fabricant concernant l'installation de l'appareil.
8. Ne placez pas l'appareil à proximité d'une source de chaleur telle qu'un chauffage, une cuisinière ou tout appareil dégageant de la chaleur (y compris un ampli de puissance).

9. Ne supprimez jamais la sécurité des prises bipolaires ou des prises terre. Les prises bipolaires possèdent deux contacts de largeur différente. Le plus large est le contact de sécurité. Les prises terre possèdent deux contacts plus une mise à la terre servant de sécurité. Si la prise du bloc d'alimentation ou du cordon d'alimentation fourni ne correspond pas à celles de votre installation électrique, faites appel à un électricien pour effectuer le changement de prise.

10. Installez le cordon d'alimentation de telle façon que personne ne puisse marcher dessus et qu'il soit protégé d'arêtes coupantes. Assurez-vous que le cordon d'alimentation est suffisamment protégé, notamment au niveau de sa prise électrique et de l'endroit où il est relié à l'appareil; cela est également valable pour une éventuelle rallonge électrique.

11. Utilisez exclusivement des accessoires et des appareils supplémentaires recommandés par le fabricant.



12. Utilisez exclusivement des chariots, des diables, des présentoirs, des pieds et des surfaces de travail recommandés par le fabricant ou livrés avec le produit.

Déplacez précautionneusement tout chariot ou diable chargé pour éviter d'éventuelles blessures en cas de chute.

13. Débranchez l'appareil de la tension secteur en cas d'orage ou si l'appareil reste inutilisé pendant une longue période de temps.

14. Les travaux d'entretien de l'appareil doivent être effectués uniquement par du personnel qualifié. Aucun entretien n'est nécessaire sauf si l'appareil est endommagé de quelque façon que ce soit (dommages sur le cordon d'alimentation ou la prise par exemple), si un liquide ou un objet a pénétré à l'intérieur du châssis, si l'appareil a été exposé à la pluie ou à l'humidité, s'il ne fonctionne pas correctement ou à la suite d'une chute.

15. L'appareil doit être connecté à une prise secteur dotée d'une protection par mise à la terre.

16. La prise électrique ou la prise IEC de tout appareil dénué de bouton marche/arrêt doit rester accessible en permanence.



17. Mise au rebut appropriée de ce produit: Ce symbole indique qu'en accord avec la directive DEEE (2012/19/EU) et les lois en vigueur dans votre pays, ce produit ne doit pas être jeté avec les déchets ménagers. Ce produit doit être déposé dans un point de collecte agréé pour le recyclage des déchets d'équipements électriques et électroniques (EEE). Une mauvaise manipulation de ce type de déchets pourrait avoir un impact négatif sur l'environnement et la santé à cause des substances potentiellement dangereuses généralement associées à ces équipements. En même temps, votre coopération dans la mise au rebut de ce produit contribuera à l'utilisation efficace des ressources naturelles. Pour plus d'informations sur l'endroit où vous pouvez déposer vos déchets

d'équipements pour le recyclage, veuillez contacter votre mairie ou votre centre local de collecte des déchets.

18. N'installez pas l'appareil dans un espace confiné tel qu'une bibliothèque ou meuble similaire.

19. Ne placez jamais d'objets enflammés, tels que des bougies allumées, sur l'appareil.

20. Gardez à l'esprit l'impact environnemental lorsque vous mettez des piles au rebut. Les piles usées doivent être déposées dans un point de collecte adapté.

21. Utilisez l'appareil dans un climat tropical et/ou modéré.

ES

FR

DÉNI LÉGAL

Music Tribe ne peut être tenu pour responsable pour toute perte pouvant être subie par toute personne se fiant en partie ou en totalité à toute description, photographie ou affirmation contenue dans ce document. Les caractéristiques, l'apparence et d'autres informations peuvent faire l'objet de modifications sans notification. Toutes les marques appartiennent à leurs propriétaires respectifs. Midas, Klark Teknik, Lab Gruppen, Lake, Tannoy, Turbosound, TC Electronic, TC Helicon, Behringer, Bugera et Coolaudio sont des marques ou marques déposées de Music Tribe Global Brands Ltd. © Music Tribe Global Brands Ltd. 2019 Tous droits réservés.

GARANTIE LIMITÉE

Pour connaître les termes et conditions de garantie applicables, ainsi que les informations supplémentaires et détaillées sur la Garantie Limitée de Music Tribe, consultez le site Internet musictribe.com/warranty.

DE Wichtige Sicherheitshinweise



Vorsicht

Die mit dem Symbol markierten Anschlüsse führen so viel Spannung, dass die Gefahr eines Stromschlags besteht. Verwenden Sie nur hochwertige, professionelle Lautsprecherkabel mit vorinstallierten 6,35 mm MONO-Klinkensteckern oder Lautsprecherstecker mit Drehverriegelung. Alle anderen Installationen oder Modifikationen sollten nur von qualifiziertem Fachpersonal ausgeführt werden.



Achtung

Um eine Gefährdung durch Stromschlag auszuschließen, darf die Geräteabdeckung bzw. Geräterückwand nicht abgenommen werden. Im Innern des Geräts befinden sich keine vom Benutzer reparierbaren Teile. Reparaturarbeiten dürfen nur von qualifiziertem Personal ausgeführt werden.



Achtung

Um eine Gefährdung durch Feuer bzw. Stromschlag auszuschließen, darf dieses Gerät weder Regen oder Feuchtigkeit ausgesetzt werden noch sollten Spritzwasser oder tropfende Flüssigkeiten in das Gerät gelangen können. Stellen Sie keine mit Flüssigkeit gefüllten Gegenstände, wie z. B. Vasen, auf das Gerät.



Achtung

Die Service-Hinweise sind nur durch qualifiziertes Personal zu befolgen. Um eine Gefährdung durch Stromschlag zu vermeiden, führen Sie bitte keinerlei Reparaturen an dem Gerät durch, die nicht in der Bedienungsanleitung beschrieben sind. Reparaturen sind nur von qualifiziertem Fachpersonal durchzuführen.

1. Lesen Sie diese Hinweise.
2. Bewahren Sie diese Hinweise auf.
3. Beachten Sie alle Warnhinweise.
4. Befolgen Sie alle Bedienungshinweise.
5. Betreiben Sie das Gerät nicht in der Nähe von Wasser.
6. Reinigen Sie das Gerät mit einem trockenen Tuch.
7. Blockieren Sie nicht die Belüftungsschlitze. Beachten Sie beim Einbau des Gerätes die Herstellerhinweise.
8. Stellen Sie das Gerät nicht in der Nähe von Wärmequellen auf. Solche Wärmequellen sind z. B. Heizkörper, Herde oder andere Wärme erzeugende Geräte (auch Verstärker).
9. Entfernen Sie in keinem Fall die Sicherheitsvorrichtung von Zweipol- oder geerdeten Steckern. Ein Zweipolstecker hat zwei unterschiedlich breite Steckkontakte. Ein geerdeter Stecker hat zwei Steckkontakte und einen dritten Erdungskontakt. Der breitere Steckkontakt oder der zusätzliche

Erdungskontakt dient Ihrer Sicherheit. Falls das mitgelieferte Steckerformat nicht zu Ihrer Steckdose passt, wenden Sie sich bitte an einen Elektriker, damit die Steckdose entsprechend ausgetauscht wird.

10. Verlegen Sie das Netzkabel so, dass es vor Tritten und scharfen Kanten geschützt ist und nicht beschädigt werden kann. Achten Sie bitte insbesondere im Bereich der Stecker, Verlängerungskabel und an der Stelle, an der das Netzkabel das Gerät verlässt, auf ausreichenden Schutz.
11. Das Gerät muss jederzeit mit intaktem Schutzleiter an das Stromnetz angeschlossen sein.
12. Sollte der Hauptnetzstecker oder eine Gerätesteckdose die Funktionseinheit zum Abschalten sein, muss diese immer zugänglich sein.
13. Verwenden Sie nur Zusatzgeräte/Zubehörteile, die laut Hersteller geeignet sind.



14. Verwenden Sie nur Wagen, Standvorrichtungen, Stative, Halter oder Tische, die vom Hersteller benannt oder im Lieferumfang des Geräts enthalten sind. Falls Sie einen

Wagen benutzen, seien Sie vorsichtig beim Bewegen der Wagen-Gerätkombination, um Verletzungen durch Stolpern zu vermeiden.

15. Ziehen Sie den Netzstecker bei Gewitter oder wenn Sie das Gerät längere Zeit nicht benutzen.
16. Lassen Sie alle Wartungsarbeiten nur von qualifiziertem Service-Personal ausführen. Eine Wartung ist notwendig, wenn das Gerät in irgendeiner Weise beschädigt wurde (z. B. Beschädigung des Netzkabels oder Steckers), Gegenstände oder Flüssigkeit in das Geräterinnere gelangt sind, das Gerät Regen oder Feuchtigkeit ausgesetzt wurde, das Gerät nicht ordnungsgemäß funktioniert oder auf den Boden gefallen ist.



17. Korrekte Entsorgung dieses Produkts: Dieses Symbol weist darauf hin, das Produkt entsprechend der WEEE Richtlinie (2012/19/EU) und der jeweiligen nationalen Gesetze nicht zusammen mit Ihren

Haushaltsabfällen zu entsorgen. Dieses Produkt sollte bei einer autorisierten Sammelstelle für Recycling elektrischer und elektronischer Geräte (EEE) abgegeben werden. Wegen bedenklicher Substanzen, die generell mit elektrischen und elektronischen Geräten in Verbindung stehen, könnte eine unsachgemäße Behandlung dieser Abfallart eine negative Auswirkung auf Umwelt und Gesundheit haben. Gleichzeitig gewährleistet Ihr Beitrag zur richtigen Entsorgung dieses Produkts die effektive Nutzung natürlicher Ressourcen. Für weitere Informationen zur Entsorgung Ihrer Geräte bei einer Recycling-Stelle nehmen Sie bitte Kontakt zum zuständigen städtischen Büro, Entsorgungsamt oder zu Ihrem Haushaltsabfallentsorger auf.

18. Installieren Sie das Gerät nicht in einer beengten Umgebung, zum Beispiel Bücherregal oder ähnliches.
19. Stellen Sie keine Gegenstände mit offenen Flammen, etwa brennende Kerzen, auf das Gerät.
20. Beachten Sie bei der Entsorgung von Batterien den Umweltschutz-Aspekt. Batterien müssen bei einer Batterie-Sammelstelle entsorgt werden.
21. Verwenden Sie das Gerät in tropischen und/oder gemäßigten Klimazonen.

HAFTUNGSAUSSCHLUSS

Music Tribe übernimmt keine Haftung für Verluste, die Personen entstanden sind, die sich ganz oder teilweise auf hier enthaltene Beschreibungen, Fotos oder Aussagen verlassen haben. Technische Daten, Erscheinungsbild und andere Informationen können ohne vorherige Ankündigung geändert werden. Alle Warenzeichen sind Eigentum der jeweiligen Inhaber. Midas, Klark Teknik, Lab Gruppen, Lake, Tannoy, Turbosound, TC Electronic, TC Helicon, Behringer, Bugera und Coolaudio sind Warenzeichen oder eingetragene Warenzeichen der Music Tribe Global Brands Ltd. © Music Tribe Global Brands Ltd. 2019 Alle Rechte vorbehalten.

BESCHRÄNKTE GARANTIE

Die geltenden Garantiebedingungen und zusätzliche Informationen bezüglich der von Music Tribe gewährten beschränkten Garantie finden Sie online unter musictribe.com/warranty.

PT Instruções de Segurança Importantes**Aviso!**

Terminais marcados com o símbolo carregam corrente elétrica de magnitude suficiente para constituir um risco de choque elétrico. Use apenas cabos de alto-falantes de alta qualidade com plugues TS de ¼" ou plugues com trava de torção pré-instalados. Todas as outras instalações e modificações devem ser efetuadas por pessoas qualificadas.



Este símbolo, onde quer que o encontre, alerta-o para a leitura das instruções de manuseamento que acompanham o equipamento. Por favor leia o manual de instruções.

**Atenção**

De forma a diminuir o risco de choque eléctrico, não remover a cobertura (ou a secção de trás). Não existem peças substituíveis por parte do utilizador no seu interior. Para esse efeito recorrer a um técnico qualificado.

**Atenção**

Para reduzir o risco de incêndios ou choques eléctricos o aparelho não deve ser exposto à chuva nem à humidade. Além disso, não deve ser sujeito a salpicos, nem devem ser colocados em cima do aparelho objectos contendo líquidos, tais como jarras.

**Atenção**

Estas instruções de operação devem ser utilizadas, em exclusivo, por técnicos de assistência qualificados. Para evitar choques eléctricos não proceda a reparações ou intervenções, que não as indicadas nas instruções de operação, salvo se possuir as qualificações necessárias. Para evitar choques eléctricos não proceda a reparações ou intervenções, que não as indicadas nas instruções de operação. Só o deverá fazer se possuir as qualificações necessárias.

1. Leia estas instruções.
2. Guarde estas instruções.
3. Preste atenção a todos os avisos.
4. Siga todas as instruções.
5. Não utilize este dispositivo perto de água.
6. Limpe apenas com um pano seco.
7. Não obstrua as entradas de ventilação. Instale de acordo com as instruções do fabricante.
8. Não instale perto de quaisquer fontes de calor tais como radiadores, bocas de ar quente, fogões de sala ou outros aparelhos (incluindo amplificadores) que produzam calor.
9. Não anule o objectivo de segurança das fichas polarizadas ou do tipo de ligação à terra. Uma ficha polarizada dispõe de duas palhetas sendo uma mais larga do que a outra. Uma ficha do tipo ligação à terra dispõe

de duas palhetas e um terceiro dente de ligação à terra. A palheta larga ou o terceiro dente são fornecidos para sua segurança. Se a ficha fornecida não encaixar na sua tomada, consulte um electricista para a substituição da tomada obsoleta.

10. Proteja o cabo de alimentação de pisadelas ou apertos, especialmente nas fichas, extensões, e no local de saída da unidade. Certifique-se de que o cabo eléctrico está protegido. Verifique particularmente nas fichas, nos receptáculos e no ponto em que o cabo sai do aparelho.
11. O aparelho tem de estar sempre conectado à rede eléctrica com o condutor de protecção intacto.
12. Se utilizar uma ficha de rede principal ou uma tomada de aparelhos para desligar a unidade de funcionamento, esta deve estar sempre acessível.
13. Utilize apenas ligações/acessórios especificados pelo fabricante.



14. Utilize apenas com o carrinho, estrutura, tripé, suporte, ou mesa especificados pelo fabricante ou vendidos com o dispositivo. Quando utilizar um carrinho, tenha cuidado ao

mover o conjunto carrinho/dispositivo para evitar danos provocados pela terpidação.

15. Desligue este dispositivo durante as trovoadas ou quando não for utilizado durante longos períodos de tempo.
16. Qualquer tipo de reparação deve ser sempre efectuado por pessoal qualificado. É necessária uma reparação sempre que a unidade tiver sido de alguma forma danificada, como por exemplo: no caso do cabo de alimentação ou ficha se encontrarem danificados; na eventualidade de líquido ter sido derramado ou objectos terem caído para dentro do dispositivo; no caso da unidade ter estado exposta à chuva ou à humidade; se esta não funcionar normalmente, ou se tiver caído.



17. Correcta eliminação deste produto: este símbolo indica que o produto não deve ser eliminado juntamente com os resíduos domésticos, segundo a Directiva REEE (2012/19/EU) e a legislação nacional. Este produto deverá ser levado para um centro de recolha licenciado para a reciclagem de resíduos de equipamentos eléctricos e electrónicos (EEE). O tratamento incorrecto deste tipo de resíduos pode ter um eventual impacto negativo no ambiente e na saúde humana devido a substâncias potencialmente perigosas que estão geralmente associadas aos EEE. Ao mesmo tempo, a sua colaboração para a eliminação correcta deste produto irá contribuir para a utilização eficiente dos recursos naturais. Para mais informação acerca dos locais onde poderá deixar o seu equipamento usado para reciclagem, é favor contactar os serviços municipais locais, a entidade de gestão de resíduos ou os serviços de recolha de resíduos domésticos.

18. Não instale em lugares confinados, tais como estantes ou unidades similares.

19. Não coloque fontes de chama, tais como velas acesas, sobre o aparelho.

20. Favor, obedecer os aspectos ambientais de descarte de bateria. Baterias devem ser descartadas em um ponto de coletas de baterias.

21. Use este aparelho em climas tropicais e/ou moderados.

LEGAL RENUNCIANTE

O Music Tribe não se responsabiliza por perda alguma que possa ser sofrida por qualquer pessoa que dependa, seja de maneira completa ou parcial, de qualquer descrição, fotografia, ou declaração aqui contidas. Dados técnicos, aparências e outras informações estão sujeitas a modificações sem aviso prévio. Todas as marcas são propriedade de seus respectivos donos. Midas, Klark Teknik, Lab Gruppen, Lake, Tannoy, Turbosound, TC Electronic, TC Helicon, Behringer, Bugera e Coolaudio são marcas ou marcas registradas do Music Tribe Global Brands Ltd. © Music Tribe Global Brands Ltd. 2019 Todos direitos reservados.

DE

PT

GARANTIA LIMITADA

Para obter os termos de garantia aplicáveis e condições e informações adicionais a respeito da garantia limitada do Music Tribe, favor verificar detalhes na íntegra através do website musictribe.com/warranty.

JP 安全にお使いいただくために**注意**

感電の恐れがありますので、カバーやその他の部品を取り外したり、開けたりしないでください。高品質なプロ用スピーカーケーブル (¼" TS 標準ケーブルおよびツイスト ロッキング プラグケーブル) を使用してください。

**注意**

火事および感電の危険を防ぐため、本装置を水分や湿気のあるところには設置しないで下さい。装置には決して水分がかからないように注意し、花瓶など水分を含んだものは、装置の上には置かないようにしてください。

**注意**

このマークが表示されている箇所には、内部に高圧電流が生じています。手を触れると感電の恐れがあります。

**注意**

取り扱いとお手入れの方法についての重要な説明が付属の取扱説明書に記載されています。ご使用前に良くお読みください。

**注意**

1. 取扱説明書を通してご覧ください。
2. 取扱説明書を大切に保管してください。
3. 警告に従ってください。
4. 指示に従ってください。
5. 本機を水の近くで使用しないでください。
6. お手入れの際は常に乾燥した布巾を使ってください。
7. 本機は、取扱説明書の指示に従い、適切な換気を妨げない場所に設置してください。取扱説明書に従って設置してください。
8. 本機は、電気ヒーターや温風機器、ストーブ、調理台やアンプといった熱源から離して設置してください。

9. 二極式プラグおよびアースタイプ (三芯) プラグの安全ピンは取り外さないでください。二極式プラグにはピンが二本ついており、そのうち一本はもう一方よりも幅が広がっています。アースタイプの三芯プラグには二本のピンに加えてアース用のピンが一本ついています。これらの幅の広いピン、およびアースピンは、安全のためのものです。備え付けのプラグが、お使いのコンセントの形状と異なる場合は、電器技師に相談してコンセントの交換をして下さい。

10. 電源コードを踏みつけたり、挟んだりしないようご注意ください。電源コードやプラグ、コンセント及び製品との接続には十分にご注意ください。

11. すべての装置の接地 (アース) が確保されていることを確認して下さい。



12. 電源タップや電源プラグは電源遮断機として利用されている場合には、これが直ぐに操作できるように手元に設置して下さい。

13. 付属品は本機製造元が指定したもののみをお使いください。

14. カートスタンド、三脚、ブラケット、テーブルなどは、本機製造元が指定したものの、もしくは本機の付属品となるもののみをお使いください。カートを使用している際の、器具の落下による怪我に十分ご注意ください。

15. 雷雨の場合、もしくは長期間ご使用にならない場合は、電源プラグをコンセントから抜いてください。

16. 故障の際は当社指定のサービス技術者にお問い合わせください。電源コードもしくはプラグの損傷、液体の装置内への浸入、装置の上に物が落下した場合、雨や湿気に装置が晒されてしまった場合、正常に作動しない場合、もしくは装置を地面に落下させてしまった場合など、いかなる形であれ装置に損傷が加わった場合は、装置の修理・点検を受けてください。



17. 本製品に電源コードが付属されている場合、付属の電源コードは本製品以外ではご使用いたしません。電源コードは必ず本製品に付属された電源コードのみご使用ください。

18. ブックケースなどのような、閉じたスペースには設置しないでください。

19. 本機の上に点火した蝋燭などの裸火を置かないでください。

20. 電池廃棄の際には、環境へのご配慮をお願いします。電池は、かならず電池回収場所に廃棄してください。

21. 本機器は熱帯気候および / または温帯気候下でご使用ください。

法的放棄

ここに含まれる記述、写真、意見の全体または一部に依拠して、いかなる人が損害を生じさせた場合にも、Music Tribe は一切の賠償責任を負いません。技術仕様、外観およびその他の情報は予告なく変更になる場合があります。商標はすべて、それぞれの所有者に帰属します。Midas、Klark Teknik、Lab Gruppen、Lake、Tannoy、Turbosound、TC Electronic、TC Helicon、Behringer、Bugera および Coolaudio は Music Tribe Global Brands Ltd. の商標または登録商標です。© Music Tribe Global Brands Ltd. 2019 無断転用禁止。

限定保証

適用される保証条件と Music Tribe の限定保証に関する概要については、オンライン上 musictribe.com/warranty にて詳細をご確認ください。

JP

CN

CN 其他的重要信息**警告**
电击危险，
请勿打开机盖

带有此标志的终端设备具有强大的电流，存在触电危险。仅限使用带有 ¼" TS 或扭锁式插头的高品质专业扬声器线。所有的安装或调整均须由合格的专业人员进行。



此标志提醒您，产品内存在未绝缘的危险电压，有触电危险。



此标志提醒您查阅所附的重要的使用及维修说明。请阅读有关手册。

**小心**

为避免触电危险，请勿打开机顶盖（或背面挡板）。设备内没有可供用户维修使用的部件。请将维修事项交由合格的专业人员进行。

**小心**

为避免着火或触电危险，请勿将此设备置于雨淋或潮湿中。此设备也不可受液体滴溅，盛有液体的容器也不可置于其上，如花瓶等。

**小心**

维修说明仅是给合格的专业维修人员使用的。为避免触电危险，除了使用说明书提到的以外，请勿进行任何其它维修。所有维修均须由合格的专业人员进行。

1. 请阅读这些说明。
2. 请妥善保存这些说明。
3. 请注意所有的警示。
4. 请遵守所有的说明。
5. 请勿在靠近水的地方使用本产品。
6. 请用干布清洁本产品。
7. 请勿堵塞通风口。安装本产品时请遵照厂家的说明。
8. 请勿将本产品安装在热源附近，如暖气片、炉子或其它产生热量的设备（包括功放器）。
9. 请勿移除极性插头或接地插头的安全装置。接地插头是由两个插塞接点及一个接地头构成。若随货提供的插头不适合您的插座，请找电工更换一个合适的插座。
10. 妥善保护电源线，使其不被践踏或刺破，尤其注意电源插头、多用途插座及设备连接处。

11. 请只使用厂家指定的附属设备和配件。



备倾倒而受伤。

13. 遇闪电雷鸣或长期不使用本设备时，请拔出电源插头。

14. 所有维修均须由合格的维修人员进行。设备受损时需进行维修，例如电源线或电源插头受损，液体流入或异物落入设备内，设备遭雨淋或受潮，设备不能正常运作或被摔坏。

15. 本设备连接电源时一定要要有接地保护。



16. 若电源插头或器具耦合器用作断电装置，应当保证它们处于随时可方便操作状态。

17. 本产品仅适用于海拔 2000 米以下地区，本产品仅适用于非热带气候条件下。

**法律声明**

对于任何因在此说明书提到的全部或部分描述、图片或声明而造成的损失，Music Tribe 不负任何责任。技术参数和外观若有更改，恕不另行通知。所有的商标均为其各自所有者的财产。Midas, Klark Teknik, Lab Gruppen, Lake, Tannoy, Turbosound, TC Electronic, TC Helicon, Behringer, Bugera 和 Coolaudio 是 Music Tribe Global Brands Ltd. 公司的商标或注册商标。
© Music Tribe Global Brands Ltd. 2019 版权所有。

保修条款

有关音乐集团保修的适用条款及其它相关信息，请登陆 musictribe.com/warranty 网站查看完整的详细信息。

JP

CN

Precautions

Before installing, setting up or operating this equipment make sure you have read and fully understand all of this section and the 'IMPORTANT SAFETY INSTRUCTIONS' at the front of this manual.

This equipment is supplied by a mains voltage that can cause electric shock injury!

The following must be observed in order to maintain safety and electromagnetic compatibility (EMC) performance.

Safety warnings

Signal 0V is connected internally to the chassis.

To completely isolate this equipment from the AC mains, while observing full safety precautions (see 'Power' on page xiii), switch off the isolator switch (above the mains power sockets on rear of control centre) and then switch off the mains at the three mains outlets. Unplug the three mains leads from the rear of the control centre. For details of how to remove Volex locking type plug, see 'Power' below.

To avoid electrical shock do not remove covers.

General precautions

In the event of ground loop problems, disconnect the signal screen at one end of the connecting cables. Note that this can only be done when the equipment is used within a balanced system.

Do not remove, hide or deface any warnings or cautions.

Power

The system power supplies contain LETHAL VOLTAGES greatly in excess of the mains voltage and its rails can produce extremely large currents that could burn out equipment and wiring if shorted.

The internal power supplies are of the switch mode type that automatically sense the incoming mains voltage and will work where the nominal voltage is in the range 100 VAC to 240 VAC.

Each mains inlet is to be sourced from its own separate wall-mounted mains outlet socket.

Otherwise, their mains sources must be suitably distributed so as to meet local safety regulations.

A Volex locking type plug is fitted on each supplied mains cable, which plugs into a mains IEC connector on the unit. When fitted properly the Volex plug locks into place, preventing it from working loose, or being inadvertently knocked loose or pulled out. To fit a Volex plug, insert it into the mains IEC connector and push it in until it locks in place. Then, check to make sure it is locked in place. To remove it, release its locking device and then pull it out. When fitting or removing a Volex plug, always hold the plug itself and never use the cable, as this may damage it.

During operation, a minimum of two of its three mains inlets must be connected and supplying power.

When removing the equipment's electric plugs from the outlets, always hold the plug itself and not the cable. Pulling out the plug by the cable can damage it.

Never insert or remove an electric plug with wet hands.

Do not connect/disconnect a mains power connector to/from the M32 Control Centre while power is being applied to it. Switch the power off first.

Before switching the M32 Control Centre on or off, make sure that all monitor loudspeaker power amplifiers are turned off or muted.

Handling the equipment

Completely isolate the equipment electrically and disconnect all cables from the equipment before moving it.

When lifting or moving the equipment, always take its size and weight into consideration. Use suitable lifting equipment or transporting gear, or sufficient additional personnel.

Do not insert your fingers or hands in any gaps or openings on the equipment, for example, vents.

Do not press or rub on the sensitive surface of the GUI screens.

If the glass of the GUI screen is broken, liquid crystals shouldn't leak through the break due to the surface tension of the thin layer and the type of construction of the LCD panel. However, in the unlikely event that you do make contact with this substance, wash it out with soap.

Installation

Before installing the equipment:

Make sure the equipment is correctly connected to the protective earth conductor of the mains voltage supply of the system installation through the mains leads

Power to the equipment must be via a fused spur(s)

Power plugs must be inserted in socket outlets provided with protective earth contacts. The electrical supply at the socket outlets must provide appropriate over-current protection

Both the mains supply and the quality of earthing must be adequate for the equipment

Before connecting up the equipment, check that the mains power supply voltage rating corresponds with the local mains power supply. The rating of the mains power supply voltage is printed on the equipment.

Location

Ideally a cool area is preferred, away from power distribution equipment or other potential sources of interference.

Do not install the equipment in places of poor ventilation.

Do not install this equipment in a location subjected to excessive heat, dust or mechanical vibration. Allow for adequate ventilation around the equipment, making sure that its fans and vents are not obstructed. Whenever possible, keep the equipment out of direct sunlight.

Do not place the equipment in an unstable condition where it might accidentally fall over.

Make sure that the mains voltage and fuse rating information of the equipment will be visible after installation.

Ensure that all underside vents are left clear during operation.

Audio connections

To ensure the correct and reliable operation of your equipment, only high quality, balanced, screened, twisted pair audio cable should be used.

XLR connector shells should be of metal construction so that they provide a screen when connected to the control centre and, where appropriate, they should have Pin 1 connected to the cable screen.



Electrostatic discharge (ESD) precautions

Observe full electrostatic discharge

(ESD) — also known as ‘anti-static’ — precautions when carrying out procedures in this manual that are accompanied by the ESD Susceptibility Symbol (shown above). This caution symbol shows you that ESD damage may be caused to items unless proper ESD precautions are taken, which include the following practices:

- Keep the work area free from plastic, vinyl or styrofoam
- Wear an anti-static wrist strap
- Discharge personal static before handling devices
- Ground the work surface
- Avoid touching ESD-sensitive devices.

Radio frequency interference—Class A device

This equipment has been tested and found to comply with the limits for a Class A digital device, pursuant to Part 15 of the FCC Rules.

These limits are designed to provide reasonable protection against harmful interference when the equipment is operated in a commercial environment. This equipment generates, uses, and can radiate radio frequency energy and, if not installed and used in accordance with the instruction manual, may cause harmful interference to radio communications.

Operation of this equipment in a residential area is likely to cause harmful interference in which case the user will be required to correct the interference at his own expense.

Electric fields

Caution:

In accordance with Part 15 of the FCC Rules & Regulations, “... changes or modifications not expressly approved by the party responsible for compliance could void the user’s authority to operate the equipment.”

Should this product be used in an electromagnetic field that is amplitude modulated by an audio frequency signal (20 Hz to 20 kHz), the signal to noise ratio may be degraded. Degradation of up to 60 dB at a frequency corresponding to the modulation signal may be experienced under extreme conditions (3 V/m, 90% modulation).

Safety equipment

Never remove, for example, covers, housings or any other safety guards. Do not operate the equipment or any of its parts if safety guards are ineffective or their effectiveness has been reduced.

Optional equipment

Unless advised otherwise, optional equipment must only be installed by service personnel and in accordance with the appropriate assembly and usage regulations.

Special accessories

To comply with part 15 of the FCC Rules, any special accessories (that is, items that cannot be readily obtained from multiple retail outlets) supplied with this equipment must be used with this equipment; do not use any alternatives as they may not fulfil the RF requirement.

Introduction

Welcome to the M32R Digital Console User manual! After years of intense development, we are proud to offer a mixer that combines tremendous power and flexibility with a very user-friendly layout and intuitive workflow that allows you to get up and running right away.

The M32R combines a control surface with streamlined workflow, extensive I/O and signal processing into a compact desktop form factor. Employing award-winning Midas PRO Series microphone preamplifiers and the custom-designed Midas PRO motorised faders that are rated for one million cycles, along with a daylight-viewable TFT screen, the control surface is designed to allow immediate access to critical functions with total and automatic recall of settings. Extensive onboard I/O includes 40 A/D and 24 D/A Cirrus Logic converters, 96 bi-directional channels over SuperMAC AES50, stereo AES/EBU out, 16 channels of ULTRANET personal monitoring and 32 x 32 channels of recording over USB.

Abundant analogue connectivity is provided by 16 Midas PRO Series digitally-controllable microphone preamps, six line-level auxiliary inputs and outputs, eight XLR outputs, stereo monitoring outs on XLR/TRS and dual phones outputs. Each of the 16 microphone inputs can accept balanced or unbalanced mic- or line-level signals, and include switchable phantom power, 72 dB gain range and maximum +23 dBu level before clip. A separate external microphone input and the internal talkback mic allow communication to various destinations.

Dual AES50 Ethernet jacks that employ Klark Teknik SuperMAC technology contribute 96 x 96 signals to the total count of 168 x 168 accessible sources and destinations. Motorised faders, recallable mic preamps, programmable routing and the ability to save and recall entire scenes make set or programme changes quick and simple. A top panel USB connector enables system data to be stored, or a board mix to be recorded directly to external flash or hard drives.

The Input section is home to eight high-resolution 100 mm motorised faders, providing control over channels 1-32, Aux inputs/USB playback/FX returns. A separate section of eight motorised faders controls DCA groups 1-8, bus masters 1-8 and 9-16, as well as matrices 1-6. The channel editing section provides tangible controls for instant access to the selected channel’s gain, dynamics, EQ and other functions.

A main five inch-wide, high-contrast colour display provides information for editing pertinent parameters of the active function or effect. Relevant parameters are quickly recalled to the display for editing via ‘VIEW’ buttons in each subsection. Each channel also features a small, customisable LCD screen for track name, number, colour and source graphic.

A virtual FX rack offers eight true-stereo (16 mono) multi-effects processors, with over 60 effects models that eliminate the need for any additional outboard gear. Four high-quality effects such as delay, chorus and reverb can run concurrently with eight channels of 31-band graphic equalisation.

Transmit up to 32 channels of audio to and from a computer using the Klark Teknik DN32 USB audio interface.

The M32R integrates seamlessly with other M32 consoles, the Midas DL16 digital stagebox and the Behringer P-16 personal monitoring system for a complete live, studio and installed sound solution.

Control the mixer from a distance with the free application for iPad* or with editing and remote control software connected via Ethernet. The M32R’s ease of use, intuitive workflow, diverse feature set and integration with other equipment make it an ideal centrepiece for installed and production sound in any setting.

Continue through this User Manual to learn all about the functionality that this powerful mixer has to offer. We also recommend that you check midasconsoles.com to make sure you have the latest firmware installed, as we release frequent updates.

*iPad is a trademark of Apple Inc.

1. Control Surface

1.1 Channel Strip - Input Channels

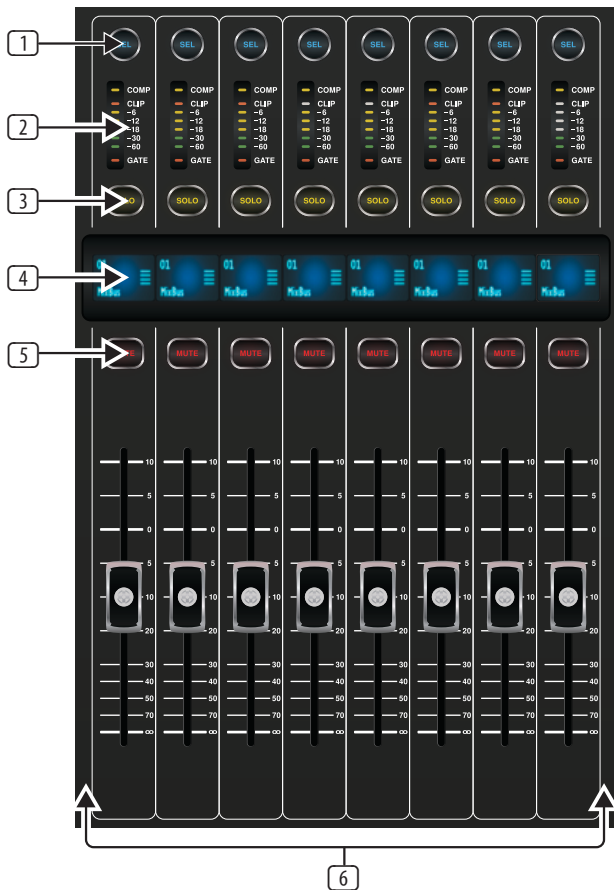

1 SEL Button

Press to select an input or bus (depending on which layer is active) and allow it to be edited by the Channel Strip and Main Display.

2 Channel Meter

This displays the signal level of the input or bus, depending on which layer is active. The COMP and GATE LEDs light to indicate that compression and/or noise gate are active.

3 SOLO Button

Press to send the channel to the solo bus.

4 Scribble Strip

Information such as channel number, input source and a graphic icon are displayed here.

5 MUTE Button

Press to mute the channel.

6 Fader

Use the Midas PRO Motor Fader to adjust the channel output volume. In **Sends on Faders** mode channel faders represent the send level from channels to the currently selected output bus (see next page).

1.2 Channel Strip - Group/Bus Channels

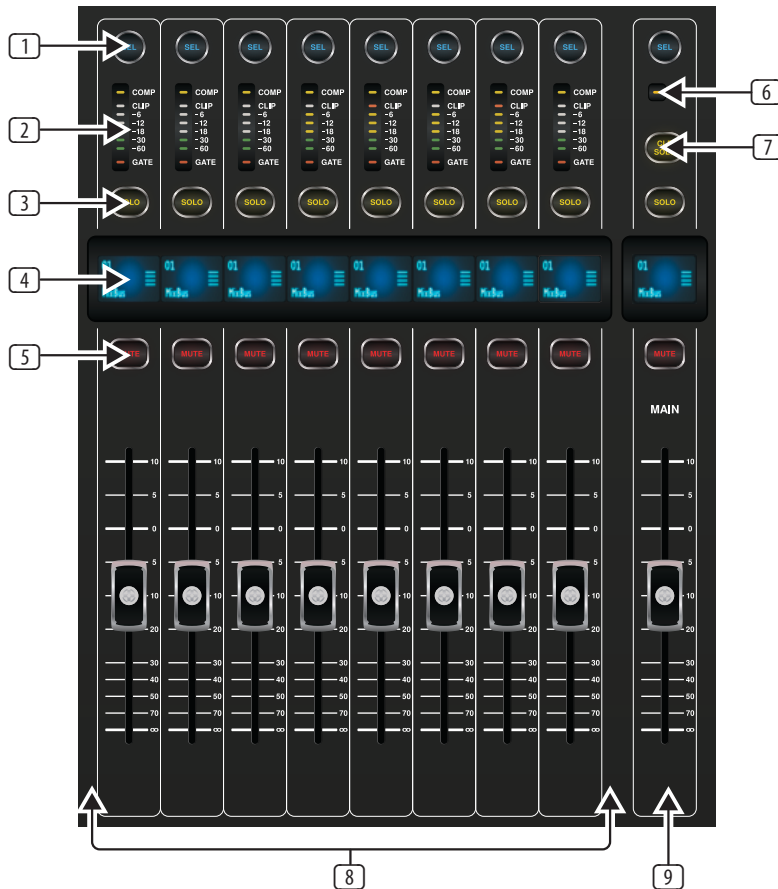

1 SEL Button

Press to select a DCA or bus (depending on which layer is active) and allow it to be edited by the Channel Strip and Main Display.

2 Channel Meter

This displays the signal level of the DCA or bus, depending on which layer is active. The PRE LED lights to indicate that the bus is sourced pre-fader, while the COMP LED lights to indicate that compression is active.

3 SOLO Button

Press to send the channel to the solo bus.

4 Scribble Strip

Information such as channel number, input source and a graphic icon are displayed here.

5 MUTE Button

Press to mute the channel.

6 COMP

The COMP indicator will illuminate when compression is being applied to the stereo output mix.

7 CLR SOLO Button

Press to clear all sources assigned to the solo bus.

8 Bus Faders

Use the Midas PRO Fader to adjust the channel volume or bus sends in **Sends on Faders** mode. The faders will automatically display the current status as layers and functions are changed.

9 Fader

Use the Midas PRO Fader to adjust the output of the main bus.

1.3 Config/Preamp

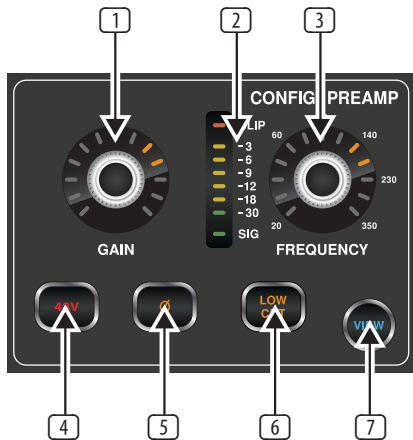

1 GAIN Rotary Control

On a microphone preamplifier, input gain varies the amount of amplification applied to the microphone. Adjust the preamp gain for the selected channel with the **GAIN** rotary control.

2 LED Display

The LED display in the Config/Preamp section illustrates the signal input level for the selected channel. This is shown as a value between 0 dB and -30 dB. When there is a signal present, but below -30 dB, the SIG LED is lit. When the signal exceeds 0 dB the CLIP LED illuminates.

Please note that, when pressing the **VIEW** button, the signal input level displayed on the Main Display shows a value of between 0 dB and -60 dB.

3 FREQUENCY Rotary Control

The **FREQUENCY** rotary control selects the frequency at which the low cut filter begins to filter unwanted frequencies for the selected channel. The filter is engaged by pressing the **LOW CUT** button (see below).

Please note that the low cut filter is only available for the 32 primary input channels.

4 48 V

Phantom power is a method for transmitting DC electric power through microphone cables to operate microphones that contain active electronic circuitry. It is most commonly used with condenser microphones, though many active direct boxes also use it. The technique is also used in other applications where power supply and signal communication take place over the same wires. Press the **48 V** button to apply phantom power on the selected channel's physical input.

5 Ø

An audio signal's 'phase' refers to its position in a point of time along the waveform cycle, with each cycle being 360°. Press the **Ø** button to reverse the selected channel's phase by 180°. This can be useful when using the reverse phase function to cancel noise across more than one channel.

6 LOW CUT

Press the **LOW CUT** button to engage the low cut filter for the selected channel.

Please note that the low cut filter is only available for the 32 primary input channels.

7 VIEW

Press the **VIEW** button to access more detailed parameters on the Main Display. See the section **Main Display - config** for more details.

1.4 Gate



1 THRESHOLD Rotary Control

A noise gate is a device that is used to control the volume of an audio signal. Often used in conjunction with a compressor (see DYNAMICS), which attenuate signals above a certain threshold, noise gates attenuate signals that register below the threshold. By turning the **THRESHOLD** rotary control, the audio level at which the gate affects the signal can be controlled.

2 LED Display

The LED display illustrates when the Gate is functioning for the selected channel by illuminating the red **GATE** LED at the bottom of the display.

3 GATE

Pressing the **GATE** button engages the noise gate for the selected channel.

4 VIEW

Press the **VIEW** button to access more detailed parameters on the **Main Display**. See the section **Main Display - gate** for more details.

1.5 Dynamics

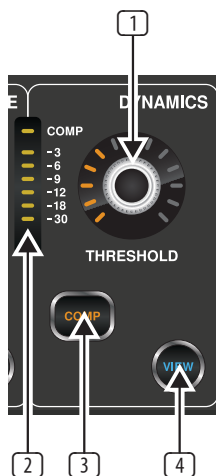

1 THRESHOLD Rotary Control

Dynamic Range Compression, or just Compression is a device that is used to control the volume of an audio signal. Often used in conjunction with a noise gate (see GATE), which attenuate signals below a certain threshold, compressors attenuate signals that register above the threshold. By turning the **THRESHOLD** rotary control, the audio level at which the compressor affects the signal can be controlled.

2 LED Display

The LED display illustrates when the Dynamics are functioning for the selected channel by illuminating the red **COMP** LED. The level of attenuation that is being applied to the signal is shown as a value between 0 dB and -30 dB.

Please note that, when pressing the **VIEW** button, the attenuation level displayed on the Main Display shows a value of between 0 dB and -60 dB.

3 COMP

Pressing the **COMP** button engages the compressor for the selected channel.

4 VIEW

Press the **VIEW** button to access more detailed parameters on the **Main Display**. See the section Main Display - dyn for more details.

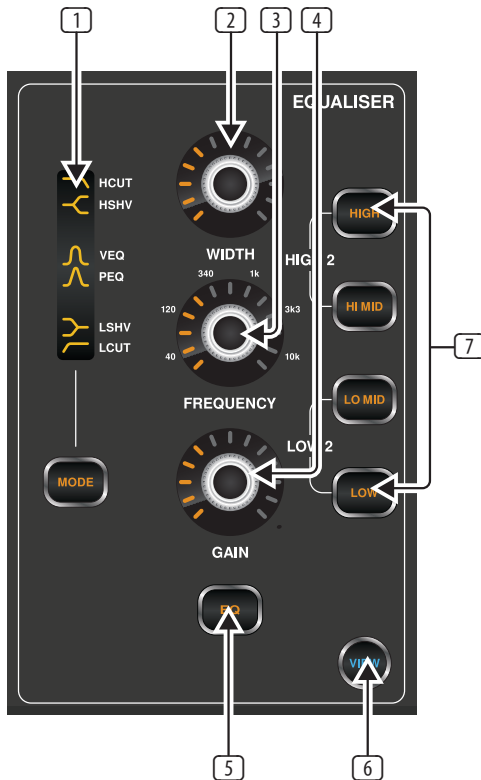
1.6 Equaliser**1 MODE Select Button and Display**

Pressing the **MODE** button cycles through each of the EQ modes for the currently selected frequency range. Each of the modes and the frequency ranges to which they apply are listed below:

HCUT

A high-cut function which attenuates signals above the selected frequency.

HSHV

A high-shelving function which boosts or attenuates signals above the selected frequency. Only available with the **HIGH 2 - HIGH** setting.

VEQ

A bell filter that provides a more 'Vintage EQ' sound. Available on all frequency settings.

PEQ

A bell filter that provides a classic 'Parametric EQ' sound. Available on all frequency settings.

LSHV

A low-shelving function which boosts or attenuates signals below the selected frequency. Only available with the **LOW 2 - LOW** setting.

LCUT

A low-cut function which attenuates signals below the selected frequency.

NOTE: Low-Cut and High-Cut Modes do not have Gain and Width settings.

2 WIDTH Rotary Control

The **WIDTH** rotary control determines the span of frequencies around that specified by the **FREQUENCY** rotary control, which will be affected by adjusting the **GAIN** control.

3 FREQUENCY Rotary Control

Select the specific frequency to be adjusted with the **FREQUENCY** rotary control. Each frequency can be adjusted between 20 Hz and 20 kHz. The equaliser provides four discrete filter bands for input channels and even six discrete bands for buses and matrices as follows:

7 - Individual Band Frequencies**HIGH**

A band intended for high frequencies, with access to **HCUT**, **HSHV**, **VEQ** and **PEQ** EQ modes.

HI MID

A band intended for high-mid frequencies, with access to **VEQ** and **PEQ** EQ modes.

LO MID

A band intended for low-mid frequencies, with access to **VEQ** and **PEQ** EQ modes.

LOW

A band intended for low frequencies, with access to **LCUT**, **LSHV**, **VEQ** and **PEQ** EQ modes.

HIGH 2

Press **HIGH** and **HI MID** concurrently to access the **HIGH 2** band of any bus equaliser.

LOW 2

Press **LOW** and **LO MID** concurrently to access the **LOW 2** band of any bus equaliser.

4 GAIN Rotary Control

Boost or attenuate the selected frequency by turning the **GAIN** rotary control. The selected equaliser band is inactive when the Gain control is in the centre position (0 dB).

5 EQ Button

Engages the EQ function for the selected channel.

6 VIEW

Press the **VIEW** button to access more detailed parameters on the **Main Display**. See the section Main Display - eq for more details.

1.7 Main Bus



1 LEVEL Rotary

Adjust the overall send level to the Mono Bus with the **LEVEL** rotary control.

2 PAN/BAL Rotary

When the selected channel is assigned to the Stereo Bus, the **PAN/BAL** rotary control adjusts the left to right positioning of the audio signal.

3 MONO

Press the **MONO** button to assign the selected channel to the Main Mono/ Centre Bus.

4 ST

Press the **ST** select button to assign the selected channel to the Main Stereo Bus.

5 VIEW

Press the **VIEW** button to access more detailed parameters on the Main Display. See the section **Main Display - main** for more details.

1.8 Recorder

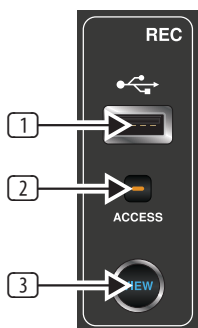

1 USB Port

Connect a USB stick to install firmware updates and to record performances.

2 ACCESS

The **ACCESS** LED illuminates to indicate that a USB stick is in place and is being written to or read from.

3 VIEW

Press the **VIEW** button to open the USB Recorder pages on the Main Display.

1.8.1 Operation

The M32R offers functionality for playing back uncompressed stereo WAV files, and for recording any stereo signal in the console directly onto USB stick or compatible USB hard drive. Note - multi-channel recording is only available via the DN32-USB card.

To record to a USB stick, perform the following steps:

1. Plug a FAT-formatted (FAT12, FAT16, FAT32) USB stick into the USB port as illustrated above.
2. Press the **VIEW** button in the **RECORDER** panel. This will then display a graphic representation of an analogue tape deck on the Main Display **home** tab.



3. On the **config** tab you can select the source of the recording, the default being the main L & R outputs.
4. Press the fifth push encoder, labelled **Record**.
5. To adjust the volume during playback, press the **AUX IN/USB** button next to the input channel faders, and adjust the volume using AUX faders 7 & 8.

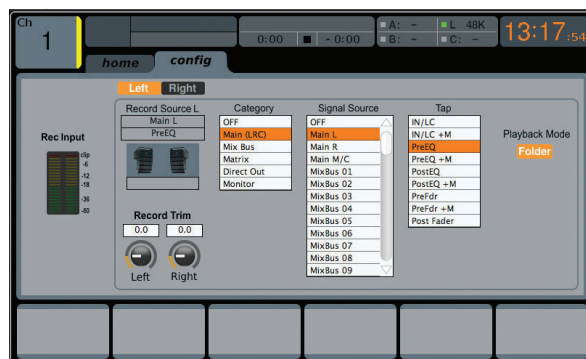

1.8.2 Firmware Updates

The M32R firmware can easily be updated by performing the following steps:

- Download the new console firmware from the M32R product page onto the root level of a USB thumb drive
- Plug the USB thumb drive into the front panel USB connector while the console is turned off
- Hold the USB View button depressed while switching the console on. While booting, the M32R will run a fully automatic firmware update, which will take 2-3 minutes longer than the regular boot sequence

When no update file is available on the USB drive, or when it is corrupted, the update mode will remain active, preventing the M32R from booting regularly. Switch the console off and back on without holding the USB View button to boot the console with the existing firmware.

The USB socket is not suitable for other non-memory USB devices like keyboards, mice, lamps, etc.

1.9 Main Display (Summary)

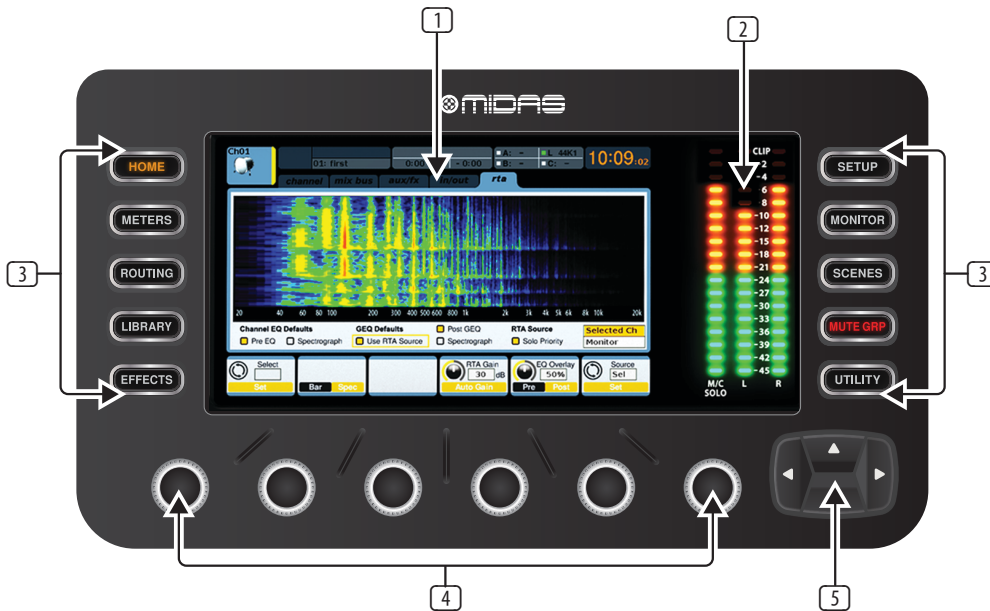

1 DISPLAY SCREEN

The controls in this section are used in conjunction with the colour screen in order to navigate and control the graphical elements it contains.

By including dedicated push encoders that correspond to the adjacent controls on the screen, as well as including cursor buttons, the user can quickly navigate and control all of the colour screen's elements.

The colour screen contains various displays that give visual feedback for the operation of the console, and also allow the user to make various adjustments not provided for by the dedicated hardware controls.

2 MAIN/SOLO METERS

This triple 24-segment meter displays the audio signal level output from the main bus, as well as the main centre or solo bus of the console.

3 SCREEN SELECTION BUTTONS

These 10 illuminated buttons allow the user to immediately navigate to any of the eight master screens that address different sections of the console, plus the Mute Group and Utility functions. The sections that can be navigated are:

HOME

The **HOME** screen contains an overview of the selected input or output channel, and offers various adjustments not available through the dedicated top-panel controls.

The **HOME** screen contains the following separate tabs:

home: General signal path for the selected input or output channel.

config: Allows selection of the signal source/destination for the channel, configuration of insert point, and other settings.

gate: Controls and displays the channel gate effect beyond those offered by the dedicated top-panel controls.

dyn: Dynamics - controls and displays the channel dynamics effect (compressor) beyond those offered by the dedicated top-panel controls.

eq: Controls and displays the channel EQ effect beyond those offered by the dedicated top-panel controls.

sends: Controls and displays for channel sends, such as sends metering and send muting.

main: Controls and displays for the selected channel's output.

METERS

The **METERS** screen displays different groups of level meters for various signal paths, and is useful for quickly ascertaining if any channels need level adjustment. Since there are no parameters to adjust for the metering displays, none of the metering screens contain any 'bottom of the screen' controls that would normally be adjusted by the six push encoders.

The **METERS** screen contains the following separate screen tabs, each containing level meters for the relevant signal paths: **channel**, **mix bus**, **aux/tx**, **in/out** and **rta**.

ROUTING

The **ROUTING** screen is where all signal patching is done, allowing the user to route internal signal paths to and from the physical input/output connectors located on the console's rear panel.

The **ROUTING** screen contains the following separate tabs:

home: Allows patching of physical inputs to the 32 input channels and aux inputs of the console.

out 1-16: Allows patching of internal signal paths to the console's 8 rear panel XLR outputs.

aux out: Allows patching of internal signal paths to the console's six rear panel 1/4" / RCA auxiliary outputs.

p16 out: Allows patching of internal signal paths to the 16 outputs of the console's 16-channel P16 ULTRANET output.

card out: Allows patching of internal signal paths to the 32 outputs of the expansion card.

aes50-a: Allows patching of internal signal paths to the 48 outputs of the rear panel AES50-A output.

aes50-b: Allows patching of internal signal paths to the 48 outputs of the rear panel AES50-B output.

xlr out: Allows the user to configure the XLR outs on the rear of the console in blocks of four, from either local inputs, the AES streams, or expansion card.

LIBRARY

The **LIBRARY** screen allows loading and saving of commonly-used setups for the channel inputs, effects processors, and routing scenarios.

The **LIBRARY** screen contains the following tabs:

channel: This tab allows the user to load and save commonly used combinations of the channel processing, including dynamics and EQ.

effects: This tab allows the user to load and save commonly used effects processor presets.

routing: This tab allows the user to load and save commonly used signal routings.

EFFECTS

The **EFFECTS** screen controls various aspects of the eight effects processors. On this screen the user can select specific types of effects for the eight internal effects processors, configure their input and output paths, monitor their levels, and adjust the various effects parameters.

The **EFFECTS** screen contains the following separate tabs:

home: The home screen provides a general overview of the virtual effects rack, displaying what effect has been inserted in each of the eight slots, as well as displaying input/output paths for each slot and the I/O signal levels.

fx1-8: These eight duplicate screens display all of the relevant data for the eight separate effects processors, allowing the user to adjust all parameters for the selected effect.

SETUP

The **SETUP** screen offers controls for global, high-level functions of the console, such as display adjustments, sample rates & synchronisation, user settings, and network configuration.

The **SETUP** screen contains the following separate tabs:

global: This screen offers adjustments for various global preferences of how the console operates.

config: This screen offers adjustments for sample rates and synchronisation, as well as configuring high-level settings for signal path buses.

remote: This screen offers different controls for setting up the console as a control surface for various DAW recording software on a connected computer. It also configures the MIDI Rx/Tx preferences.

network: This screen offers different controls for attaching the console to a standard Ethernet network. (IP address, Subnet Mask, Gateway.)

scribble strip: This screen offers controls for various customisation of the console's LCD scribble strips.

preamps: Shows the analogue gain for local mic inputs (XLR at the rear) and phantom power, including setup from remote stage boxes (e.g. DL16) connected via AES50.

card: This screen selects the input/output configuration of the installed interface card.

MONITOR

Pressing the **MONITOR** button has the same effect as pressing the **VIEW** button in the **MONITOR** panel, and is covered in detail in the **MONITOR** section below.

SCENES

Pressing the **SCENES** button accesses the M32R's automation functions. This screen is covered in detail in the **SCENES** section of the **MAIN DISPLAY** chapter.

MUTE GRP

The **MUTE GRP** screen allows for quick control of the console's six mute groups.

UTILITY

The **UTILITY** screen is a supplemental screen designed to work in conjunction with the other screens that may be in view at any particular moment. The **UTILITY** screen is never seen by itself, it always exists in the context of another screen, and typically brings up copy, paste and library or customisation functions. For example:

- When you are adjusting the EQ of a channel, pressing the **UTILITY** button will offer copying, pasting or loading functionality, or saving of EQ settings
- Pressing the **UTILITY** button while editing a channel's **CONFIG/PREAMP** screen will offer copying, saving or loading preamp configurations

NOTE: Pressing the **UTILITY** button while holding the channel Select button is a shortcut to editing the channel's scribble strip display icon, naming or colour.

- On the **ROUTING** screen, pressing **UTILITY** will offer the ability to load or save different presets of routing scenarios
- On the **CUES, SCENES, SNIPPETS, PARAM SAFE** and **CHAN SAFE** pages, pressing **UTILITY** also offers different levels of import/export functions:

Cues: Utility allows importing or exporting complete Show data, including all Cues, Scenes, Snippets and Safes to attached USB media.

Scenes: Utility offers selecting a number of scenes for exporting or importing on attached USB media.

Snippets: Utility offers selecting a number of snippets for exporting or importing on attached USB media.

Param Safes/Chan Safes: Utility allows setting/resetting the Safe flags for a complete column of entries at once.

4 PUSH ENCODERS

These six push encoders are used to adjust the various elements located directly above them. Each of the six encoders can be pushed inward to activate a button-press function. This function is useful when controlling elements that have a dual on/off status that is best controlled by a button, as opposed to a variable state that is best adjusted by a rotary control.

5 UP/DOWN/LEFT/RIGHT NAVIGATION CONTROLS

The **LEFT** and **RIGHT** controls allow for left-right navigation among the different pages contained within a screen set. A graphical tab display shows which page you are currently on. On some screens there are more parameters present than can be adjusted by the six push encoders underneath. In these cases, use the **UP** and **DOWN** buttons to navigate through any additional layers contained on the screen page. The **LEFT** and **RIGHT** buttons are sometimes used to confirm or cancel confirmation pop-ups.

Please refer to the **MAIN DISPLAY** chapter for more information on these topics.

1.10 Monitor

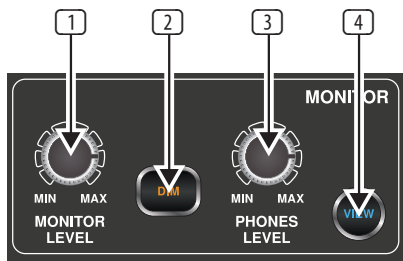

1 MONITOR LEVEL Rotary Control

Adjust the level of the monitor outputs with the **MONITOR LEVEL** rotary control. This will be the output device connected to the sockets in the **MONITOR / CONTROL ROOM OUT** section on the rear panel.

2 PHONES LEVEL Rotary Control

Adjust the level of the signal through the headphones or other output devices connected via the headphone jack sockets located under the front of the console.

3 MONO

Press the **MONO** button to monitor the audio signal in mono.

4 DIM

Press the **DIM** button to reduce the monitor volume by a predefined amount. The amount of attenuation can be defined via the Main Display when the **VIEW** button is pressed.

5 VIEW

Press the **VIEW** button to access more detailed parameters on the Main Display.

1.10.1 Operation

The **MONITOR** section shares a Main Display screen with the **TALKBACK** section. On this screen, only the **monitor** tab contains functionality which relates to the **MONITOR** section. This tab controls various console options relating to the solo bus, as well as the console's control room outputs. These options include various solo settings, speaker dimming, speaker delay, and a selection of sources for the control room output.

To adjust the settings on the **monitor** tab, perform the following steps:

- Adjust the first push encoder to change the gain of the monitor signal. This digital stage occurs as a first preliminary level control, before the top panel's analogue-based monitor level control. A display above the push encoder shows the currently set gain value in dB.
 - A multi-segment level meter is displayed on the Main Display to allow for proper gain staging of the monitor signal.
- Adjust the second push encoder to scroll through the various solo methods available to the console when audio is routed to the solo bus. Available options include:
 - Exclusive (last):** In this mode, pressing another **SOLO** button disengages the previous solo
 - Solo Follows Select:** When this method is selected, the audio of the currently selected channel will automatically be sent to the solo bus. Since a user will often select a channel to adjust its dedicated DSP controls, this method is useful because the audio of the channel will now already be feeding the solo bus where it can be monitored with headphones in a live sound environment
 - Select Follows Solo:** When this method is selected, any channel that is soloed will automatically become the currently selected channel

- Ch Solo AFL:** The channel and select button do not have any correlation to each other. When a channel's **SOLO** button is pressed, its audio is sent to the solo bus in 'after-fader-listen' mode, reflecting the current level of the channel fader and any channel DSP that has been applied. The default setting for input channels is off for 'pre-fader-listen'.



- MixBus Solo AFL:** Selecting this method will set the mix bus solo to post-fader
- DCA Solo AFL:** Selecting this method will set the DCA solo to post-fader
- Use DIM for PFL:** Selecting this option will apply **DIM** to all PFL signals
- Use Master Fader:** This allows the main fader/**MUTE** button to control the solo/mon output.

- Tap the second encoder to select and assign the currently chosen solo option.
- Turn the third encoder to adjust the amount of digital delay that is applied to the control room signal path. The display on the screen will show the current amount of delay in feet, metres and milliseconds.
- Tap the third encoder to toggle the delay function on or off.

TIP: The delay function is useful for aligning the sound of audio monitored through headphones, or speakers used at front-of-house position with audio that is coming from the stage location.

By delaying the control room audio, it can be brought into alignment with the slightly-delayed audio that has to travel from the stage to the front-of-house position.

- Adjust the fourth encoder to set the amount of volume reduction that occurs when the control room bus has its **DIM** function enabled. The amount of volume reduction ranges from -40 dB to 0 dB (no change).
- Tap the fourth encoder to toggle the **DIM** function on or off.
- Turn the fifth encoder to adjust the volume trim for the source currently feeding the control room bus, allowing it to be level matched with the **SOLO** bus. The amount of trim can be adjusted from -20 dB to +20 dB.
- Tap the fifth encoder to toggle the control room between mono and stereo operation. This is very useful in a studio context for checking how a mix sounds when played back on a mono speaker such as a cock radio.
- Adjust the sixth encoder to select what specific signal source to monitor in the control room. Choices include:
 - Off (no source) in the control room, when no **SOLO** is active
 - LR Bus
 - LR + C/M
 - LR PFL (Pre-Fade Listen)
 - LR AFL (After-Fade Listen)
 - Auxiliary returns 5/6
 - Auxiliary returns 7/8 (USB Recorder).
- Tap the sixth encoder to activate the signal source that has been chosen.

1.11 Talkback

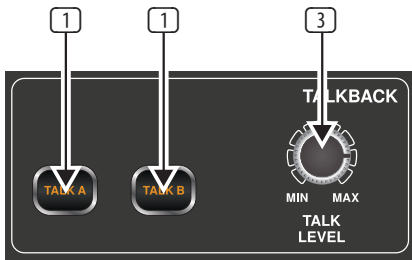

① & ② - TALK A / B

Select the destination of the Talkback mic signal with either the **TALK A** or **TALK B** buttons. Press the **VIEW** button in the **MONITOR** section to edit the Talkback routing for A and B.

③ TALK LEVEL Rotary Control

Adjust the level of the Talkback volume with the **TALK LEVEL** rotary control.

1.11.1 Operation

talkback Tab

The **TALKBACK** screen offers various adjustments for the talkback paths of the console, such as destination of the talkback signal and more.

To adjust the various settings on the **talkback** tab, perform the following steps:

1. The screen displays a multi-segment level meter showing the strength of the talkback signal as it has currently been set. It also displays a multi-segment gain reduction meter, showing the user how much compression has been automatically applied to the talkback signal.
2. Tap the first push encoder to enable the talkback circuit. The internal/external talkback microphone will now transmit audio to the **talkback** path's assigned destination.
3. Adjust the third encoder to set the gain of the **talkback** signal. This is an additional gain stage that follows the initial gain stage set by the top panel **TALK LEVEL** control.
4. Tap the third encoder to toggle on/off the talkback circuits 'auto-dim' function. This function is useful in a studio setting, and will automatically dim the control room outputs when the talkback circuit is active. This prevents the talkback microphone from picking up too much sound from the nearby studio monitors.

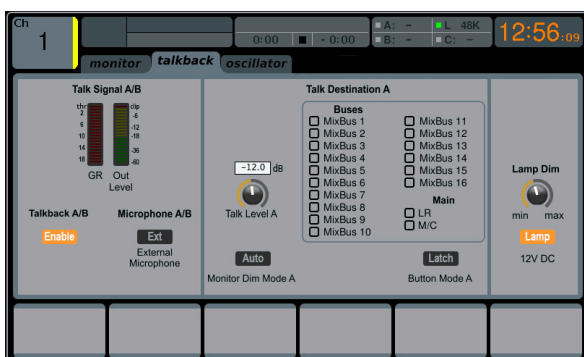

5. Adjust the fourth encoder to scroll through the various talkback destinations, which include:
 - Mix Bus 1-16
 - LR Bus
 - Centre/Mono Bus.

6. Tap the fourth encoder to activate any talkback destination when it is currently selected. Multiple talkback destinations can be selected, allowing the talkback signal to reach many destinations at the same time.
7. Tap the fifth encoder to toggle the dedicated top-panel talkback buttons between latching and non-latching operation.

oscillator Tab

The **oscillator** tab offers controls for the console's onboard oscillator, a very handy tool that can be used for setting up PA systems and testing various signal flow paths without the need for a live source feeding a microphone. Settings include oscillator type, frequency, volume and routing destinations.

To adjust the various settings on the oscillator tab, perform the following steps:

1. Adjust the first push encoder to set the level of the onboard oscillator.
2. Tap the first encoder to toggle the oscillator on or off.
 - The Main Display shows a multi-segment level meter that shows the current level of the oscillator.
3. Adjust the second encoder to set the frequency of the primary onboard oscillator.
4. Adjust the third encoder to set the frequency of the alternate onboard oscillator.
5. Tap the third encoder to alternate between Sine F1 and Sine F2.
6. Adjust the fourth encoder to select the type of oscillator to be used. Choices include:
 - Sine Wave
 - Pink Noise
 - White Noise.
7. Tap the fourth encoder to engage the selected oscillator type.
8. Adjust the sixth encoder to select a destination for the onboard oscillator. Choices include:
 - Mix Bus 1-16
 - Main L Bus
 - Main R Bus
 - Main L+R Bus
 - Main Centre / Mono
 - Matrix Outputs 1-6.
9. Tap the sixth encoder to assign the selected oscillator destination.

1.12 Assign



1.12.1 Buttons 1-8

Assign the eight buttons to various parameters for instant access to commonly used functions. Details can be found on the Main Display by pressing the **VIEW** button (see below).

1.12.2 VIEW

This gives you more detailed access to the **ASSIGN** functions via the Main Display. The **ASSIGN** screen allows setup for the four user-assignable rotary controls and the eight user-assignable buttons. Using this screen the console operator can assign three sets of 12 custom controls to be available for adjustment at all times.

Note: The M32R only has 8 Assign buttons, and no rotary controls. However, the software still supports custom-assignable rotary control.

The **ASSIGN** screen contains the following separate tabs:

home: This screen provides a general overview of the 12 assigned controls for all three control sets at the same time.

set A: This screen allows assignment of different console parameters to the 12 custom controls for Set A.

set B: Works as described above, but for custom controls Set B

set C: Works as described above, but for custom controls Set C

HOME



The **ASSIGN** screen's **home** tab provides a visual overview of the 12 assigned controls for all three sets at the same time.

The **home** tab offers visual feedback of the controls that have been assigned to all three sets of custom controls, without having to bank between the three sets one-by-one, or relying on abbreviated syntax shown in the custom control's dedicated LCD displays.

To adjust the various settings on the **home** tab, perform the following steps:

1. Turn any of the push encoders 1-5 to move screen focus to different custom-assignable rotary controls and buttons in the A, B and C sets. The controls currently selected with each of the four rotary controls are highlighted with an orange outline.
2. Tap any of the push encoders 1-5 to switch to the edit screen for the specific custom control that was highlighted on the **home** tab screen.

SET A, B & C

The **set A, B & C** tabs allow mapping of specific console parameters to the eight assignable buttons and four assignable rotary controls. Using these screens the user can map the exact parameters that are most useful to them to the desired controls, in the desired order.

To adjust the various settings on the **set A, B & C** tabs, perform the following steps:

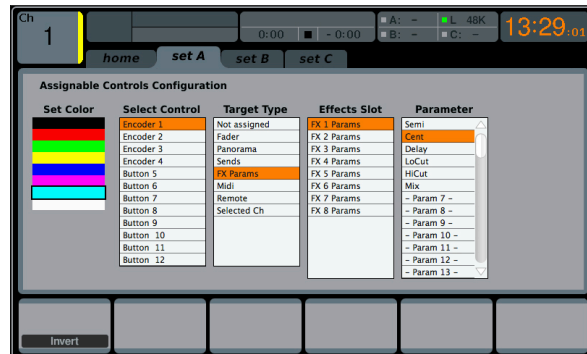

1. Adjust the first push encoder to select the colour used for the LCD screens within that set. This is not applicable for the M32R since there are no LCD screens in the Assign section.
2. Adjust the second push encoder to select to which of the 12 assignable controls in the appropriate set you wish to map a parameter.
3. Adjust the third push encoder to scroll through a list of parameter categories to which the selected assignable control can be mapped. Choices for the buttons include:
 - Not Assigned
 - Jump to Page
 - Mute Channel
 - Inserts
 - Effect Button
 - MIDI
 - Remote.
 Choices for the rotary controls include:
 - Not Assigned
 - Panorama
 - Sends
 - Dynamics
 - FX Parameters
 - MIDI
 - Remote.
4. Tap the third push encoder to select the desired type of parameter.
5. Where applicable, tap/select the fourth, fifth and sixth push encoders to assign the specific parameter.

1.13 Fader Layer

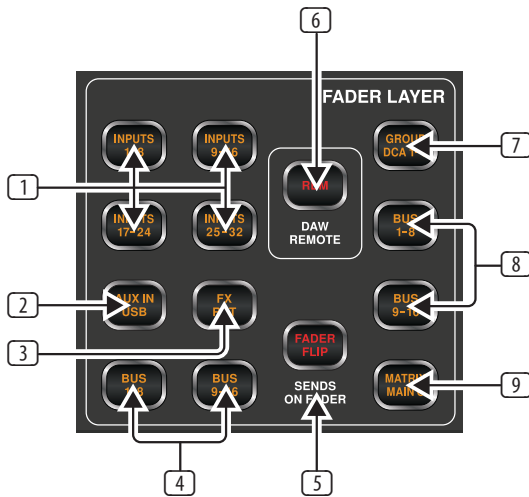

1 INPUTS 1-8 / 9-16 / 17-24 / 35-32

Pressing one of these buttons selects either the channel 1-8 layer, the channel 9-16 layer, the channel 17-24 layer, or the channel 25-32 layer on the left-most eight fader strips.

2 AUX IN / USB

Press to select the Aux In / USB Recorder layer on the left-most eight fader strips.

3 FX RET

Press to select the effects return layer on the left-most eight fader strips.

4 BUS 1-8 / 9-16

Press one of these buttons to select either the Bus 1-8 layer or the Bus 9-16 layer on the left-most eight fader strips.

5 FADER FLIP - SENDS ON FADER Button

Press to activate the M32R's **Sends on Fader** function. This function aids with the level setting of channels sent to any of the 16 Mix Buses. It is only for channels assigned to Mix Buses 1-16, and does not work for DCA groups, main or matrix buses. The **Sends on Fader** function works in two convenient ways to cover the most obvious situations in a live environment:

When preparing a monitor mix for a specified musician

- Select the monitor bus (**BUS 1-8** or **BUS 9-16**) that feeds the musician's stage monitor
- Press the **Sends on Fader** button, which will then flash
- Select one of the three input channel layers (**INPUTS 1-16**, **INPUTS 17-32**, **AUX IN / USB** or **BUS MAST**)
- As long as **Sends on Fader** is active all faders in the input channels section correspond to the send levels on the selected monitor mix bus.

When checking or editing where a selected input signal is to be sent

- Select the input channel in the left-hand section
- Press the **Sends on Fader** button, which will then flash
- Select either bus channel layer (**BUS 1-8** or **BUS 9-16**)
- The bus faders now represent the send levels of the selected input channel.

TIP: *Sends on Fader* can also be used for conveniently sending Bus or Main M/C signals to Matrices.

6 EM - DAW Remote Button

Press this button to enable remote control of your Digital Audio Workstation software using the Group/Bus fader section controls. This section can emulate HUI or Mackie Control Universal communication with your DAW.

7 GROUP DCA 1-8

Press this button to select the Group DCA layer.

A DCA group is a grouping function, made possible by the console's digital operation, where individual input channels can be grouped together and controlled with a single output fader on the right-hand side of the console. Unlike the traditional sub-grouping function found on analogue consoles, a DCA group does not combine the different input channels into a common sub-mix. Instead, the individual input channels still retain their original routing characteristics, but their level adjustments are commonly controlled.

8 BUS 1-8 / 9-16

Press one of these buttons to select either the Bus 1-8 layer or the Bus 9-16 layer on the right-most eight fader strips.

9 MATRIX MAIN C

Press to select the Matrix and Main C layer on the right-most eight fader strips.

2. Main Display

2.1 Main Display - Top Section

The top section of the **Main Display** permanently covers useful status information. The top left corner shows the selected channel number, its user-assigned name and the selected icon. The next block shows the current scene number and name in amber, as well as the next upcoming scene. The centre section displays the playback file name along with elapsed and remaining time, and a recorder status icon. The next block to the right has four segments to show the status of the AES50 ports A and B, the Card slot, and the audio clock synchronisation source and sample rate. Small green square indicators show proper connectivity. The rightmost block shows the console time, which can be set under **Setup - Config**.

2.1.1 Home

The **HOME** screen contains a high-level overview of the selected input or output channel, and offers various adjustments not available through the dedicated top-panel encoders.

The **HOME** screen is divided into the following tabs:

home: General signal path for the selected input or output channel.

config: Allows selection of signal source/destination for the channel, configuration of insert point, and other settings.

gate: Controls and displays the channel gate effect beyond those offered by the dedicated top-panel encoders.

dyn: Controls and displays the channel dynamics effect (compressor) beyond those offered by the dedicated top-panel encoders.

eq: Controls and displays the channel EQ effect beyond those offered by the dedicated top-panel encoders.

sends: Controls and displays the channels sends, such as sends metering and sends muting.

main: Controls and displays the selected channel's output.

home

The **home** tab of the **HOME** screen displays a general signal path for the currently selected input or output channel. It visually displays various parameters of the input, gate, insert point, EQ, dynamics, output path and buses.

The **home** tab contains the following parameters (divided into two pages) that can be adjusted using the six push encoders.



Page 1

1. Turn the first push encoder to adjust the input gain (trim) of the channel.
2. Tap the first encoder to link the channel with its adjacent channel.
3. Adjust the second encoder to set the threshold of the channel noise gate.
4. Tap the second encoder to toggle the channel noise gate in/out of the signal path.
5. Adjust the third encoder to toggle the channel's insert point between pre-fader and post-fader status.
6. Tap the third encoder to toggle the channel insert in/out of the signal path.
7. Adjust the fourth encoder to toggle the channel dynamics between pre-EQ and post-EQ status.
8. Tap the fourth encoder to toggle the channel EQ in/out of the signal path.
9. Adjust the fifth encoder to set the threshold of the channel compressor.
10. Tap the fifth encoder to toggle the channel compressor in/out of the signal path.
11. Adjust the sixth encoder to pan the selected channel within the main stereo output.
12. Tap the sixth encoder to assign the selected channel to the main stereo output.

Page 2

1. Adjust the first push encoder to select the console channel currently controlled by the HOME screen.
2. Tap the first encoder to toggle +48V phantom power on/off for the currently selected input.
3. Tap the second encoder to toggle the phase flip on/off for the currently selected channel.
4. Adjust the third encoder to select to which of the eight DCA groups the currently selected channel will be assigned.
5. Tap the third encoder to assign the currently selected channel to the selected DCA group.
6. Adjust the fourth encoder to select to which of the six mute groups the currently selected channel will be assigned.
7. Tap the fourth encoder to assign the currently selected channel to the selected mute group.
8. Tap the fifth encoder to toggle solo on/off for the currently selected channel.
9. Turn the sixth encoder to adjust the fader level for the currently selected channel.
10. Tap the sixth encoder to toggle mute on/off for the currently selected channel.

config

The **config** tab allows selection of signal source/destination for the channel, configuration of insert point, and other settings, as well as configuration of the channel delay.

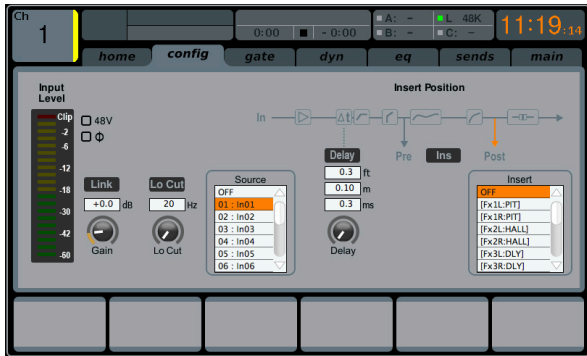

The **config** tab of input channels 1-32 contains the following parameters that can be adjusted using the six push encoders:

1. Turn the first push encoder to adjust the input gain (trim) of the channel.
2. Tap the first encoder to allow linking of the channel to the adjacent channel.
3. Adjust the second encoder to set the low-cut frequency of the channel.
4. Tap the second encoder to toggle the low-cut filter in/out of the signal path.
5. Adjust the third encoder to scroll among all of the possible sources for the channel.
6. Tap the third encoder to select the currently highlighted source and assign it to the channel.
7. Adjust the fourth encoder to set the amount of digital line delay applied to the channel.
8. Tap the fourth encoder to toggle the delay in/out of the signal path.
9. Adjust the fifth encoder to toggle the channel insert between pre- and post-EQ/compressor.
10. Tap the fifth encoder to toggle the channel insert in/out of the signal path.
11. Adjust the sixth encoder to scroll among the signal path choices for the insert point.
12. Tap the sixth encoder to assign the selected signal path to the insert point.

NOTE: Mix Bus channels do not have Gain, Low Cut, Phantom, Phase, Source and Delay. But they do have a macro feature for setting all channel send taps to the selected bus at once. As an example, this can be used for switching all sends from Pre Fader to Post Fader or for ensuring that all channel taps are consistent.

gate

The **gate** tab displays all aspects of the channel noise gate, and allows for very deep control of the gate effect. Whereas the top panel's dedicated **GATE** section allows control of the gate's threshold and in/out status, the gate tab offers many more controls. This tab can be accessed directly by pressing the **VIEW** button in the top panel **GATE** section.



The **gate** tab contains the following parameters, divided among two pages, that can be adjusted using the six push encoders:

Page 1

1. Adjust the first push encoder to set the input threshold of the gate.
2. Tap the first encoder to toggle the noise gate in/out of the signal path.
3. Adjust the 2nd encoder to select between a gate, ducker, or 3 types of expander.
4. Adjust the third encoder to set the attack time of the onset of the noise gate effect.
5. Adjust the fourth encoder to set the hold time of the noise gate effect.
6. Adjust the fifth encoder to set the release time of the noise gate, controlling how quickly the gate opens up and lets the signal through.
7. Adjust the 6th encoder to determine the range of signal reduction.

Page 2

1. Push encoders 1 & 2 function the same on pages 1 & 2.
2. Adjust the fourth encoder to set the frequency of the key filter that can be used to trigger the noise gate.
3. Tap the fourth encoder to toggle the key filter on/off, allowing a specific frequency to control the gate.
4. Adjust the fifth encoder to set the steepness of the EQ slope used in the key filter.
5. Tap the fifth encoder to send the key source to the solo bus, allowing the key source to be monitored and evaluated.
6. Adjust the sixth encoder to select the specific key source to be used. Choices include 'Self' (the channel's own signal), as well as any other input/output of the console.
7. Tap the sixth encoder to assign the selected key source to the gate.

dyn

The **dyn** tab displays all aspects of the channel compressor, and allows for very deep control of the effect. Whereas the top panel's dedicated compressor section allows control of the threshold and in/out status, the **dyn** tab offers many more controls. This tab can be accessed directly by pressing the **VIEW** button in the top panel **DYNAMICS** section.



The **dyn** tab contains the following parameters that can be adjusted using the six push encoders:

Page 1

- Adjust the first push encoder to set the input threshold of the compressor.
- Tap the first encoder to toggle the compressor in/out of the signal path.
- Adjust the second encoder to set the ratio of the compressor.
- Tap the second control to switch the channel dynamics effect between compression and expansion.
- Adjust the third encoder to set the attack time of the compressor effect.
- Tap the third encoder to switch the compressor between Peak and RMS (root mean squared) mode, where the average level of the signal is evaluated more than any specific peak of the channel material.
 - PEAK:** A peak-sensing compressor responds to the instantaneous level of the peak signal. While providing tighter peak control, peak sensing might yield very quick changes in gain reduction, more evident compression, or sometimes even distortion. This mode is suitable for control/limiting of dynamic material.
 - RMS:** In this mode, the compressor applies an average function on the input signal before its level is compared to the threshold. This allows a more relaxed compression that also more closely relates to our perception of loudness. Sharp dynamic transients will be less affected in this mode. This mode is good for controlling levels in a mix.
- Turn the fourth encoder to adjust the hold time of the compressor.
 - Hold time is a parameter not often found on commercial units, but is very useful. If a compressor is set to use a very fast attack/release time, audible distortion can occur, because the compressor is trying to work on individual waveform cycles of the signal instead of the sound envelope as a whole. The Hold parameter works around this issue by providing a short delay. This delay prevents the compressor from releasing until a certain period of time has elapsed.

- Tap the fourth encoder to switch between Linear and Logarithmic modes for the compressor. Following are some brief descriptions of those different modes:

LOG: This mode is used in many well-respected compressors and is the natural result of more recent analogue units employing logarithmic side chains and resistor/capacitor time constants. The exponential/dB law has some interesting characteristics. Firstly the time taken to complete a compression event tends to stay the same however large the dynamic signal excursion is. Also, since the peak rate of gain change increases with dynamic excursion, the resulting harmonic content due to compress tends to follow the loudness of the signal in a way that the ear expects. This helps to mask the effect of the compressor and thus provides the most forgiving solution, being tolerant of differing timing settings and signal material. This makes it the best choice for general compression use and overall dynamic control of complex musical signals.

LINEAR: In this mode, the rate of gain change is constant (as set by the timing controls). Therefore the greater the signal dynamic excursion, the longer the compressor will take to complete a gain change. Also, since the total time that the compressor spends in attack or decay is proportional to the size of the gain excursion, the harmonic content of the compression artefact will seem to reduce in frequency content, the louder the signal excursion. This type of compressor is useful for generating dynamic sound effects because the sonic character of the compressor is much more affected by time control settings and signal material than the exponential type.

- Adjust the fifth encoder to set the release time of the compressor.
- Tap the 5th encoder to engage the "auto" function, which automatically optimizes advanced parameters such as attack, hold and release.
- Adjust the sixth encoder to set the makeup gain of the compressor; useful when the compression effect has reduced the overall signal level of the channel too much.

Page 2

- The 1st encoder still engages and adjusts the threshold.
- Adjust the 2nd encoder to set the mix of the compressor. Normally this would be set to 100%, but by reducing the mix level, an effect called 'parallel compression' can be achieved, allowing some of the signal to pass through uncompressed.
- Adjust the third encoder to set the steepness of the compressor knee angle between five separate settings. Adjust this control to switch between a harder sounding, or more transparent compressor effect.
- Tap the third encoder to move the compressor effect before or after the EQ in the channel signal path.
- Adjust the fourth encoder to set the frequency of the key filter that can be used to trigger the compressor.
- Tap the fourth encoder to toggle the key filter on/off, allowing a specific frequency to control the compressor.
- Adjust the fifth encoder to set the steepness of the EQ slope used in the compressor.
- Tap the fifth encoder to send the key source to the solo bus, allowing the key source to be monitored and evaluated.
- Adjust the sixth encoder to select the specific key source to be used, Choices include 'Self' (the channel's own signal), as well as any other input/output of the console.
- Tap the sixth encoder to assign the selected key source to the compressor.

eq

The **eq** tab displays all aspects of the channel EQ, and also displays a detailed visual graphic of the current EQ curve. This tab can also be accessed directly by pressing the **VIEW** button on the top panel **EQUALISER** section.

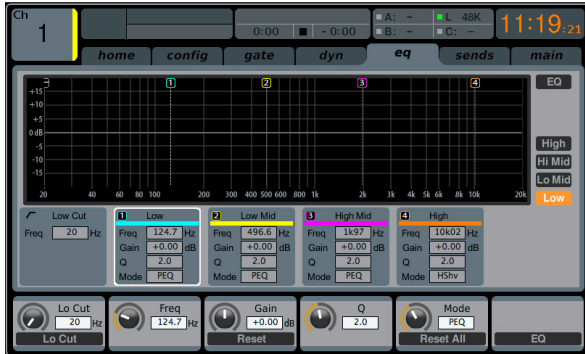

1. If the currently selected channels is an input, the channel EQ contains four bands, with various aspects of each band adjusted by push encoders 2-5.
2. If the currently selected channel is a bus, the channel EQ contains six bands, with various aspects of each band adjusted by encoders 1-6.
3. On the EQ screen, the various push encoders are always tied to an aspect of the frequency adjustment, and the Up/Down navigation controls are used to toggle between the 4 bands. The 6th encoder also toggles which band is active.
 - Adjust the 1st encoder to set the low cut frequency.
 - Tap the 1st encoder to engage the low cut.
 - Adjust the 2nd encoder to adjust the frequency for the selected band. All 4 bands can be shifted between 20 Hz and 20 kHz, so the band labeled 'Low' can actually be used to adjust mids, etc.
 - Tap the 2nd encoder to determine whether the RTA operates as a bar graph or spectrograph.
 - Adjust the 3rd encoder to set the amount of cut or boost for the selected band.
 - Tap the 3rd encoder to set the RTA as pre or post, depending if you want to monitor the incoming signal or the effects of the EQ adjustment.
 - Adjust the 4th encoder to set the bandwidth (Q) of the selected band. This is only available if the band is set to PEQ or VEQ.
 - Tap the 4th encoder to reset the selected EQ band.
 - Adjust the 5th encoder to determine the mode of the selected band. The following options are available:
 - Low cut
 - Low shelf
 - PEQ (standard parametric)
 - VEQ (vintage style)
 - High shelf
 - High cut
 - Tap the 5th encoder to reset all of the EQ bands.
 - Adjust the 6th encoder to select the frequency band.
 - Tap the 6th encoder to activate the EQ.

sends

The **sends** tab displays and controls all aspects of the channel sends to the 16 mix buses. Compared to the dedicated top panel send controls, this screen offers additional functions, such as send muting and simultaneous metering of the selected channel's 16 sends. This tab can also be accessed directly by pressing the **VIEW** button in the top panel **BUS SEND** section.

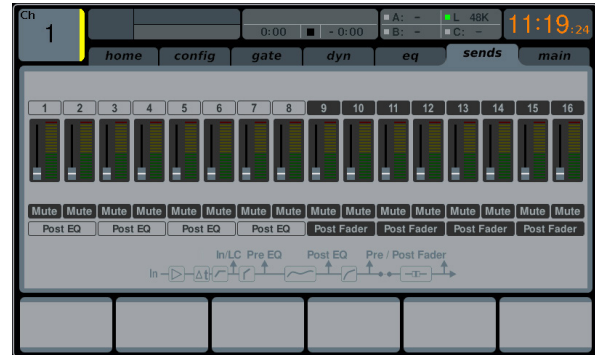

The **sends** tab contains the following parameters that can be adjusted using the six push encoders:

Page 1

1. Adjust the first push encoder to set the level for the first send of the currently selected four-send group.
2. Tap the first encoder to mute the first send of the currently selected four-send group.
3. Repeat the process with the next three encoders for the remaining three sends in the currently selected four-send group.
4. Adjust the sixth encoder to select which four sends to control with the rotary controls, shifting focus two sends at a time.
5. Tap the sixth encoder to select which four sends to control with the rotary controls, shifting focus four at a time.

Page 2

1. Adjust the first push encoder to select from where in the signal chain the send is tapped, for the first two sends of the currently focused four sends. Options include:
 - Pre-EQ
 - Post-EQ
 - Pre-fader
 - Post-fader
 - Sub-group.
2. Adjust the third encoder to perform the same operation for the second two sends of the currently focused four sends.
3. Adjust the sixth encoder to select which four sends to control with the rotary controls, shifting focus two sends at a time.
4. Tap the sixth encoder to select which four sends to control with the rotary controls, shifting focus four at a time.

main

The **main** tab displays and controls all aspects of the main bus assignments.



The **main** tab contains the following parameters that can be adjusted using the six push encoders:

1. Adjust the first push encoder to pan the selected channel within the main stereo output.
2. Tap the first encoder to assign the selected channel to the main stereo output.
3. Turn the second encoder to adjust the level of the currently selected channel within the mono (centre) bus.
4. Tap the second encoder to assign the selected channel to the mono output signal path. Use this function when crafting an LCR mix, as opposed to a mono or stereo mix.
5. Tap the fifth encoder to solo/unsolo the currently selected channel.
6. Adjust the sixth encoder to set the fader level for the currently selected channel.
7. Tap the sixth encoder to mute/unmute the currently selected channel.

2.2 Meters

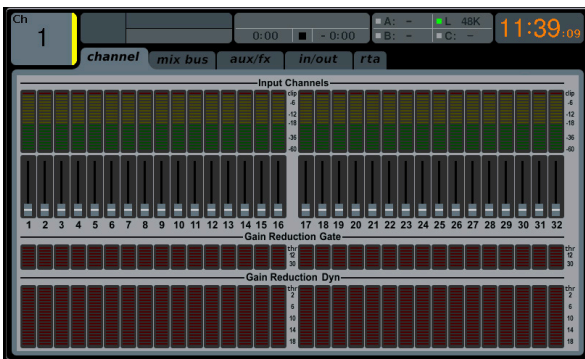

The **METERS** screen displays different groups of level meters for various signal paths on the console, and is useful for quickly ascertaining if any channels need level adjustment. Since there are no parameters to adjust for the metering displays, none of the metering screens (with the exception of the **rta** tab; see below) contain any 'bottom-of-screen' controls that would normally be adjusted by the six push encoders.

The **METERS** screen contains the following separate screen tabs, each containing level meters for the following signal paths:

channel

- Level meters and fader levels for the 32 input channels.

mix bus

- Level meters, fader levels and gain reduction meters for the 16 bus masters
- Level meters, fader levels and gain reduction meters for the six matrix outputs
- Level meters, fader levels and gain reduction meters for the stereo main bus and the mono bus.

aux/fx

- Level meters for the six auxiliary sends
- Level meters and fader levels for the eight auxiliary returns
- Level meters and fader levels for the four stereo effects returns.

in/out

The 32 input channels

The eight auxiliary returns

- The six auxiliary sends
- The two rear panel digital outputs
- Monitor outputs
- The 16 rear panel analogue outputs
- The P16 ULTRANET outputs.

rta

The **rta** tab shows details of the M32's Real Time Analyser - a real-time spectrum analyser that displays details of the audio signal on the selected signal path. The M32 features both bar graph and spectrograph with a 10-second window, that are displayed on the Main Display, and can be used in a variety of applications. The frequency resolution of both analysers is 100 bands, with constant relative bandwidth from 20 Hz to 20 kHz. Hence they are three times more detailed than typical third-of-an-octave RTAs. Both graphs can be visualised in a separate Meter screen, on top of each channel parametric EQ and on the FX rack graphic EQ screens.

RTA Source

Depending on the application the analyser input signal can be taken from the selected channel itself, any other pre-defined channel or dynamically depending on monitor source signals (i.e. Main/Solo). When EQ-ing a main PA system for example, the Graphic EQ may be inserted in Main LR, while the analyser signal may come from a dedicated measuring mic input channel. Select the source signal using the sixth push encoder.



Solo Priority

When switched on, the selected RTA source signals will be replaced with the monitor solo bus whenever a channel solo is active.

TIP: This option might be useful, if you wish to analyse a group of channels concurrently, or if you have a fixed signal on the RTA that needs to be replaced only temporarily with some other channel's signal.

Pre / Post

The analysers can tap their input signals from pre- or post-EQ, allowing you to see the impact of your EQ in that channel. Tap the fifth push encoder to toggle between the two.

Gain

When engaged, the Auto Gain function simplifies adjusting the analyser views and ensuring meaningful readings. In most cases it should be switched on. When switched off, the RTA gain can be set manually using the push encoder, which may be necessary for comparing absolute frequency band levels between different channels. Tap the fourth push encoder to engage the Auto Gain function.

EQ Overlay

When using the analysers on top of the channel EQ plot or over the graphic EQ screens, the meter's opacity can be adjusted to your liking. Something around 50% is typically a good starting point. Turn it down to 0% with the fifth push encoder if you don't need to see the RTA on top of the channel EQ or graphic EQ screens.

RTA On Channel EQ View

The channel EQ RTA function will always display the respective channel's frequency distribution, independent from the RTA Source definition. Use the EQ Overlay control for adjusting the amount of RTA on top of the EQ plot. Default preferences when opening any channel EQ view can be set to 'Pre-EQ' (off is Post-EQ) and 'Spectrograph' (off is bar graph). They can however be overruled on the respective EQ page.

RTA On Graphic EQ View

The Graphic EQ RTA function will always display the respective FX slot's frequency distribution, independent from the RTA Source definition, unless the 'Use RTA Source' mark is ticked. Use the EQ Overlay control for adjusting the amount of RTA on top of the GEQ sliders. Default preferences when opening any GEQ view can be set to 'Post-GEQ' (off is pre-graphic EQ) and 'Spectrograph' (off is bar graph). They can however be overruled on the respective GEQ page.

2.3 Routing

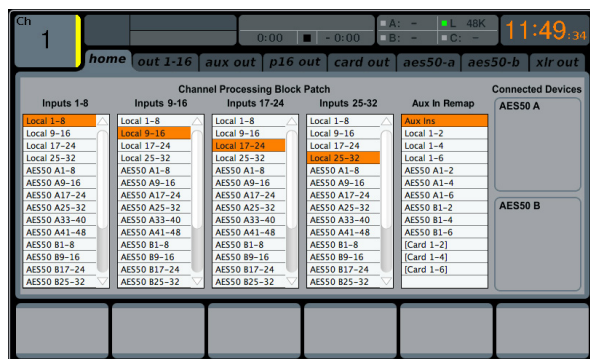

The **ROUTING** screen is where all signal patching is done, allowing you to route internal signal paths to and from the physical input/output connectors located on the M32R's rear panel.

The **ROUTING** screen contains the following separate tabs:

home: Allows patching of physical inputs to the 32 input channels and auxiliary inputs of the console.

out 1-16: Allows patching of internal signal paths to the console's 8 rear-panel XLR outputs.

aux out: Allows patching of internal signal paths to the console's six rear-panel 1/4" RCA auxiliary outputs.

p16 out: Allows patching of internal signal paths to the 16 outputs of the console's 16-channel P16 ULTRANET output.

card out: Allows patching of internal signal paths to the 32 outputs of the DN32-USB card.

aes50-a: Allows patching of internal signal paths to the 48 outputs of the rear-panel AES50-A output.

aes50-b: Allows patching of internal signal paths to the 48 outputs of the rear-panel AES50-B output.

xlr out: Allows patching of internal signal paths to the XLR out connections on the rear.

None of the **ROUTING** screen's tabs contain a secondary level of functions.

When routing audio, the Up/Down navigation controls do not need to be used.

home

The **ROUTING** screen's **home** tab allows the user to patch the M32R's physical rear-panel inputs to the 32 input channels and auxiliary inputs of the console.

As a default, the M32R maps its 16 rear panel inputs to the first 16 channel inputs that are accessed on input fader layers one and two, and maps the rear-panel line-level (auxiliary) inputs to the 'Aux In 1-6 / USB REC' fader level.

However, the **home** tab of the **ROUTING** screen can be used to change this default assignment and cross-patch different physical inputs to different channel inputs, in banks of eight channels at a time. This allows the user to create a custom layer of channel inputs that differs from the order that the sources are plugged into the rear panel, and is easier than physically re-patching audio cables.

To assign various inputs to the M32R's input channels, perform the following steps:

1. Adjust the first push encoder to select which 8-channel audio input source feeds input channels 1-8 of the console. As the control is rotated, the currently selected input will be highlighted in the vertical list of choices.
2. When the desired 8-channel source is selected, push the first push encoder to connect the currently selected 8-channel source. The selected source now feeds input channels 1-8 of the console.
3. Input choices that can be assigned include:
 - Local 1-8
 - Local 9-16
 - Local 17-24
 - Local 25-32
 - AES50-A 1-8
 - AES50-A 9-16
 - AES50-A 17-24
 - AES50-A 25-32
 - AES50-A 33-40
 - AES50-A 41-48
 - AES50-B 1-8
 - AES50-B 9-16
 - AES50-B 17-24
 - AES50-B 25-32
 - AES50-B 33-40
 - AES50-B 41-48
 - Card 1-8
 - Card 9-16
 - Card 17-24
 - Card 25-32.

4. To assign an 8-channel source from the other input channels of the console (9-16, 17-24, 25-32), simply repeat the process above, using the other four push encoders on the same screen.
5. Choices for Aux 1-4 include:
 - Aux Ins
 - Local 1-2
 - Local 1-4
 - Local 1-6
 - AES50A 1-2
 - AES50A 1-4
 - AES50A 1-6
 - AES50B 1-2
 - AES50B 1-4
 - AES50B 1-6
 - Card 1-2
 - Card 1-4
 - Card 1-6.

out 1-16

The **ROUTING** screens **out 1-16** tab allows the user to patch the M32R's various internal signal paths to the 8 analogue XLR outputs that are located on the console's rear panel.

The M32R allows for many different kinds of output signal paths, and this screen is where these outputs are assigned to a physical rear panel output, so that the signal path can be patched to their eventual destination, such as front-of-house PA speakers or a powered stage monitor.

To assign the various output paths to the rear panel XLR outputs, perform the following steps:

1. Adjust the first push encoder to select to which of the 8 rear panel analogue outs you wish to assign an output signal path.
2. Adjust the third encoder to select an output path category. These include:
 - Off
 - Main (LRC) Mix
 - Mix Bus Outputs
 - Matrix Outputs
 - Direct Outs
 - Monitor.
3. Adjust the fourth encoder to select a specific output path, including:
 - Off
 - Main L
 - Main R
 - Main C/M
 - Any of the 16 Mix Outputs
 - Any of the six Matrix Outputs
 - Any of the 32 Direct Outputs
 - Any of the eight Auxiliary Outputs
 - Any of the FX Direct Outputs
 - Monitor L
 - Monitor R
 - Talkback. Tap the fourth encoder to assign the selected output path, completing the process.

- Adjust the fifth encoder to select the signal tap point for the output assignment. This determines where in the audio signal path the source is 'tapped' as it is sent to the physical rear panel output. The available signal tap points include:
 - IN/LC
 - IN/LC +M
 - PreEQ
 - PreEQ +M
 - PostEQ
 - PostEQ +M
 - PreFdr
 - PreFdr +M
 - Post Fader.
- 4. Tap the fifth encoder to assign the selected signal tap point.
- 5. Turn the sixth encoder to adjust the amount of digital line delay applied to the output path as it is sent to the rear panel physical output. As the amount of delay is adjusted, the current delay time is displayed in three different units of measurement: feet, metres and milliseconds.
- 6. Tap the sixth encoder to toggle delay on/off. The **Delay** label illuminates when the delay is inserted into the signal path.

TIP: Applying a delay to an output signal is typically done when the console is used in a 'multi-zone' PA speaker setup, where some PA speakers are located near the stage, and a second set of speakers is located further back within the audience. By applying an appropriate amount of delay only to the speakers located near the stage, the audience hears the audio from all speakers at the same time, ensuring maximum time-alignment and sound quality. The M32 assumes an operating temperature of 20°C/68°F when calculating the delay times.

aux out

The **ROUTING** screen's **aux out** tab allows the user to patch an internal signal path (such as a mix output used as an effects send) to the six separate ¼"/RCA auxiliary outputs.

Since these six outputs can have a wide variety of signal paths assigned to them, they can be used for a wide variety of tasks, such as:

1. Feeding an external effects processor when the internal effects are insufficient.
2. Patching a specific console signal path to an outboard recorder.
3. Feeding the analogue or digital audio inputs of a nearby video recorder.

To make an assignment as described above, perform the following steps:

1. Adjust the first push encoder to select to which auxiliary outputs to assign a source. Choices include
 - Aux Out 1
 - Aux Out 2
 - Aux Out 3
 - Aux Out 4
 - Aux Out 5
 - Aux Out 6
 - AES/EBU (Digital) Out L
 - AES/EBU (Digital) Out R.
2. Adjust the third encoder to select for coarse range:
 - Insert
 - Main (LRC)
 - Mix Bus
 - Matrix
 - Direct Out
 - Monitor.

3. Adjust the fourth encoder to select a specific signal path to feed the selected physical output. Choices include:
 - Insert Point
 - Main L
 - Main R
 - Main C/M
 - Any of the 16 Mix Outputs
 - Any of the six Matrix Outputs
 - Any of the 32 Direct Outputs
 - Any of the eight Auxiliary Outputs
 - Any of the FX Direct Outputs
 - Monitor L
 - Monitor R
 - Talkback.
4. Tap the fourth encoder to assign the selected output path, completing the process.
5. Adjust the fifth encoder to select the signal tap point for the output assignment. Choices include:
 - IN/LC
 - IN/LC +M
 - PreEQ
 - PreEQ +M
 - PostEQ
 - PostEQ +M
 - PreFdr
 - PreFdr +M
 - Post Fader.
6. Tap the fifth encoder to complete the signal tap point assignment.
7. Tap the 6th encoder to enter iQ Setup
 - Adjust the 1st encoder to select a P16 channel.
 - Adjust the 3rd encoder to select the iQ speaker assigned to the selected channel. Press the encoder to confirm.
 - Adjust the 4th encoder to select an EQ Preset, then press the encoder to confirm.
 - Adjust the 5th encoder to select a Sound Profile that the iQ speaker will model, then press the encoder to confirm.
 - Press the 6th encoder again to return to the P16 tab.

p16 out

The **ROUTING** screen's **p16 out** tab allows the user to route various console signal paths to the rear panel P16 ULTRANET output. This output allows for 16 channels of audio to be sent, in digital form, to various accessories such as a personal monitoring distribution box.

Using the **p16 out** routing screen, the user can configure the P16 output to carry not only the main LR mix, but also various audio 'stems' of audio material sources from a bus send mix, such as a stereo drum mix, stereo keyboards, guitars, bass, vocals, etc. Musicians on stage would then be free to each craft their own personal mix of these musical stems, all delivered from the FOH position to stage over a single Ethernet cable.

To select which audio signals are sent to the P16 bus, perform the following steps:

1. Adjust the first push encoder to select for which of the 16 channels in the P16 bus you wish to select an audio source.
2. Adjust the third encoder to select a category of audio source to send to the currently selected P16 channel. These categories include:
 - Insert
 - Main (LRC)
 - Mix Bus
 - Matrix
 - Direct Out
3. Monitor. Adjust the fourth encoder to select which specific signal path to feed to the currently selected P16 output. Choices include:
 - Off
 - Main L
 - Main R
 - Main C/M
 - Any of the 16 Mix Outputs
 - Any of the six Matrix Outputs
 - Any of the 32 Direct Outputs
 - Any of the eight Auxiliary Outputs
 - Any of the FX Direct Outputs
 - Monitor L
 - Monitor R
 - Talkback.
4. Tap the fourth encoder to assign the selected output path, completing the process.
5. Adjust the fifth encoder to select the signal tap point for the output assignment. This determines where in the audio signal path the source is 'tapped' as it is sent to the P16 output. The available signal tap points include:
 - IN/LC
 - IN/LC +M
 - PreEQ
 - PreEQ +M
 - PostEQ
 - PostEQ +M
 - PreFdr
 - PreFdr +M
 - Post Fader.
6. Tap the fifth encoder to complete the signal tap point assignment.

card out

The **ROUTING** screen's **card out** tab allows the user to patch various signal paths to the physical inputs and outputs on the DN32-USB card. The card's signal path provides 32 channels of inputs and 32 channels of outputs. The 32 card inputs can be used as alternative sources for the two input fader layers, switchable in banks of eight.

To assign an output path to the option card, perform the following steps:

- Adjust the first push encoder to select an 8-channel signal path that will be sent to the first eight channels of the card. Choices include:
 - Local 1-8
 - Local 9-16
 - Local 17-24
 - Local 25-32
 - AES50-A 1-8
 - AES50-A 9-16
 - AES50-A 17-24
 - AES50-A 25-32
 - AES50-A 33-40
 - AES50-A 41-48
 - AES50-B 1-8
 - AES50-B 9-16
 - AES50-B 17-24
 - AES50-B 25-32
 - AES50-B 33-40
 - AES50-B 41-48
 - Card 1-8
 - Card 9-16
 - Card 17-24
 - Card 25-32
 - Out 1-8
 - Out 9-16
 - P16 1-8
 - P16 9-16
 - Aux 1-6/Mon.
- Tap the first encoder to assign the selected output path, completing the process.
- Repeat the process with encoders 2-4 to select output paths for the other 24 channels or card outputs.

aes50-a / aes50-b

The **ROUTING** screens *aes50-a* and *aes50-b* tabs allow the user to patch various console output paths to the outputs of the dual AES50 connectors. These connectors can feed other AES50-equipped devices, such as a digital stage box or standalone multi-track recorder.

The M32R contains two separate AES50 connectors, labelled A and B. These dual connectors allow for an increased level of flexibility in networking the console to various AES50-based equipment.

Each of the two AES50 tabs contains the same following sets of parameters that can be adjusted. To assign various console signal paths to the AES50 connectors, perform the following steps:

- Adjust the first push encoder to select an 8-channel signal path that will be sent to the first eight channels of the AES50 connector's output. Choices include:
 - Local 1-8
 - Local 9-16
 - Local 17-24
 - Local 25-32
 - AES50-A 1-8
 - AES50-A 9-16
 - AES50-A 17-24
 - AES50-A 25-32
 - AES50-A 33-40
 - AES50-A 41-48
 - AES50-B 1-8
 - AES50-B 9-16
 - AES50-B 17-24
 - AES50-B 25-32
 - AES50-B 33-40
 - AES50-B 41-48
 - Card 1-8
 - Card 9-16
 - Card 17-24
 - Card 25-32
 - Out 1-8
 - Out 9-16
 - P16 1-8
 - P16 9-16
 - Aux 1-6/Mon.
- Tap the first encoder to connect the currently selected signal path to the AES50 pathway.
- Repeat the above process for the other five sets of 8-channel AES50 outputs.

The *aes50-b* tab works exactly the same as the *aes50-a* tab, but instead selects sources sent to the output of the console's AES50-B connector.

xlr out

The **ROUTING** screen's *xlr out* tab, much like the *out 1-16* tab, allows the user to patch the M32R's various internal signal paths to the 8 analogue XLR outputs that are located on the console's rear panel. This tab, however, allows the XLR outputs to be patched in blocks of four, rather than individually. Also, on this screen it is only possible to route the signal to its absolute destination, rather than choosing the signal path. The available destinations will differ depending on the block selected. Destinations include:

Block 1-4 / Block 9-12

- Local 1-4
- Local 9-12
- Local 17-20
- Local 25-28
- AES50-A 1-4
- AES50-A 9-12
- AES50-A 17-20
- AES50-A 25-28
- AES50-A 33-36
- AES50-A 41-44
- AES50-B 1-4
- AES50-B 9-12
- AES50-B 17-20
- AES50-B 25-28
- AES50-B 33-36
- AES50-B 41-44
- Card 1-4
- Card 9-12
- Card 17-20
- Card 25-28
- Out 1-4
- Out 9-12
- P16 1-4
- P16 9-12
- Aux 1-4
- Auxin 1-4.

Block 5-8 / Block 13-16

- Local 5-8
- Local 13-16
- Local 21-24
- Local 29-32
- AES50-A 5-8
- AES50-A 13-16
- AES50-A 21-24
- AES50-A 29-32
- AES50-A 37-40
- AES50-A 45-48
- AES50-B 5-8
- AES50-B 13-16
- AES50-B 21-24
- AES50-B 29-32
- AES50-B 37-40
- AES50-B 45-48
- Card 5-8
- Card 13-16
- Card 21-24
- Card 29-32
- Out 5-8
- Out 13-16
- P16 4-8
- P16 13-16
- Aux 5-6/Mon
- Auxin 5-6/TB.

2.4 Library

The **LIBRARY** screen allows loading and saving of commonly used setups for the channel inputs, effects processors and routing scenarios.



The **LIBRARY** screen contains the following separate tabs:

channel: This tab allows the user to load and save commonly used combinations of the channel DSP effects.

effects: This tab allows the user to load and save commonly used effects processor presets.

routing: This tab allows the user to load and save commonly used signal routings.

channel

The **LIBRARY** screen's **channel** tab allows you to load and save commonly used combinations of the channel DSP effects. For example, once you have dialled in a combination of EQ and compression that works well for a particular singer, you can save the channel DSP chain as a preset for later recall.

To adjust the various settings on the **channel** tab, perform the following steps:

- Adjust the first push encoder to select which specific elements of the input channel can be recalled when loading an input channel preset. Choices include:
 - Head Amp (Microphone Preampifier)
 - Configuration
 - Gate
 - Compressor
 - Equalizer
 - Sends.
- Tap the first encoder to turn the currently selected element on or off in the recall list.
- Adjust the second encoder to scroll among a list of input channel presets.
- Tap the second encoder to load the currently highlighted preset and make it active on the currently selected console channel.
- Adjust the third encoder to scroll among a list of channel preset slots to save the current state of the currently selected console channel.
- Tap the third encoder to save the currently selected channel's state to the currently selected preset slot.
 - When the third encoder is tapped, a preset naming screen appears. Adjust and tap encoders 4-6 to apply a custom name to the preset before saving it, then tap the sixth encoder to complete the save process.
- Tap the fourth encoder to delete a preset from the currently highlighted preset slot.

effects

The **LIBRARY** screen's **effects** tab allows you to load and save presets for the various onboard effects processors.

To adjust the various settings on the **effects** tab, perform the following steps:

Adjust the first push encoder to select which of the eight effects slots to load or save a preset.

As you navigate among the eight effects slots the specific effect processor loaded into each slot will display on the screen as both a name and an icon.

To save and load presets, as well as import/export them, follow the same procedure as detailed in the **LIBRARY** screen **channel** tab.

routing

The **LIBRARY** screen's **routing** tab allows you to load and save presets of the M32R's signal routings. This can be useful for repeating specific routing scenarios that occur over and over on a regular basis, such as when using the console for a weekly club gig or worship service.

To adjust the various settings on the **routing** tab, perform the following steps:

- Adjust the first push encoder to select which specific console signal paths will be recalled when loading a routing preset. Choices include:
 - Channel Inputs
 - Analog Out
 - Auxiliary Out
 - P16 (ULTRANET) Out
 - Card Out
 - AES50 Out.
- Tap the first encoder to turn the currently selected element on or off in the recall list.
- To save and load presets, as well as import/export them, follow the same procedure as detailed in the **LIBRARY** screen **channel** tab.

2.5 Effects

The **EFFECTS** screen controls various aspects of the eight internal effects processors. On this screen the user can select specific types of effects for the eight internal processors, configure their input and output paths, monitor their levels, and adjust the various effect parameters.

The first four slots can be Insert and Side-Chain effects, and the slots five to eight are Insert only. Additionally these slots can only hold some effects excluding reverbs and other power-intensive effects. They also have different selections for the input sources.

The **EFFECTS** screen contains the following separate tabs:

home: The home tab provides a general overview for all eight effects processors, displaying what effect has been inserted in each of the eight slots, as well as displaying input/output paths for each slot, and the I/O signal levels.

fx1-8: These eight duplicate screens display all relevant data for the eight separate effects processors, allowing the user to adjust all parameters for the selected effect.

home

The **EFFECTS** screen's **home** tab provides a high-level overview of the eight effects processor slots, giving the user at-a-glance feedback on the effects they have assigned to the slots, the console source and destination for each processor, and the input/output levels for each processor.

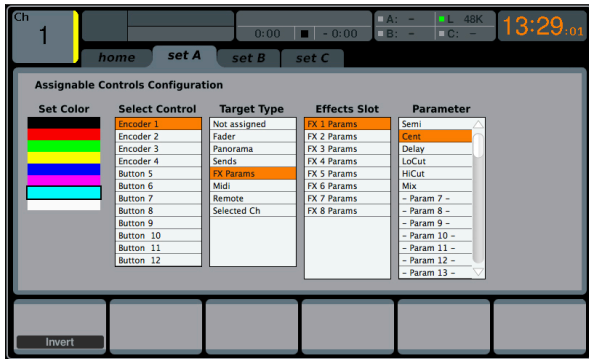

To make adjustments on the **EFFECTS** screen's **home** tab, perform the following steps:

- Adjust the first push encoder to select the input source for the currently highlighted effects block. Signal path choices include:
 - Insert Send
 - Mix Bus 1-16.
- Tap the first encoder to assign the currently selected input source.
- Adjust the second encoder to select the input source for the right side of the currently highlighted effects block.
- Tap the second encoder to assign the currently selected input source.

TIP: To configure an effect as mono input and stereo output, set both input sources to the same signal path

- Tap the third and fourth encoders to mute the currently selected effect.
- Adjust the fifth encoder to scroll among the different audio effects available. Choices include:

Hall Reverb	Delay + Chamber	M/S Fair Comp
Ambience	Chorus + Chamber	Dual Fair Comp
Rich Plate Reverb	Flanger + Chamber	Leisure Comp
Room Reverb	Delay + Chorus	Dual Leisure Comp
Chamber Reverb	Delay + Flanger	Ultimo Comp
Plate Reverb	Modulation Delay	Dual Ultimo Comp
Vintage Reverb	Dual Graphic EQ	Dual Enhancer
Vintage Room	Stereo Graphic EQ	Stereo Enhancer
Gated Reverb	Dual TruEQ	Dual Exciter
Reverse Reverb	Stereo TruEQ	Stereo Exciter
Stereo Delay	Dual DeEsser	Stereo Imager
Triple Delay	Stereo DeEsser	Edison EX1
Rhythm Delay	Stereo Xtec EQ1	Sound Maxer
Stereo Chorus	Dual Xtec EQ1	Dual Guitar Amp
Stereo Flanger	Stereo Xtec EQ5	Stereo Guitar Amp
Stereo Phaser	Dual Xtec EQ5	Dual Tube Stage
Dimension-C	Wave Designer	Stereo Tube Stage
Mood Filter	Precision Limiter	Dual Pitch Shifter
Rotary Speaker	Combinator	Stereo Pitch
Tremolo / Panner	Dual Combinator	
Suboctaver	Fair Comp	

- Tap the fifth encoder to assign the selected effect to the currently highlighted effects slot.
- Adjust the sixth encoder to scroll among the eight effects slots to select one for editing.
- Tap the sixth encoder to go to the edit page for the currently highlighted effects slot.

fx1-8

The **EFFECTS** screen's **fx 1-8** tabs allow you to edit the parameters for the specific effect processor assigned to the corresponding effects slot.

In order to more closely simulate the look and feel of the outboard processors that are no longer necessary with a digital console, the individual effects processor screen provides a graphical representation of the effects processor's real world physical counterpart. This provides greater ease of use for the user than a simple text list of parameters.

To make adjustments on the **EFFECTS** screen's editing tab, perform the following steps:

- Adjust the six push encoders to change the various effects parameters shown at the bottom of the screen.
- Use the Up/Down navigation controls to switch the push encoders to a second, third or fourth set of parameters for effects that contain more than six adjustable parameters.
- When the effects processor has been edited to your satisfaction, push the sixth encoder to go back to the **EFFECTS** screen's **home** tab.
- See the **Main Display - Internal Effects** section for more details on specific effects and parameters.

TIP: For the Graphics EQ effects, tap the first push encoder to implement the 'Graphics EQ on Faders' function. This allows you to boost or cut the different EQ bands using the eight console output faders, eight faders at a time, with the relevant EQ bands displayed on the channel LCD screens.

Adding one of the 8 internal effects

There are two types of effects that are commonly used:

- "Effects Loop" (side chain) style effects, where multiple channels all send varying amounts of their signal to a common effect, such as a reverb, delay, or chorus.
- "Insert" style effects that are inserted in to the signal path of a single channel of audio. Examples would be a graphic EQ, filter, exciter, or tube emulator.

To apply an "Effects Loop" style effect:

- Press the "FX" menu button. The main screen will show the FX home screen where different effects processors are assigned to the 8 processing slots.
- Adjust rotary encoder #6 to highlight the first effects processor; it will be surrounded by an orange outline.
- Adjust rotary encoder #1 and rotary encoder #2, selecting your desired bus as the source for both the left and right inputs of the first effect processor. By default, FX 1 is sourced from Bus 13.
- Adjust rotary encoder #5 to select a specific effect processor, such as "Ambience".
- Select the fader bank button labeled "RTN" on the left side of the console. Bring the faders labeled FX1L and FX1R up to 0 dB in case they are not set to this value by default. In the initial setup, these returns are stereo linked and automatically send to the main LR bus, but it is also possible to send them to the other buses as well. For this, press the HOME button next to the screen while the return is selected, then go to the SENDS tab with the PAGE SELECT right button and adjust the send levels for the return to the other buses, or use the dedicated BUS SENDS controls.

- Back on the EFFECTS page, press the PAGE SELECT right button to switch the screen to the editor for the Ambience processor. The screen will switch to an editor page for the first processor. Adjust the rotary encoders to tailor the effect to your liking.
- To apply the effect to assorted input channels, select an input channel, then adjust its “Bus Send 13” knob to taste. As the bus send level is increased, more of the channel signal will be sent to the Ambience effect. Repeat this process with other channels you wish to send to the Ambience processor.

To apply an “insert” style effect:

- Press the “EFFECTS” menu button.
- As the effects on the left side are also able to handle complex send effects like reverb, the slots on the right side shall be used for insert effects like limiter, graphic EQ, etc. You can also use insert effects on the left side, but this will limit your use of reverbs and other processor-intensive effects.
- Adjust rotary encoder #6 to highlight one of the effects processors on the right side; it will be surrounded by an orange outline.
- Adjust rotary encoder #1 and rotary encoder #2, selecting “Insert” as the source for both the left and right inputs of the effect processor.
- Adjust rotary encoder #5 to select a specific effect processor, such as “precision limiter”.
- Select the specific input or output channel you wish to use the inserted effect on.
- Press the HOME button, then the PAGE SELECT right button to navigate to the selected channel’s “Config” screen.
- Adjust rotary control #6 to select the specific processor you have applied the effect to, in this case “Ins FX 5L”. Press the encoder to connect the selected insert effect.
- The Precision Limiter is now applied as an insert on the selected channel. Sending more than one channel through the same insert effect is, of course, prohibited. There will be a warning when you try to insert an effect slot that has already been used as an insert on any other channel. Both sides of a dual type effect can be used as inserts on different channels or buses.

2.6 Setup

The **SETUP** screen offers various controls for global, high-level functions of the M32R, such as display adjustments, sample rates and synchronisation, user settings, and network configuration.

The **SETUP** screen contains the following separate tabs:

global: This screen offers adjustments for various global preferences of how the console operates.

config: This screen offers adjustments for sample rates and synchronisation, as well as configuring high-level settings for signal path buses.

remote: This screen offers different controls for setting up the console as a control surface for various DAW recording software packages on a connected computer.

network: This screen offers different controls for attaching the console to a standard Ethernet network.

scribble strips: This screen offers controls for various aspects of the console’s DCA groups.

preamps: This screen allows the gain on each of the individual input channels’ preamps to be adjusted.

card: This screen selects the input/output configuration.

None of the **SETUP** screen’s tabs contain a secondary level of functionality, so the UP/DOWN navigation controls do not need to be used for these screens.

global

The **SETUP** screen’s **global** tab allows the user to adjust various global controls of the console, such as display brightness and contrast, sample rate, and the time and date.

To make adjustments in the global screen, perform the following steps:

1. Adjust the 1st encoder to select from the list of System Controls:
 - Shutdown
 - Reboot
 - Update Firmware
2. Tap the 1st encoder to engage the selected function.
3. Adjust the 2nd encoder to select the sample rate and synchronization.
4. Tap the 2nd encoder to confirm your selection.
5. Adjust the 4th encoder to select an item to initialize.
6. Tap the 4th encoder to initialize your selection.
7. Adjust the 5th encoder to change the currently selected figure for the time or date.
8. Tap the 5th encoder to scroll through the entries for time and date.
9. Adjust the 6th encoder to change the LCD or LED brightness.
10. Tap the 6th encoder to alternate between LCD and LED brightness.

config

The Config tab allows a variety of global preferences to be selected. All of the adjustments are made with just 3 encoders.

1. Adjust the 1st encoder to scroll through the list of preferences.
2. Tap the 1st encoder to confirm the selection.
3. Adjust the 4th encoder to scroll through the list of Link and Pan preferences.
4. Tap the 4th encoder to confirm.
5. Adjust the 5th encoder to select a bus pre-configuration scheme. Note that individual channels and buses can be changed on the Sends screen.
6. Tap the 5th encoder to select the configuration.

remote

The **SETUP** screen’s **remote** tab allows the M32R to be set up as a control surface for various DAW recording software on a connected computer. With its large complement of motorised faders, the console can act as an excellent controller, allowing the user to make level adjustments quickly and easily without using a mouse.

To adjust the various remote settings, perform the following steps:

1. Tap the 1st encoder to enable the console’s top panel Remote button. This switches various console hardware, such as the bus faders, to control computer DAW software instead of the console’s internal audio path.
2. Adjust the 2nd encoder to select the specific control surface protocol used, in conjunction with the target DAW software. Choices include:
 - Mackie Control: Use this protocol to control any DAW software that is compatible with a Mackie Control hardware control surface.
 - HUI: Use this protocol to control any D.A.W. software that is compatible with a HUI hardware control surface, such as Pro Tools.
3. Tap the 2nd encoder to assign the currently selected control surface protocol.
4. Adjust the 5th encoder to select whether the remote function uses the MIDI In and OUT jacks or the DN32-USB card’s MIDI.
5. Tap the 5th encoder to confirm the selection.

6. Adjust the 6th encoder to adjust various MIDI-based operations for the console. Choices include:
 - MIDI In/Out: This toggles the MIDI input and outputs for the console on/off.
 - Card MIDI: Allows MIDI transmission through the DN32-USB card.
 - USB In/Out: This toggles the console's USB ports on/off.
 - RTP (Real-time Transport Protocol): This toggles on/off the console's ability to interface with an Ethernet-based MIDI system.
 - Enable MIDI scene recall: This toggles on/off the console's response to incoming MIDI messages for switching console scenes.
7. Tap the 6th encoder to toggle the currently selected MIDI option on/off. This can be useful if you want to ensure that any connected MIDI transmitters cannot interfere with the console.

network

The **SETUP** screen's **network** tab contains settings used when connecting the M32R to a standard Ethernet network. The user can set parameters such as using a fixed IP address, or having one assigned, as well as setting up Ethernet and subnet mask settings.

To set the network address for the console, perform the following steps:

1. Adjust the first push encoder to select which specific network field to adjust. Choices include:
 - IP address
 - Subnet Mask
 - Gateway.
2. Adjust encoders 2, 3, 4 and 5 to set the four numerical fields to be adjusted for the selected network field. Set an IP address which fits your network, normally 192.168.0.X. The IP address should be free within the network. Set your subnet mask according to your network, normally 255.255.255.0, and set your gateway if required.
3. Tap the sixth encoder to assign the adjusted settings.

Now get your iPad or remote PC into the same network and open the M32-Mix or M32-Edit software.

PC:

- On the M32-Edit, choose setup on the right side and the network tab. Enter the IP address of the M32R in the network and press connect.
- If the software has connected to the M32R you can also synchronize them in 2 directions. Console -> PC means all settings in the M32R will be loaded into the M32-Edit software. PC -> Console means that all settings in the M32-Edit will be written to the console.

M32-Mix

- For the M32-Mix remote, open the program on your iPad (make sure the iPad is connected to the same network as the console).
- On the startup screen, a popup should appear. Enter the IP of the console, press "Go Online", et voila: you are connected and can control the M32R with your iPad.

scribble strip

The **SETUP** screen's **scribble strips** tab allows customisation for all of the M32R's channel LCD displays, including Aux, FX, Buses, Matrices and DCAs.

On the **scribble strips** tab the user can make useful adjustments, such as assigning real names to the selected channel (such as 'drums' or 'backing vocals'), as well as assigning colours to them that are then reflected on the console's channel LCD screens.

1. Adjust the 1st encoder to select the channel, bus, matrix, DCA group, etc. you wish to edit.
2. Adjust the 2nd encoder to set the color for the currently selected channel.
 - The selected color will be shown in the LCD screen above the selected channel's fader. For example, if DCA#5 is assigned the color red, the LCD screen above output fader #5 will illuminate in red.
3. Adjust the 3rd encoder to select the graphical icon for the channel. A large variety of clip-art is available to represent various input sources and output destinations.
4. Adjust the 4th encoder to select a name from a list of common preset names (snippets), for the currently selected channel.
5. Tap the 4th encoder to assign the currently highlighted preset text (snippet) to the channel.
6. Tap the 5th encoder to edit the channel name. An edit screen will pop up.
7. Adjust the 4th encoder to shift the cursor position.
8. Tap the 4th encoder to issue a "backspace" command, deleting the currently highlighted character.
9. Adjust the 5th encoder to select a letter, number, or symbol to enter into the channel's name field.
10. Tap the 5th encoder to insert the currently highlighted letter, number, or symbol into the channel's name field.
11. Adjust the 6th encoder to select whether the text entry choices offer capitals, normal characters, or numbers and symbols.
12. Tap the 6th encoder to exit the editing page, and save the current parameters to the channel.

preamps



The Preamps tab allows the digital trim to be adjusted for all local and AES50 channels.

1. Adjust the 1st encoder to select a block of 8 channels.
2. Adjust encoders 2-5 to set the preamp gain for the top or bottom row of inputs.
3. Tap encoders 2-5 to toggle phantom power on and off.

Note - Use the Layer Up and Down buttons to select the top or bottom row of inputs for editing.

4. Rotate the 6th encoder to select one of 4 checkboxes, then press the encoder to mark the box and activate that function.

Lock Stagebox prevents front panel adjustments to be made on a connected S16 digital snake.

HA Gain Split separates the channel gain (trim) from the head amp gain, allowing the FOH console and monitor console to operate their own local digital trims independently. Note that head amp gains can only be adjusted from the Setup/ preamps page and input channels with have digital trims only.

HA Remote allows console gains to be remote controlled by another console connected via AES50. This is particularly useful when operating an M32R unit as a stagebox.

card

This screen selects the input/output configuration. Use the second push encoder to select between the following presets:

- 32in / 32out
- 16in / 16out
- 32in / 8out
- 8in / 32out
- 8in / 8out
- 2in / 2out.

2.7 Monitor

Pressing the **MONITOR** button has the same effect as pressing the **VIEW** button in the **MONITOR** panel, and is covered in detail in the **MONITOR** section above.

2.8 Scenes

The **SCENES** screen on the Main Display allows setup for saving and recalling different memory scenes of the M32R. The comprehensive recallability of the console (including gain settings for the digitally-controlled mic preamps) is one of the most powerful aspects of the console.

The **SCENES** screen contains the following separate tabs:

home: This screen contains a general overview of the scenes contained in the console, along with their custom names and what parameters are included in each scene.

scenes: This screen allows the user to configure, edit and rename the individual scenes.

snippets: This screen allows for the editing of the new 'Snippets' functionality.

param safe: This screen configures which console parameters are and are not saved or switched with the console scenes.

chan safe: This screen configures which console channels are and are not changed when a console scene change occurs.

MIDI: This screen allows the console to associate different scenes with incoming and outgoing MIDI messages, allowing the console's scene changes to control or be controlled by external MIDI equipment.

HOME

The **SHOW CONTROL** screen's **home** tab shows a general overview of the Cues that have been configured in the console, along with their custom names and what parameters are included in each Cue.

A Cue is simply a single event (such as a Scene, Snippet or MIDI command) or a collection of events. These can be grouped together and stored for future recall. Up to 500 Cue entries can be stored in the M32 at any time.

For a setting where these events are used heavily and are critical (such as a theatre performance), this would be a good screen to leave on at all times so that the console operator can be completely sure what Cue the console currently resides on, and what Cue will come up next when the **GO** button is pressed.

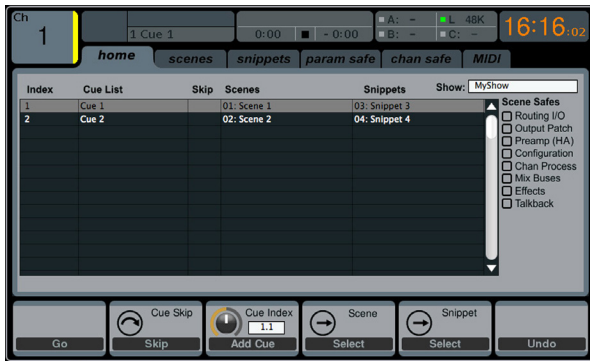

To adjust the various settings on the home tab, perform the following steps:

1. Rotate the 1st encoder to scroll among the available scenes in the scenes list, which is displayed on the left side of the color screen.
2. Tap the 1st encoder to "go" to the currently selected scene in the list, switching the console to the state it was in when that scene was stored.
3. Rotate the 2nd encoder to select a scene in the list to be "skipped" when cycling through scenes using the Prev and Next buttons.
4. Tap the 2nd encoder to complete the "skip" command on the currently selected scene. That scene will now be skipped when scrolling through the list.
5. Rotate the 3rd encoder to add a Cue to the list, and determine if it will be added as a completely new entry, or a subset of an existing cue. Tap the encoder to bring up the edit screen where the cue can be named.
6. Rotate the 4th encoder to scroll through the list of scenes and tap the encoder to select.
7. Rotate the 5th encoder to scroll through the list of snippets and tap the encoder to select.
8. Tap the 6th encoder to undo.

Utility

Pressing the **UTILITY** button to the right of the Main Display changes the bottom of the **home** tab to the following configuration:



Each of the functions on this layer can be controlled with the adjacent push encoder as follows:

Copy - Allows the user to make a copy of the currently-selected Cue.

Edit Cue - Allows the user to edit the currently-selected Cue.

Add Cue - Adds a new Cue into the current Showfile.

Delete - Deletes the currently-selected Cue.

Import Show - Imports a Showfile from a connected USB drive.

PLEASE NOTE that this will replace the existing Showfile, so this should be saved beforehand.

Export Show - Exports the current Showfile to a connected USB drive.

SCENES

Use the **Load**, **Save** and **Edit** functions by pressing the adjacent push encoder to load, save and edit the scenes. The **Scenes Safe** function works in a similar way to the **PARAMETER SAFE** function, though only applies to specific scenes.

Utility

Pressing the **UTILITY** button to the right of the Main Display changes the bottom of the **scenes** tab to the following configuration:



Each of the functions on this layer can be controlled with the adjacent push encoder as follows:

Copy - Allows the user to make a copy of the currently-selected Scene.

Paste - Pastes a Scene from the virtual clipboard.

Edit - Allows the user to edit the currently-selected Scene.

Delete - Deletes the currently-selected Scene.

Import Scenes - Imports a Scene from a connected USB drive.

Export Scenes - Exports a Scene to a connected USB drive.

SNIPPETS

The M32R has a new flexible structure called 'Snippets', which allows for setting selective parameters and channel filters for storage. Recalling a Snippet will exclusively affect the stored bits of information, leaving the remaining console status untouched. This allows to surgically introduce specific bits of automation into the current mix status. Up to 100 Snippets can be stored at any time. Use the **Load**, **Save** and **Edit** functions by pressing the adjacent push encoder to load, save and edit the Snippet.

A Snippet can be focused on any specific selection of parameters a user may find suitable, such as EQ, Insert, Fader, Mute, Send levels, etc. A Snippet will also be focused on a random selection of channels (inputs, returns or any mixes). When loading this Snippet only the previously stored information will replace the respective console parameters, while the rest remains as is.

Utility

Pressing the **UTILITY** button to the right of the Main Display changes the bottom of the *snippets* tab to the following configuration:



Each of the functions on this layer can be controlled with the adjacent push encoder as follows:

Copy - Allows the user to make a copy of the currently-selected Snippet.

Paste - Pastes a Snippet from the virtual clipboard.

Edit - Allows the user to edit the currently-selected Snippet.

Delete - Deletes the currently-selected Snippet.

Import Snippets - Imports the selected Snippet(s) from a connected USB drive.

Export Snippets - Exports the selected Snippet(s) to a connected USB drive.

PARAMETER SAFE

The **SHOW CONTROL** screen's *param safe* tab configures which of the M32R's parameters are or are not saved or switched with the console scenes. This is very useful when the operator has certain parameters of which they wish to remain in control, and would never want to have altered during a scene change, for example the mic pre gains on the input channels.

To adjust the various settings on the *param safe* tab, perform the following steps:

1. Turn any of the first four push encoders to navigate among the checkboxes on the Main Display, which represent various console areas that can be isolated from scene changes.
2. Tap any of the first four push encoders to select the console areas that have been selected with the push encoders. In each of the four columns, multiple console areas can be selected and isolated from scene changes.

The following areas of the M32R can be isolated from scene changes, and are divided up into four columns on the Main Display:

Column 1: Input Channels

- HA (Head Amp / Microphone Preamp)
- Configuration
- Channel EQ
- Channel Gate / Compressor
- Channel Insert
- Channel Groups
- Fader, Pan, Mute, Mix Ons.

Column 2: Input Channels

- Mix Sends 1-16.

Column 3: Mix Buses

- Mix Sends 1-16
- Configuration
- EQ
- Compressor
- Insert
- Groups
- Fader, Pan, Mute, Matrix Ons.

Column 4: Console

- Configuration
- Solo
- Routing
- Output Patch.

CHANNEL SAFE

The **SHOW CONTROL** screen's *chan safe* tab configures which console channels are and are not changed when a scene change occurs. This allows the user to protect certain channels from ever changing during a scene change, giving them as much control as possible for key audio sources.

For example, in a theatre context, the console operator may have dialled in just the right EQ and compressor settings, and channel volume for the voice of the lead actor, and does not want to have them altered when the console changes scenes and alters various other parameters.

To adjust the various settings on the *chan safe* tab, perform the following steps:

1. Turn any of the six push encoders to navigate among the checkboxes on the Main Display, which represent various groups of channels that can be isolated from scene changes.
2. Tap any of the six encoders to select the console areas that have been highlighted with the push encoders. In each of the six columns, multiple console areas can be selected and isolated from scene changes.

The following areas of the M32R can be isolated from scene changes, and are divided up into six columns on the Main Display:

Column 1: Channels

- Input Channels 1-16

Column 2: Channels

- Input Channels 17-21.

Column 3: Buses

- Aux 1-8
- FX 1L through 4R.

Column 4: Returns

- Mix 1-6.

Column 5: Main / Matrix / Groups

- Matrix 1-6
- LR Bus
- Centre / Mono Bus
- DCA Groups 1-8.

Column 6: Effects Slots

- FX 1-8.

MIDI

The **MIDI** tab on the **SHOW CONTROL** screen allows the console to associate different Cues with incoming and outgoing MIDI messages, allowing the console's scene changes to control or be controlled by external MIDI equipment.

For instance, the user could configure the console to issue a MIDI Program Change message as each new Cue is recalled, with the outgoing MIDI message triggering a MIDI-equipped lighting controller.

Conversely, the user could configure the console to change Cues in response to an incoming MIDI Program Change message, allowing the console to switch to a new audio scene when a new scene is recalled on a MIDI-equipped lighting controller.

To adjust the various settings on the **MIDI** tab, perform the following steps:

1. Turn the first push encoder to select a Cue to edit.
2. Turn the third push encoder to select what type of MIDI event is transmitted by the console when a scene change is issued. The choices include:
 - Off (no MIDI event)
 - MIDI Program Change
 - MIDI Control Change
 - Note.
3. Push encoders 4, 5 and 6 adjust the channel, number and value or velocity, where applicable.

The Main Display shows the MIDI data associated with the currently selected screen.

2.9 Mute Group

The M32R's **MUTE GRP** screen allows for quick control of the console's six mute groups.

When activated, the **MUTE GRP** screen only covers the bottom portion of the Main Display, allowing the middle portion to continue displaying its usual screen content.

To assign channels to one of the six mute groups, perform the following steps:

1. To assign a channel to a Mute Group, press the channel's **SEL** button to select it, then press the **HOME** button and navigate to the 'home' tab.
2. Flip to the 2nd layer of encoder controls with the down arrow key, then turn the 4th encoder to select one of the 6 Mute Groups. Press the encoder to assign.
3. After assignments have been made, press the **MUTE GRP** button to gain quick access to engaging/disengaging the mute groups.

To use the **MUTE GRP** screen to mute or unmute the groups, perform the following steps:

1. Tap any of the six push encoders to mute the corresponding group, and thus mute all channels that are assigned to that mute group.
2. Tap the encoder of a currently mute group to unmute that group.
3. When finished working with mute groups, tap the **MUTE GRP** button to exit the screen. The Main Display will again show its full set of controls for the current page.

2.10 Utility

The **UTILITY** screen is a supplemental screen designed to work in conjunction with the other screens that may be in view at any particular moment.

The **UTILITY** screen is never seen by itself; it always exists in the context of another screen.

To reinforce this point, when the **UTILITY** screen selection button is pressed, it illuminates at the same time that another screen selection button is illuminated, showing you for which screen it is providing other utilities. For most screens, pressing the **UTILITY** button simply acts as a short cut to a page that can be navigated to by other means. In a few cases, a utility page provides extra functionality not seen anywhere else.

The **UTILITY** screen selection button works in the following manner with other screens on the console:

HOME Screen

Pressing the **UTILITY** button while on any of the tabs on the **HOME** page will take the user to the **channel** tab of the **LIBRARY** screen.

METERS Screen

There are no Utility functions on any of the **METERS** screen's tabs.

ROUTING Screen

Pressing the **UTILITY** button while on any of the **ROUTING** screen's tabs takes the user to the **routing** tab of the **LIBRARY** screen.

SETUP Screen

With the exception of the **scribble strips** tab, there are no Utility functions on any of the **SETUP** screen's tabs.

For the **scribble strips** tab, pressing the **UTILITY** button provides an interface for assigning a custom colour, name and icon to the currently selected input or output channel.

- Adjust and tap the six push encoders to assign a colour, name and icon to the currently selected input or output channel. Tap the sixth encoder to save changes and exit.

LIBRARY Screen

There are no Utility functions on any of the **LIBRARY** screen's tabs.

EFFECTS Screen

Pressing the **UTILITY** button while on any of the **EFFECTS** screen's tabs takes the user directly to the **effects** tab of the **LIBRARY** screen.

RECORDER Screen

Pressing the **UTILITY** button while on either of the **RECORDER** screen's tabs takes the user directly to the **select USB drive folder/file** page of the **RECORDER** screen's **config** tab.

MONITOR Screen

There are no Utility functions on any of the **MONITOR** screen's tabs.

TALKBACK Screen

There are no Utility functions on any of the **TALKBACK** screen's tabs.

SHOW CONTROL Screen

Pressing the **UTILITY** button while on any of the **SCENES** screen's tabs provides an interface for copying, pasting, loading and saving different scenes in the scene list. Adjust and tap the six push encoders to perform these functions. More information can be found in the **SHOW CONTROL** section.

ASSIGN Screen

There are no Utility functions on any of the **ASSIGN** screen's tabs.

2.11 Internal Effects

The M32R contains over 60 internal effects that can be applied to each of the input channels, either as inserts or as sends and returns. Access the internal effects by pressing the **EFFECTS** button next to the Main Display. The functionality for each of the effects is detailed below.

Note - for information on routing channels to the FX processors, see **Chapter 2.5 Effects**.



Hall Reverb

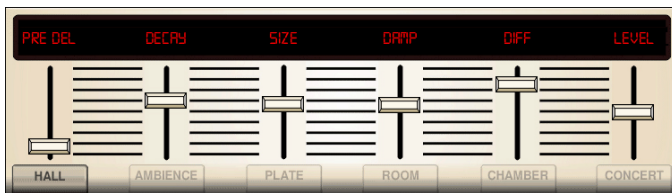

Classic Hall Reverb simulates the reverberation that occurs when sound is recorded in medium- to large-sized concert halls. Use the Hall Reverb to give your mix a lush, three-dimensional quality that will make your performance sound larger than life. *Inspired by the Lexicon Hall.*

The **PRE DELAY** slider controls the amount of time before the reverberation is heard following the source signal. **DECAY** controls the amount of time it takes for the reverb to dissipate. **SIZE** controls the perceived size of the space being created by the reverb effect. The **DAMP** slider adjusts the decay of high frequencies within the reverb tail. **DIFF** (usion) controls the initial reflection density. **SHAPE** adjusts the contour of the reverberation envelope.

LO CUT and **HI CUT** function as Low- and High-Cut filters. **BASSMUL** multiplies the bass frequencies and **MOD SPEED** adjusts the speed of the effect's modulation. **SHAPE** adjusts the contour of the reverberation envelope.

Ambience

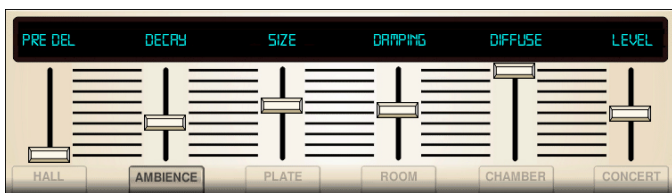

Ambience creates a customisable virtual acoustic space in which to place the elements of a mix. Use Ambience to add warmth and depth without colouring the direct sound. *Inspired by the Lexicon Ambience Algorithm.*

PRE DELAY sets the time before the reverb follows the source signal. **DECAY** adjusts the time it takes for the reverb to completely dissipate. **SIZE** controls the room size emulation. **DAMPING** controls the high-frequency decay within the reverb tail. **DIFFUSE** controls the initial echo density. The level sets the volume output of the affected signal. **LO CUT** affects the low frequency cut, allowing lower frequencies to remain unaffected by the reverb. **HI CUT** affects the high frequency cut, allowing higher frequencies to remain unaffected by the reverb. **MOD** adjusts the level of reverb decay modulation. **TAIL GAIN** adjusts the volume of the reverb tail.

Rich Plate Reverb

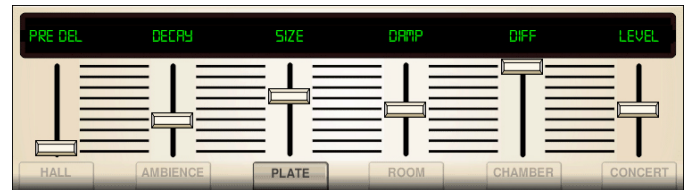

Rich Plate Reverb was originally created by sending a signal through a transducer to create vibrations on a plate of sheet metal which were then picked up as an audio signal. Our algorithm simulates that sound with high initial diffusion and a bright-coloured sound. *Inspired by the Lexicon Plate Reverb.*

The **PRE DELAY** slider controls the amount of time before the reverberation is heard following the source signal. **DECAY** controls the amount of time it takes for the reverb to dissipate. **SIZE** controls the perceived size of the space being created by the reverb effect. The **DAMP** slider adjusts the decay of high frequencies within the reverb tail. **DIFF** (usion) controls the initial reflection density.

LO CUT and **HI CUT** function as Low- and High-Cut filters. **BASSMUL** multiplies the bass frequencies and **MOD SPEED** adjusts the speed of the effect's modulation. **SHAPE** adjusts the contour of the reverberation envelope.

The **SPIN** parameter sets the amount of random modulation for the reverb tail. The parameters **Echo / EchoFeed** set the parameters of a feedback delay at the input of the reverb (independent for both input channels). **Echo** sets the delaytime and **EchoFeed** the amount of feedback (positive or negative). This allows to further increase the reflection density of the reverb.

Room Reverb

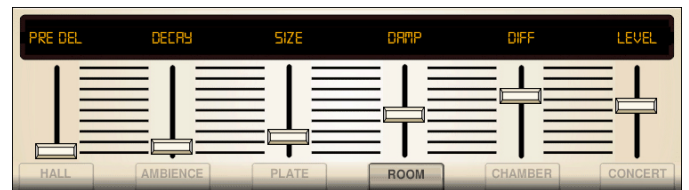

Room Reverb simulates the reverberation that occurs when sound is recorded in a small room. When you want to add a bit of warmth and just a touch of reverb, the M32's Vintage Room breathes life into close-miked guitar and drum tracks. *Inspired by the Lexicon Room Reverb.*

The **PRE DELAY** slider controls the amount of time before the reverberation is heard following the source signal. **DECAY** controls the amount of time it takes for the reverb to dissipate. **SIZE** controls the perceived size of the space being created by the reverb effect. The **DAMP** slider adjusts the decay of high frequencies within the reverb tail. **DIFF** (usion) controls the initial reflection density. **SHAPE** adjusts the contour of the reverberation envelope.

Chamber Reverb

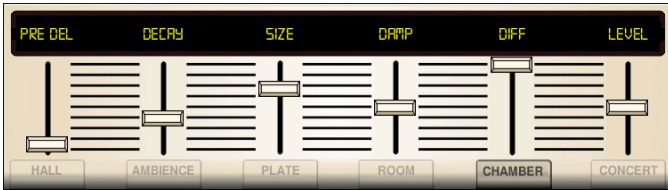

Chamber Reverb simulates the reverberation found in medium sized spaces, somewhere between the intimacy of a small room, and the grandeur of a large hall. *Inspired by the Lexicon Chamber Reverb.*

The **PRE DELAY** slider controls the amount of time before the reverberation is heard following the source signal. **DECAY** controls the amount of time it takes for the reverb to dissipate. **SIZE** controls the perceived size of the space being created by the reverb effect. The **DAMP** slider adjust the decay of high frequencies within the reverb tail. **DIFF**(usion) controls the initial reflection density. **SHAPE** adjust the contour of the reverberation envelope.

Plate Reverb



A plate reverb was originally created by sending a signal through a transducer to create vibrations on a plate of sheet metal which were then picked up as an audio signal. Our algorithm simulates that sound with high initial diffusion and a bright-coloured sound. The M32's Plate Reverb will give your tracks the sound heard on countless hit records since the late 1950s. *Inspired by the Lexicon PCM-70.*

PRE DELAY controls the amount of time before the reverberation is heard following the source signal. **DECAY** controls the amount of time it takes for the reverb to dissipate. **SIZE** adjusts the size of the virtual room created by the reverb effect. The **DAMP** push encoder adjusts the decay of high frequencies within the reverb tail. **DIFF**(usion) controls the initial reflection density. **LEVEL** controls the volume of the reverb.

The **LO CUT** push encoder sets the frequency beneath which the source signal will not pass through the reverb. The **HI CUT** push encoder sets the frequency above which the source signal will not pass through the reverb. **BASS MULT**(iplier) push encoder adjusts the decay time of the bass frequencies. **XOVER** controls the crossover point for bass. **MOD DEPTH** controls the intensity of the reverb tail modulation. **MOD SPEED** controls the speed of the reverb tail modulation.

Vintage Reverb



Based on the legendary EMT250, the M32's Vintage Reverb delivers shimmering, bright reverb that won't drown out or overpower your live or recorded tracks. Use Vintage Reverb to sweeten vocals and snare drums without sacrificing clarity.

When Layer 1 is selected, the first slider on the left sets the reverb time from 4 milliseconds to 4.5 seconds. Slider 2 controls the low-frequency multiplier decay time. Slider 3 controls the high-frequency multiplier decay time. Slider 4 controls the amount of modulation in the reverb tail. When Layer 2 is selected, slider 1 adjusts the pre-delay. Slider 2 selects the low-cut frequency. Slider 3 selects the hi-cut frequency. Slider 4 selects adjusts the output level of the reverb.

Pressing the first push encoder on Layer 1 will switch the reverb algorithm to emulate the perceived position of the reverb in the virtual space. The same control on Layer 2 will change the reverb algorithm to give a warmer, more 'vintage' sound.

Vintage Room



Vintage Room simulates the reverberation that occurs when sound is recorded in a small room. When you want to add a bit of warmth and just a touch of reverb, the M32's Vintage Room breathes life into close-miked guitar and drum tracks. *Inspired by the Quantec QRS.*

The VU meter displays the input and output levels. Set the early reflection times for the left and right channel with **ER DELAY L** and **ER DELAY R**. **ER LEVEL** sets the loudness of the early reflection level. **REV DELAY** controls the amount of time before the reverberation is heard following the source signal. **LEVEL** controls the volume of the reverb. Pressing the second push encoder will engage the **FREEZE** function which takes the incoming audio and loops it indefinitely.

HI/LO MULTIPLY adjusts the decay time of the high and bass frequencies. **DECAY** shows the duration of the reverb effect. **ROOM SIZE** adjusts the size of the room effect being created incrementally from small to large. **HIGH CUT** sets the frequency above which the source signal does not pass through the reverb. **DENSITY** manipulates the reflection density in the simulated room. (This slightly changes the reverb decay time.) **LOW CUT** sets the frequency below which the source signal does not pass through the reverb.

Gated Reverb



This effect was originally achieved by combining a reverb with a noise gate. Our gated reverb creates the same impression by a special shaping of the reverb tail. Gated Reverb is especially effective for creating a 1980's-style snare sound, or to enlarge the presence of a kick drum. *Inspired by the Lexicon 300/480L.*

PRE DELAY controls the amount of time before the reverberation is heard following the source signal. **DECAY** controls the amount of time it takes for the reverb to dissipate. **ATTACK** controls how fast the reflection density builds up. **DENSITY** shapes the reverb decay tail. The higher the density, the greater the number of sound reflections. **SPREAD** controls how the reflection is distributed through the reverb envelope. **LEVEL** controls the volume of the reverb. The **LO CUT** push encoder sets the frequency beneath which the source signal will not pass through the reverb. **HiSvFr / HiSvGn** push encoders adjust a high-shelving filter and the input of the reverb effect. **DIFF**(usion) controls the initial reflection density.

Reverse Reverb



Reverse Reverb takes the trail of a reverb, turns it around, and places it in front of the sound source. Use the swelling crescendo of the Reverse Reverb to add an ethereal quality to vocal and snare drum tracks. *Inspired by the Lexicon 300/480L.*

Adjusting the **PRE DELAY** push encoder adds up to 200 milliseconds before the reverb follows the source signal. The **DECAY** push encoder adjusts the time it takes for the reverb to completely dissipate. **RISE** controls how quickly the effect builds up. **DIFF**(usion) controls the initial reflection density. **SPREAD** controls how the reflection is distributed through the reverb envelope. The **LO CUT** push encoder sets the frequency beneath which the source signal will not pass through the reverb. **HiSvFr / HiSvGn** push encoders adjust a high-shelving filter and the input of the reverb effect.

Stereo Delay

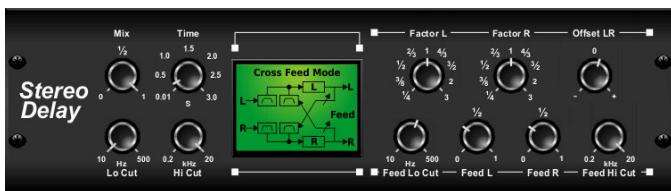

Stereo Delay provides independent control of left and right delay (echo) times, and features high- and low-pass filters for enhanced tone-shaping of the delayed signals. Use the Stereo Delay to give your mono signals a wide presence in the stereo field.

The **MIX** control lets you blend the source signal and the delayed signal. **TIME** adjusts the master delay time up to three seconds. **LO CUT** adjusts the low frequency cut, allowing lower frequencies to remain unaffected by the delay. **HI CUT** adjusts the high frequency cut, allowing higher frequencies to remain

unaffected by the delay. **FACTOR L** sets the delay time on the left channel to rhythmic fractions of the master delay time. **FACTOR R** sets the delay time on the right channel to rhythmic fractions of the master delay time. **OFFSET LR** adds a delay difference between the left and right delayed signals. The **FEED LO CUT/HI CUT** adjusts filters in the feedback paths. **FEED L** and **FEED R** control the amount of feedback for the left and right channels. **MODE** selects the feedback mode:

- **ST** sets normal feedback for both channels
- **X** crosses feedback between left and right channels
- **M** creates a mono mix within the feedback chain.

Triple Delay



Sometimes called a 3-Tap Delay, the Triple Delay provides three delay stages with independent frequency, gain and pan controls. Create time-based echo effects with the triple delay to increase the sense of stereo separation.

TIME sets the master delay time, which is also the delay time for the first stage. **GAIN BASE** sets the gain level of the first stage of the delay. **PAN BASE** sets the position of the first delay stage in the stereo field. **LO CUT** sets the frequency at which the source signal can begin passing through the delay. **HI CUT** sets the frequency at which the source signal can no longer pass through the delay. **X-FEED** indicates that stereo cross-feedback of the delayed signals is active. **MONO** activates a mono mix of both channels for the delay input. **FEEDBACK** adjusts the amount of feedback.

FACTOR A controls the amount of delay time in the second stage of the delay. **GAIN A** controls the gain in the second stage of the delay. **PAN A** sets the position of the second stage of the delay in the stereo field. **FACTOR B** controls the amount of delay time in the third stage of the delay. **GAIN B** controls the gain in the third stage of the delay. **PAN B** sets the position of the third stage of the delay in the stereo field.

Rhythm Delay

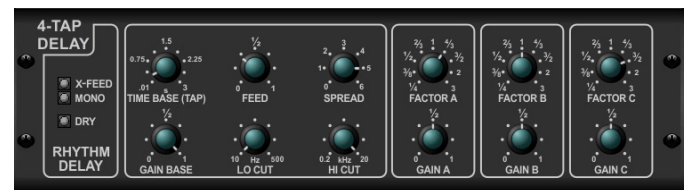

The Rhythm Delay, or 4-Tap Delay, provides four delay stages with independent frequency, gain and pan controls. Create time-based echo effects with the triple delay to increase the sense of stereo separation.

TIME sets the master delay time, which is also the delay time for the first stage. **GAIN BASE** sets the gain level of the first stage of the delay. **LO CUT** sets the frequency at which the source signal can begin passing through the delay. **HI CUT** sets the frequency at which the source signal can no longer pass through the delay. **X-FEED** indicates that stereo cross-feedback of the delayed signals is active. **MONO** activates a mono mix of both channels for the delay input. **FEEDBACK** adjusts the amount of feedback. **SPREAD** adjusts the perceived stereo placing of the echoes.

FACTOR A controls the amount of delay time in the second stage of the delay. **GAIN A** controls the gain in the second stage of the delay. **FACTOR B** controls the amount of delay time in the third stage of the delay. **GAIN B** controls the gain in the third stage of the delay. **FACTOR C** controls the amount of delay time in the fourth stage of the delay. **GAIN C** controls the gain in the fourth stage of the delay.

Stereo Chorus



Chorus samples the input, slightly detunes it and mixes it with the original signal to produce a somewhat thicker, shimmering sound. Use it to thicken up background vocals, or to double the sound of brass and woodwind instruments.

Whereas **DELAY L / R** set the total amount of delay for the left and right channels, **WIDTH L / R** determines the amount of modulated delay taken from either the left or right channels. **SPEED** sets the modulation speed, **MIX** adjusts the balance of dry and wet signals. You can further sculpt the sound by trimming some of the low- and high-end of the affected signal with the **LO CUT** and **HI CUT** push encoders. Additionally the **PHASE** push encoder can tweak the phase offset of the LFO between left and right channels, and the **SPREAD** push encoder adjusts how much of the left channel is mixed into the right, and vice versa. Finally the **WAVE** push encoder blends between the 'Danish' style digital triangular chorus sound and the classic analogue sine wave.

Stereo Flanger



The Flanger emulates the phase-shifting sound (comb-filtering) originally created by applying pressure against the flange of the reel on a tape recorder. This effect creates a unique 'wobbly' sound that is quite dramatic when used on vocals and instruments.

The controls of this effect are nearly identical to the controls on the Chorus effect block. Additionally, the **FEEDBACK** can be adjusted with positive and negative amounts, and also band-limited with the **FEED HC** (high-cut) and **FEED LC** (low cut) push encoders.

Stereo Phaser



A Stereo Phaser, or phase shaper, applies multiple **STAGES** of modulated filters to the input signal to create a 'notch' in the frequency response, and then applies a **MIX** with the original for a 'swirling' effect. Use the M32's Stereo Phaser to add a 'spaced-out' sound to vocal or instrumental tracks.

SPEED sets the LFO rate and **DEPTH** sets the LFO modulation depth. The **BASE** push encoder adjusts the frequency range of the modulation filters. The resonance is adjusted with the **RESO** push encoder. **STAGES** determines the number of times the audio signal is processed by the effect. **MIX** determines how much of the affected signal is present in the output audio.

The **WAVE** push encoder shapes the symmetry of the LFO waveform, and **PHASE** dials in an LFO phase difference between the left and right channels. The modulation source can also be the signal envelope, which produces vowel-like opening and closing tones. The **ENV MOD** push encoder adjusts how much of this effect takes place (positive and negative modulation is possible), and the **ATTACK**, **HOLD** and **RELEASE** push encoders all tailor the response of this feature.

Dimension-C

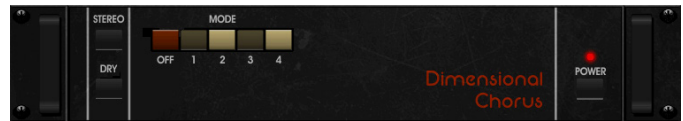

Chorus samples the input, slightly detunes it and mixes it with the original signal to produce a somewhat thicker, shimmering sound. Use it to thicken up background vocals, or to double the sound of brass and woodwind instruments. *Inspired by the Roland Dimension D.*

Turning the first push encoder to toggle the output signal between **Mono** and **Stereo**. Pressing the first encoder turns the effect on or off. Pressing the second encoder turns dry mode on or off. Pressing the third, fourth or fifth push encoders engages the chorus effect with increasing intensity.

Mood Filter



The Mood Filter uses an LFO generator and an auto-envelope generator to control a VCF (voltage-control filter), as well as a side-chain function, where the channel B signal controls the envelope of channel A. When applied to electronic instruments, the Mood Filter can be used to emulate the natural sound of acoustic instruments. *Inspired by the MiniMoog.*

This filter can be modulated with the signal's envelope using the **ENV MOD** (with positive and negative amounts), **ATTACK** and **RELEASE** push encoders, or the LFO can modulate the filter. The **WAVE** push encoder selects between seven different waveforms - triangular, sine, saw plus, saw minus, ramp, square and random. The **PHASE** can be offset by up to 180°. The **SPEED** push encoder adjusts the rate of the LFO, and **DEPTH** adjusts the amount of LFO modulation. Adjust the resonance of the filter until self-oscillation with the **RESO**(nance) push encoder. **BASE** adjusts the range of the filter from 20 Hz to 15 kHz. The **MODE** switch selects between low-pass (LP), high-pass (HP), band-pass (BP) and Notch. Use the **MIX** push encoder to blend the affected signal with the dry sound. With the **4 POLE** switch engaged there will be a steeper slope than the **2 POLE** setting. The **DRIVE** push encoder adjusts the level, and can also introduce an overdrive effect (as with real analogue filters) if pushed hard. In Side-chain mode, only the left input signal is processed and fed to both outputs. The envelope of the right input signal can be used as a modulation source. Applying the **SIDE CHAIN** function ensures that the parameters of the effect are changed based on an external stimulus signal.

Rotary Speaker



Rotary Speaker emulates the sound of a Leslie rotating speaker. The M32's Rotary Speaker provides more flexibility than its electro-mechanical counterpart, and can be used with a variety of instruments, and even vocals, to create a whirling, psychedelic effect.

The **LO SPEED** and **HI SPEED** push encoders adjust the rotation speed of the Slow and Fast speed selection, and can be toggled with the **FAST** button. The **ACCEL**(eration) push encoder adjust how quickly the speed increases and decreases from the Slow mode to the Fast mode. The rotation effect can also be disengaged with the **STOP** button, which will stop the movement of the speakers.

DISTANCE adjust the perceived distance between the speakers and the virtual microphone. **BALANCE** sweeps between low and high frequencies in the output signal. **MIX** determines how much of the affected signal is present in the output audio.

Tremolo / Panner

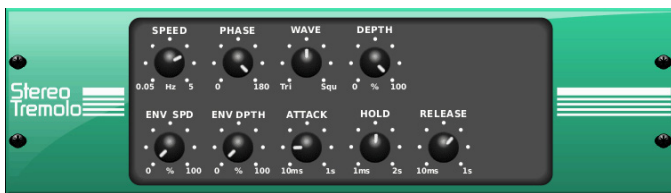

Stereo Tremolo creates an up and down volume change at a constant and even tempo just like the guitar amps of yesteryear. Use the M32's Stereo Tremolo to add a unique 'surf-music' texture to a vocal or instrumental track.

SPEED adjusts the LFO rate, and **DEPTH** sets the amount of modulation. **PHASE** can be used to set an LFO phase difference between the left and right channels, which can be used for panning effects. The **WAVE** push encoder blends the LFO waveform between triangular and square shapes. The signal envelope, shaped by **ATTACK**, **HOLD** and **RELEASE**, can be used to modulate the LFO speed (**ENV SPD**) and the LFO modulation depth (**ENV DPTH**).

Suboctaver



The Octave Effect combines the input signal with a digitally synthesised sound one or two octaves below the original signal. This can be used to thicken up guitar sounds, or to add extra 'punch' to kick drums.

The controls for the Suboctaver are split between two discreet layers. Pressing the first push encoder toggles the effect for each layer on or off. The second encoder increases the amount of the affected signal that is present in the output mix. The third encoder switches the range of the signal between **LO**, **MID** and **HI**. The fourth and fifth encoders adjust the level for each of the individual lower octaves. To navigate between the two layers, use the up and down navigational controls.

Delay + Chamber



Here we have combined Delay and Chamber reverb, so that a single device can supply a variety of delay settings, plus add just the right amount of reverb to the selected signal. This device only uses one effects slot. *Inspired by the Lexicon PCM 70.*

Use the **BALANCE** push encoder to adjust the ration between delay and reverb. Low frequencies can be excluded with the **LO CUT** push encoder, and **MIX** adjust how much of the effect is added to the output signal. The **TIME** push encoder adjusts the delay time for the left channel delay, and **PATTERN** sets the delay ratio for the right channel delay. Adjust the **FEEDBACK** and trim some high frequencies with the **FEED HC** (high-cut) push encoder. The **XFEED** push encoder allows you to send the delay sound to the reverb effect, so instead of running completely parallel, the reverb affects the echoes to a selected degree. The **PREDELAY** push encoder determines the delay before the reverb affects the signal. The **DECAY** push encoder adjusts how quickly the reverb fades. **SIZE** controls how large or small the simulated space (room, cathedral, etc.). The **DAMPING** push encoder determines the decay of high frequencies within the reverb tail.

Chorus + Chamber



Taking up only one FX slot, the Chorus + Chamber effect combines the shimmer and doubling characteristics of a studio-grade chorus with the sweet sound of a traditional chamber reverb. *Inspired by the Lexicon PCM 70.*

The **BALANCE** push encoder adjusts the balance between chorus and reverb. Low frequencies can be excluded with the **LO CUT** push encoder, and the **MIX** push encoder adjusts how much of the effect is added to the signal. **SPEED**, **DELAY** and **DEPTH** adjust the rate, delay and modulation depth of the chorus. The LFO **PHASE** between the left and right channels can be offset by up to 180°, and **WAVE** adjusts the LFO waveform from a sine wave to a triangular wave. The **PREDELAY** push encoder determines the delay before the reverb affects the signal. The **DECAY** push encoder adjusts how quickly the reverb fades. **SIZE** controls the size of the simulated space (room, cathedral, etc.). The **DAMPING** push encoder determines the decay of high frequencies within the reverb tail.

Flanger + Chamber



Add the mind-bending, filter-sweeping effect of a state-of-the-art flanger to the elegant sweetening of a traditional chamber reverb - all in one FX slot. *Inspired by the Lexicon PCM 70.*

The **BALANCE** push encoder adjusts the balance between flanger and reverb. Low frequencies can be excluded with the **LO CUT** push encoder, and the **MIX** push encoder adjusts how much of the effect is added to the signal. **SPEED**, **DEPTH** and **DELAY** adjust the rate, delay and modulation depth of the flanger. **FEEDBACK** can be adjusted by positive and negative amounts. The **LFO PHASE** between the left and right channels can be offset by up to 180°. The **PREDELAY** push encoder determines the delay before the reverb affects the signal. The **DECAY** push encoder adjusts how quickly the reverb fades. **SIZE** controls the size of the simulated space (room, cathedral, etc.). The **DAMPING** push encoder determines the decay of high frequencies within the reverb tail.

Delay + Chorus



This combination effect merges a user-definable delay (echo) with a studio-quality chorus, sure to fatten up even the skinniest track. Uses only one FX slot. *Inspired by the TC Electronic D-Two.*

The **TIME** push encoder adjusts the delay time, and the **PATTERN** push encoder sets the delay ratio for the right channel and negative values activate a cross feedback between the two channels. The **FEEDHC** push encoder adjusts the delay high-cut frequency, while **FEEDBACK** adjusts the number of repeats. The **X-FEED** control allows you to send the delay sound to the chorus effect. The **BALANCE** push encoder adjusts the ratio between delay and chorus. **SPEED**, **DEPTH** and **DEPTH** adjust the rate, delay and modulation depth of the chorus. The right channel LFO **PHASE** can be offset by up to 180°, and **WAVE** adjusts the chorus character by shaping the LFO waveform from sine wave to triangular wave. Use the **MIX** push encoder to blend the affected signal with the dry sound.

Delay + Flanger



This handy dynamic duo blends the 'whoosh' of soaring jet planes with classic delay, and can be adjusted from mild to wild. This combination effect only takes up one FX slot. *Inspired by the TC Electronic D-Two.*

The **TIME** push encoder adjusts the delay time, and the **PATTERN** push encoder sets the delay ratio for the right channel and negative values activate a cross feedback between the two channels. The **FEEDHC** push encoder adjusts the delay high-cut frequency, while **FEEDBACK** adjusts the number of repeats. The **X-FEED** control allows you to send the delay sound to the chorus effect. The **BALANCE** push encoder adjusts the ratio between delay and chorus. **SPEED**, **DEPTH** and **DEPTH** adjust the rate, delay and modulation depth of the chorus. The right channel LFO **PHASE** can be offset by up to 180°, and **FEED** (positive and negative amounts) adjusts the feedback effect. Use the **MIX** push encoder to blend the affected signal with the dry sound.

Modulation Delay



Combining echo and chorus (and in this case, reverb too) is the domain of the Modulation Delay. By combining the two, you can get the best of both worlds in one, dreamy-sounding effect.

The controls are separated onto two layers; layer one for the delay, and layer two for the chorus. Use **Balance** to sweep between how much of either effect is present in the output signal. Navigate to layer two by using the navigational control buttons. Use the **PAR / SER** function to switch between Parallel and Serial modes. In Parallel mode the input signal is routed both to the modulated delay and the reverb inputs. In Serial mode the modulated delay output is routed to the reverb input. (When balance is set to -100 there is no audible difference between the two modes since in this case only the modulated reverb is audible.)

On layer one **Time** adjusts the time of the delay, whereas **Feed** controls how many echoes follow the input signal. **Lo Cut** and **Hi Cut** are, as the names suggest, low cut and high cut filters for the affected signal. On both, **Mix** dictates how much of the affected signal is sent to the output bus.

On layer two **Depth** controls the depth of the chorus effect, **Rate** controls the speed of the modulation, and **Decay** controls the length of time after the initial signal where the effect is present. **Damping** reduces the level of the higher frequencies in the output.

The type of reverb can be switched by pressing either the third, fourth or fifth push encoders.

Dual Graphic EQ / Stereo Graphic EQ / Dual TruEQ / Stereo TruEQ



There are four standard graphic EQs that provide 31 bands of adjustment between 20 Hz and 20 kHz. A master volume slider compensates for changes in volume caused by the EQ. A maximum boost or cut of 15 dB is available for each band.

The TruEQ incorporates a special algorithm that compensates for the gain adjustment overlapping effect that adjacent frequency bands have on one another. On a standard EQ, when neighbouring bands are boosted together, the resulting effect is magnified beyond what is visible from the positioning of the sliders.

This compensated EQ will produce an adjustment that is identical to the actual positioning of the sliders.

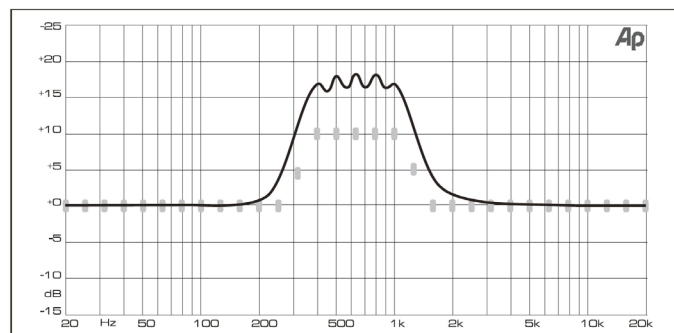

Graphic EQ without frequency response correction.

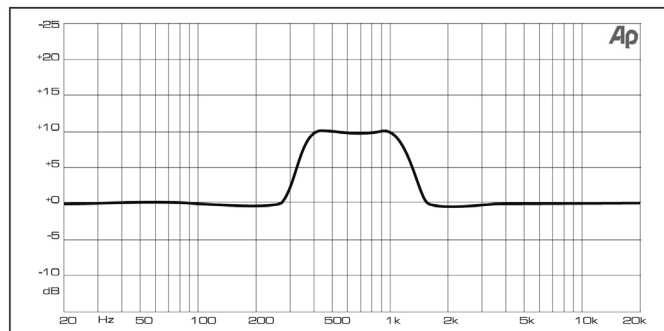

Graphic EQ with frequency response correction.

Dual DeEsser / Stereo DeEsser



De-essing is an audio effect designed to reduce the amount of excessive sibilance in an audio signal, usually when dealing with the human voice. The Dual DeEsser accurately and seamlessly removes sibilance from audio tracks.

The **Lo-Band** and **Hi-Band** controls select which portion of the audio spectrum is affected by the DeEsser on each channel. By increasing the amount of reduction, the level to which the de-essing affects the input signal can be controlled. By pressing the first and third push encoders, the effect can be targeted specifically at male or female voices.

With the Stereo DeEsser, toggle between Stereo and M/S modes by pressing the fifth push encoder.

Stereo Xtec EQ1 / Dual Xtec EQ1



Virtually indescribable, recording engineers claim this vintage EQ to be the “secret sauce” of sound enhancement. We analysed this classic to the core and created an exact physical model that reproduces the multi-faceted sound in painstaking detail. Even the transformers and tube output stage have been faithfully modelled. *Inspired by Pultec EQP-1a.*

LO FREQ determines the curve on which the left hand **LO BOOST** and **LO ATT** controls are effective. These controls can be used to either boost or attenuate the signal as required. **HI FREQ**, **HI BOOST** and **HI ATT** perform the same function, but for the higher frequencies. **HI BANDWIDTH** adjusts the width of the high-frequency boost curves.

Stereo Xtec EQ5 / Dual Xtec EQ5



By digitally “rebuilding” every aspect of this classic EQ, we captured the very essence in our parametric equaliser XTEC EQ5. Our digital re-incarnation is based on the original model and authentically emulates the smooth character of the its rather unique components. *Inspired by Pultec MEQ5.*

LO FREQ, **MID FREQ** and **HI FREQ** all dictate at which frequencies the **LO BOOST**, **MID CUT** and **HI BOOST** push encoders work.

For all of the Xtec EQs, the **TRANSFORMER** function can be engaged to switch the Transformer emulation on or off, giving a warmer sound. **GAIN** determines how much of the source signal passes through the effect, and **ACTIVE** toggles the EQ in or out of the signal path.

Wave Designer



Wave Designer is a powerful tool for adjusting signal transients and dynamics such as attack and sustain. Use it to make a snare drum really crack in the mix, or level out volume inconsistencies of slap bass tracks. *Inspired by the SPL Transient Designer.*

Adjusting the **ATTACK** push encoder can add punch or tame overly-dynamic signals. Increasing **SUSTAIN** acts in a similar way to a compressor, allowing the peaks to carry longer before decaying. The effect can also be used to reduce the sustain for a more staccato sound. The **GAIN** push encoder compensates for level changes caused by the effect.

Precision Limiter

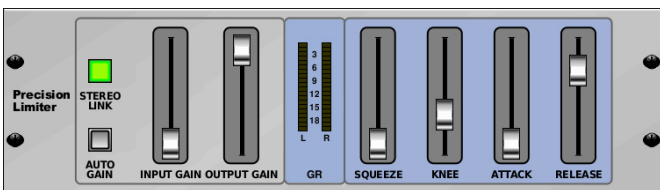

This Stereo Precision Limiter allows you to set a precise volume limit, ensuring distortion-free, optimal signal integrity. Use the M32's Stereo Precision Limiter to boost quiet signals or prevent clipping while preserving the level of ‘hot’ signals.

AUTOGAIN activates an additional long-term gain correction, allowing automatic gain scaling of varying input level ranges. **STEREO LINK** applies limiting to both channels equally when activated. **INPUT GAIN** provides up to 18 dB of gain to the input signal prior to limiting. **OUTPUT GAIN** set the final gain

level of the processed signal. **SQUEEZE** adds compression to the signal to add punch and a slight distortion depending on the amount you dial in. **ATTACK** sets the attack time, ranging from 0.05 ms to 1 ms. **RELEASE** adjusts the release time from 0.05 ms to 1.04 seconds. **KNEE** adjusts the soft limiting threshold point from hard limiting (0 dB) to maximum soft limiting (10 dB).

Stereo Combinator / Dual Combinator



The Combinator is an amazing five-band compressor that emulates famous broadcasting and mastering compressors. A highly complex processor, the Combinator utilises automatic parameter control that produces stunning and “inaudible” results.

Makeup-gain for each frequency band will automatically be adjusted by the Spectral Balance Control (SBC) function, to maintain a balanced audio spectrum.

On the first layer, **Mix** adjusts the overall effect on the input signal (100% equals full compression) and **Active** enables or bypasses the effect. **Attack/Release** adjusts the envelope times for the compressors of all five bands. **Auto** sets program dependent release times (Release time value is ignored). **SBC On** activates ‘Spectral Balance Control’ which dynamically keeps the gain of all bands in balance (auto Make-up gain adjustment). **SBC Speed** sets the speed of the correction.

X-Over adjusts the boundary frequencies of the five frequency bands. Negative values result in more ‘resolution’ in the lower frequencies and positive values increase resolution in the upper frequencies. The slope or steepness of the band separation filters can be adjusted between 12 dB and 48 dB. **Ratio** sets the compression Ratio for all five bands (1.1 – 10, Limiter). **SBC Meter** switches between SBC gain correction and compressor gain reduction displays.

On layer two, **Threshold** adds a relative offset threshold to all individual band thresholds. This allows adjusting compression amount for all bands simultaneously. **Gain** adjusts overall output gain. **Peak Meter** toggles between compressor peak reduction and band peak-meter displays. **Band Sel** selects one out of the five frequency bands, and **Band Solo** allows listening to the selected band (with the other four bands mute). **Band Thr** and **Band Gain** adjust the threshold and makeup-gain of the selected band. **Band Lock** disables compression for the selected band. Pressing the **Band Reset** encoder will disable **Band Lock** and reset **Band Thr** and **Band Gain** to zero for the selected band. Note that this is not dependant on **Band Solo** and neither is Solo mode affected by **Band Reset**.

Fair Comp / M/S Fair Comp / Dual Fair Comp



This classic tube compressor not only achieves record bids in high-end vintage gear auctions, it also delivers some of the finest colourations in compressor history. Two small trim VRs preset the control side chain action, a six-step switch determines the timing, and the two large Input and Threshold knobs adjust the levels. Our FAIR COMPRESSOR model is true to the original signal path, and conveniently provides models for dual, stereo-linked or M/S operation. *Inspired by Fairchild 670.*

INPUT GAIN determines how much of the input signal passes through the effect. **ACTIVE** toggles the effect in or out of the signal path. **THRESHOLD** determines how loud the signal has to be before compression is applied. **TIME** switches the compression's release time. **BIAS** changes the simulated tube bias algorithm. **OUTPUT GAIN** affects the gain of the output signal.

Stereo Leisure Comp / Dual Leisure Comp



The immaculate tube signal path in this Levelling Amplifier has left its exceptional clarity, its rich and warm compression on countless albums of the past decades. The ultra-smooth optical attenuator is closely modelled in our LA COMPRESSOR. It provides breezing, natural and effortlessly musical compression. *Inspired by Teletronix LA-2A.*

GAIN determines how much of the input signal passes through the effect. **ACTIVE** toggles the effect in or out of the signal path. **COMP/LIMIT** determines whether the effect acts as a compressor or a limiter. **OUTPUT GAIN** affects the gain of the output signal. Increasing **PEAK REDUCTION** means that only the signal peaks are reduced in level.

Stereo Ultimo Comp / Dual Ultimo Comp

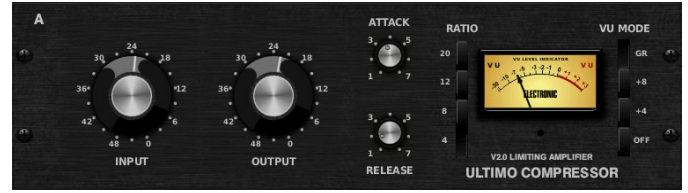

This classic compressor was one of the first audio processors to use Field Effect Transistors. Our digital reincarnation, ULTIMO COMPRESSOR, is based on the early Rev. E model and authentically captures the smooth character of the original class-A output stage and its FET's legendary Fast Attack. *Inspired by Urei 1176LN.*

INPUT GAIN, OUT GAIN, ATTACK, RELEASE and **RATIO** all work as per standard compressor functions. With the Dual Compressor, functions for each of the channels are split between Layers 1 and 2.

Dual Enhancer / Stereo Enhancer



The M32's Enhancers are so called 'Psycho EQs'. They can enhance the signal spectrum in bass, midrange and high frequencies, but they differ from traditional EQs. When you need to generate maximum punch, clarity and detail, without turning up the overall volume, our enhancers are the solution. *Inspired by the SPL Vitalizer.*

Adjust the **BASS, MID** and **HI GAIN** push encoders to add or reduce content in those spectrums. The **BASS** and **HI FREQ**(uencies) can be specifically selected, while the **MID Q** (bandwidth) can be adjusted instead. The **OUT GAIN** push encoder compensates for changes in level resulting from the effect, and **SPREAD** (stereo version only) emphasises the stereo content for a wider mix. Engage the **SOLO MODE** to isolate only the audio resulting from the effect so you can hear exactly what you're adding to the mix.

Dual Exciter / Stereo Exciter

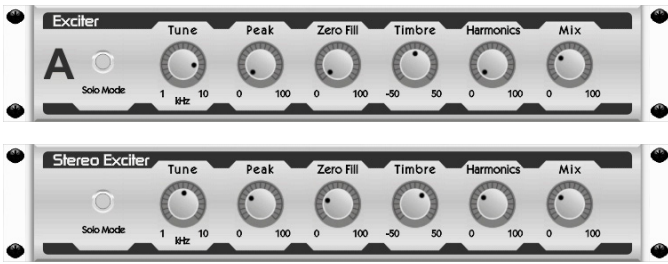

Exciters increase presence and intelligibility in live sound applications, and are indispensable for adding clarity, air and harmonic overtones in the recording studio. This effect is particularly useful for filling out the sound in difficult rooms, and for producing a more natural live or recorded sound. *Inspired by the famous Aphex Aural Exciter.*

Set the frequency of the side-chain filter with the **TUNE** push encoder, and further shape the filter slope with the **PEAK** and **ZERO FILL** controls. Turning the **TIMBRE** push encoder left of centre adds more odd harmonics, while turning it right of centre adds more even harmonics. Adjust the harmonic content added to the signal with the **HARMONICS** push encoder, and blend in the affected signal with the **MIX** push encoder. Engage the **SOLO MODE** to isolate only the audio resulting from the effect so you can hear exactly what you're adding to the mix.

Stereo Imager



A Stereo Imager is typically used to control the placement of a signal within the stereo field during mixdown or mastering. The M32's Stereo Imager will lend a professional quality to your live and recorded performances.

The **BALANCE** push encoder allows you to emphasise the mono and stereo components of the input signal. The mono and stereo signals can be panned independently with the **MONO PAN** and **STEREO PAN** controls. **OUT GAIN** is used to compensate for level changes resulting from the effect. The phase can also be shifted using the shelving push encoders. Select the frequency and bandwidth (Q) using the corresponding push encoders, then adjust the gain with **SHV GAIN**.

Edison EX1



The Edison EX1 is an unbelievably powerful psycho-acoustic processor, which allows you to completely manipulate all spatial parameters of the stereo image – such as width and depth – in a way never before possible. You can widen or narrow the stereo spread, bring instruments to the front or move them to the background, and make corrections to the stereo image – even on a finished master. *Inspired by the Behringer Edison EX1.*

St Spread increases the perceived width of the audio field over which the signal is present. **Balance** simply adjusts the levels between the left and right channels, and **Center Dist** moves the audio source back and forth in the perceived audio field. **LMF Spread** further adjusts the stereo depth by increasing or decreasing the perceived spaciousness of the output signal.

Sound Maxer



The **SOUND MAXER** restores natural brilliance and clarity to any audio signal by adjusting the phase and amplitude integrity to reveal more of the natural texture of the sound, which is often hidden when using some effects and equalisers. *Inspired by Sonic Maximizer 482i.*

Use **LO CONTOUR** to determine the curve on which the **PROCESS** control is effective. **GAIN** determines how much of the input signal passes through the effect. Selecting either of the **ACTIVE** functions activates the effect for either of the two stages.

Dual Guitar Amp / Stereo Guitar Amp

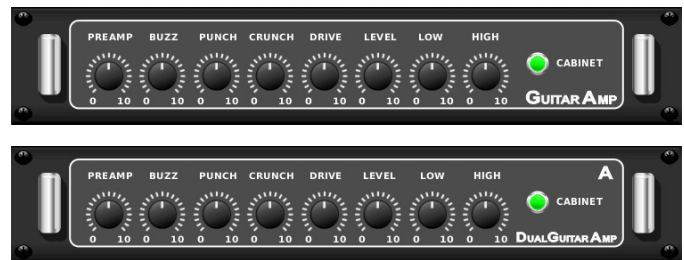

Modelled after the Tech 21 SansAmp, the Stereo / Dual Guitar Amp simulates the sound of plugging into a real guitar amp. From shimmering cleans to saturated crunch, the M32's Stereo / Dual Guitar Amp allows an electric guitar player to sound great without using an amp on stage.

The **PREAMP** push encoder adjusts the amount of input gain prior to the band-specific distortion adjustment. **BUZZ** adjusts the low-end breakup, **PUNCH** adjusts the midrange distortion, and **CRUNCH** tailors the high-frequency content and distortion for smooth or cutting notes. The **DRIVE** push encoder simulates the amount of power amp distortion from a tube amp. The **LOW** and **HIGH** push encoders allow EQ adjustment independent of distortion content, and the overall output is controlled by the **LEVEL** push encoder. The **CABINET** simulation can be bypassed if the guitarist is already using a real cabinet, which allows the effect to function like a boost or distortion pedal. The Dual Guitar Amp allows the left and right channels to be adjusted independently.

Dual Tube Stage / Stereo Tube Stage



Tube Stage / Overdrive is a versatile effect capable of emulating a variety of modern and classic tube amps. Available in stereo and dual-mono versions, use Tube Stage / Overdrive to dial in warm and fuzzy sounds from subtle to fully-saturated.

DRIVE adjusts the amount of harmonics being driven by the effect. **EVEN** and **ODD** adjusts the amount of even and odd harmonics. **GAIN** adjusts the output gain of the effect. **LO CUT** sets the input frequency below which the source signal will not pass through the effect. **HI CUT** sets the input frequency above which the signal will not pass through the effect. **BASS GAIN/FREQ** adjusts a low-shelving filter at the output of the effect. **TREBLE GAIN/FREQ** adjusts a high-shelving filter at the effect's output.

Dual Pitch Shifter / Stereo Pitch



Pitch shifting is often used in two different ways; one is to set the **MIX** control lower and only use the **CENT** control to make a small offset in pitch between the wet and dry tones. This results in a 'voice doubling' effect that thickens the overall sound in a more subtle way. The extreme use of this effect is to turn the **MIX** control fully-clockwise so that the full sound is affected. This way, the signal can be shifted into other keys up to an octave above or below the original key. When used on a voice, it results in a 'chipmunk' sound or a low, 'Darth Vader' effect.

When the **SEMI** and **CENT** push encoders are set to 12:00, the pitch is not altered. Making adjustments by semitone will have a very pronounced effect, whereas changes to the **CENT** control will be very minor. The **DELAY** control creates a time difference between the wet and dry sounds. The **LO CUT** and **HI CUT** push encoders allows the affected signal to be band-limited. The Dual-Pitch effect allows the left and right channels to be adjusted independently, and allows gain compensation and panning of the two channels.

3. Rear Panel

3.1 MONITOR / CONTROL ROOM OUT



- 1 **Talkback Microphone Input**
Connect a talkback mic via standard XLR cable.
- 2 **BAL / UNBAL Left & Right Jack Sockets**
Connect a pair of studio monitors using standard 1/4" cables.

3.2 AC / POWER

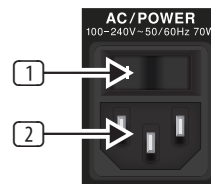

- 1 **Power On / Off**
Turn the console on and off with the On / Off switch.
- 2 **IEC Power Socket**
Connect the console to a mains power supply via the standard IEC power socket.

3.3 XLR OUT 1-8

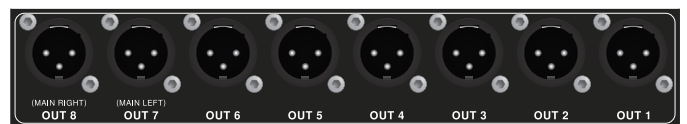

Outputs 1-8

Send audio to external equipment using XLR cables. Outputs 7 and 8 by default carry the main stereo bus signals.

3.4 XLR IN 1-16

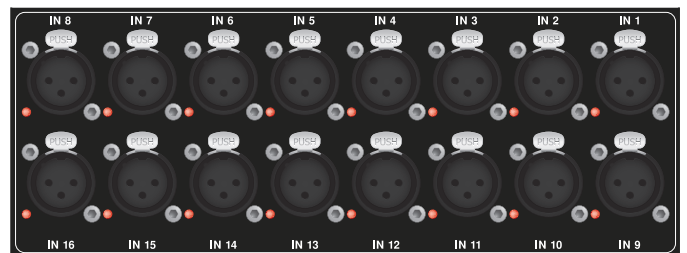

Inputs 1-16

Connect audio sources via XLR cables.

3.5 Klark Teknik DN32-USB

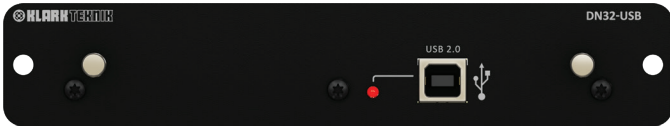

DN32 USB

Transmit up to 32 channels of audio to and from a computer using the DN32 USB audio interface.

3.6 REMOTE CONTROL



ETHERNET

Connect to a PC for remote control operation via Ethernet. See chapter 2.6 Setup - Network for wireless connection details.

3.7 MIDI



MIDI IN / OUT

Send and receive MIDI information via standard 5-pin DIN cables.

3.8 ULTRANET



Connect to a personal monitoring system (e.g. the Behringer P16) via Ethernet cable.

3.9 AES50

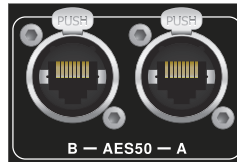

Transmit up to 96 channels in and out via Ethernet cables.

3.10 AUX IN / OUT

Connect to and from external equipment via 1/4" or RCA cables.

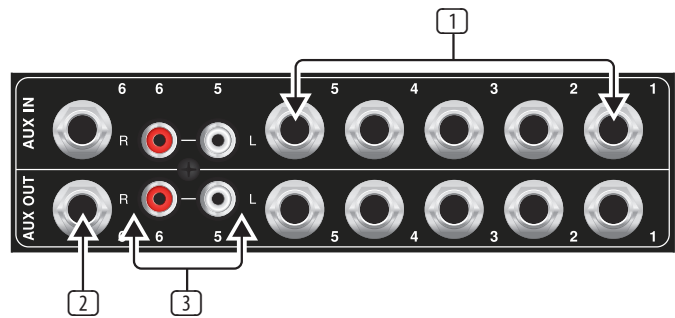

- 1 AUX In / Out 1-5
- 2 Phono In / Out 5-6
- 3 AUX In / Out 6

4. Appendices

4.1 Appendix A: Technical Specifications

Processing

Input Processing Channels	32 Input Channels, 8 Aux Channels, 8 FX Return Channels
Output Processing Channels	8 / 16
16 aux buses, 6 matrices, main LRC	100
Internal Effects Engines (True Stereo / Mono)	8 / 16
Internal Show Automation (structured Cues / Snippets)	500 / 100
Internal Total Recall Scenes (incl. Preamplifiers and Faders)	100
Signal Processing	40-Bit Floating Point
A/D Conversion (8-channel, 96 kHz ready)	24-Bit, 114 dB Dynamic Range, A-weighted*
D/A Conversion (stereo, 96 kHz ready)	24-Bit, 120 dB Dynamic Range, A-weighted*
I/O Latency (Console Input to Output)	0.8 ms
Network Latency (Stage Box In > Console > Stage Box Out)	1.1 ms

Connectors

Midas PRO Series Microphone Preamplifier (XLR)	16
Talkback Microphone Input (XLR)	1
RCA Inputs / Outputs	2 / 2
XLR Outputs	8
Monitoring Outputs (XLR / ¼" TRS Balanced)	2/2
Aux Inputs/Outputs (¼" TRS Balanced)	6 / 6
Phones Output (¼" TRS)	1 (Stereo)
AES50 Ports (Klark Teknik SuperMAC)	2
Expansion Card Interface	32 Channel Audio Input / Output
ULTRANET P-16 Connector (No Power Supplied)	1
MIDI Inputs / Outputs	1 / 1
USB Type A (Audio and Data Import / Export)	1
USB Type B, rear panel, for remote control	1
Ethernet, RJ45, rear panel, for remote control	1

Mic Input Characteristics

Design	Midas PRO Series
THD+N (0 dB gain, 0 dBu output)	< 0.01% unweighted
THD+N (+40 dB gain, 0 dBu to +20 dBu output)	< 0.03% unweighted
Input Impedance (Unbalanced / Balanced)	10 kΩ / 10 kΩ
Non-Clip Maximum Input Level	+23 dBu
Phantom Power (Switchable per Input)	+48 V
Equivalent Input Noise @ +45 dB gain (150 Ω source)	-125 dBu 22 Hz-22 kHz, unweighted
CMRR @ Unity Gain (Typical)	> 70 dB
CMRR @ 40 dB Gain (Typical)	> 90 dB

Input/Output Characteristics

Frequency Response @ 48 kHz Sample Rate	0 dB to -1 dB 20 Hz – 20 kHz
Dynamic Range, Analogue In to Analogue Out	106 dB 22 Hz - 22 kHz, unweighted
A/D Dynamic Range, Preamplifier and Converter (Typical)	109 dB 22 Hz - 22 kHz, unweighted
D/A Dynamic Range, Converter and Output (Typical)	109 dB 22 Hz - 22 kHz, unweighted
Crosstalk Rejection @ 1 kHz, Adjacent Channels	100 dB
Output level, XLR Connectors (Nominal / Maximum)	+4 dBu / +21 dBu
Output Impedance, XLR Connectors (Unbalanced / Balanced)	50 Ω / 50 Ω
Input impedance, TRS Connectors (Unbalanced / Balanced)	20 kΩ / 40 kΩ
Non-Clip Maximum Input Level, TRS Connectors	+21 dBu
Output Level, TRS (Nominal / Maximum)	+4 dBu / +21 dBu
Output Impedance, TRS (Unbalanced / Balanced)	50 Ω / 50 Ω
Phones Output Impedance / Maximum output Level	40 Ω / +21 dBu (Stereo)
Residual Noise Level, Out 1-16 XLR Connectors, Unity Gain	-85 dBu 22 Hz-22 kHz, unweighted
Residual Noise Level, Out 1-16 XLR Connectors, Muted	-88 dBu 22 Hz-22 kHz, unweighted
Residual Noise Level, TRS and Monitor out XLR Connectors	-83 dBu 22 Hz-22 kHz, unweighted

Display

Main Screen	5" TFT LCD, 800 x 480 Resolution, 262k Colours
Channel LCD Screen	128 x 64 LCD with RGB Colour Backlight
Main Meter	18 Segment (-45 dB to Clip)

Power

Switch-Mode Power Supply	Auto-Ranging 100-240 VAC (50/60 Hz) \pm 10%
Power Consumption	70 W

Physical

Standard Operating Temperature Range	5°C – 40°C (41°F – 104°F)
Dimensions	478 x 617 x 208 mm (18.8 x 24.3 x 8.2")
Weight	14.3 kg (31.5 lbs)

* A-weighted figures are typically \sim 3 dB better

4.2 Appendix B: MIDI Operation**MIDI RX > Scenes**

Whenever Program Change messages in the range 1-100 are received on MIDI CH01, the corresponding scene of the M32R internal show memory will be loaded.

This requires the following preconditions:

SETUP / remote

- MIDI In/Out check marks must be set according to the connection on which MIDI input will be accepted (via physical MIDI connectors on M32 or S16, or via DN32-USB card)
- MIDI In/Out check mark must be set for "Enable MIDI Scene Recall".

SETUP / global

- When tick mark "Confirm Pop-Ups" / "Scene Load" is active, MIDI scene recalls will only become active after manual confirmation
- If you prefer activating scenes via MIDI Program Changes immediately, un-check the "Confirm Pop-Ups" / "Scene Load" tick mark.

SHOW CONTROL VIEW / home

- Valid scenes must be stored in the internal M32R show file. It is not possible to recall empty scenes
- The scope of changes applied by a MIDI scene recall depends on the Scene Safes, Parameter Safes and Channel Safes settings, same as with recalling the scene locally.

MIDI TX > Scenes

Every scene can be assigned one specific MIDI command/event. Each time the scene is loaded the MIDI command will be sent out once. Possible choices for MIDI commands/events to be found on Scenes View/MIDI page:

- Off > no message will be sent upon scene load
- Program Change > select the MIDI Channel and the Program Number (using knobs 4/5 at the main display)
- Control Change > select the MIDI Channel, Controller number and value (using knobs 4-6 at the main display)
- Note > select the MIDI Channel, Note number and velocity (using knobs 4-6 at the main display).

Will send out a Note On command directly followed by the same Note Off command.

Permanent MIDI Assignments Overview (Remote Off)

MIDI RX	MIDI Ch	Controller	Value	Comment
Scenes	1	Program Change	1-100	
Snippet	2	Program Change	1-100	
Cue	3-6	Program Change	0-127	Ch3 -> Cue 1-127, Ch4 -> Cue 128-255, etc.
Mute Groups	2	CC80-85	on (127) / off (0), toggle latching	
Faders	1	CC0-79	0-127	Value 95 = 0dB
Mute	2	CC0-79	on (127) / off (0), toggle latching	
Pan	2	CC0-79	0-127	Value 64 = Pan Mid

MIDI TX	MIDI Ch	Controller	Value	Comment
Mute Groups	2	CC80-85	on (127) / off (0), toggle latching	
Faders	1	CC80-79	0-127	Value 95 = 0dB
Mute	2	CC80-79	on (127) / off (0), toggle latching	
Pan	3	CC80-79	0-127	Value 64 = Pan Mid

MIDI RX > Assign

Whenever assignable controls are set up for transmitting MIDI commands, reception of that same command (status or continuous) will be reflected on the respective assignable control element (button light, encoder LED collar).

MIDI TX > Assign

The assignable MIDI commands have been restricted to some generic elements: Encoders 1-4 > can be assigned to sending control changes, program changes or notes.

- Parameters are currently 'Channel' and 'Value'
- For CC and Note commands 'Value' = controller number/note number, and the encoder rotation determines the controller value/note-on velocity
- For Program Changes only the channel is specified, and the encoder rotation determines the program number

Buttons 5-12 > can be operated in two modes, 'MIDI Push' (non-latching) for momentary commands, or 'MIDI Toggle' (latching) for static commands.

MIDI Push

Can be assigned to sending control changes, program changes or notes

Parameters are currently 'Channel' and 'Value'

For CC and Note commands 'Value' 0..127 = controller number/note number, and the button momentarily toggles the controller value/note-on velocity

To 127 (depressed/released]

For Program Changes 'Value' 0..127 = program/preset number, that will be sent upon pressing the button.

MIDI Toggle

Can be assigned to sending control changes or notes

Parameters are currently 'Channel' and 'Value'

For CC and Note commands 'Value' 0..127 = controller number/note number, and the button toggles the controller value/note-on velocity

Between value/velocity 127 and 0 with every operation.

PLEASE NOTE:

The ASSIGN section also reflects/displays reception of the same MIDI commands that are selected for transmission

The MIDI commands assigned to the ASSIGN controls can be transferred to and from stage via AES50 using the S16 stage box MIDI I/O.

MIDI RX/TX > Remote

Enables a specific form of bi-directional MIDI communication for remote controlling a computer DAW application using control elements of the M32 console. REMOTE can be used in three modes, Mackie Control, HUI and raw MIDI CC (raw) controllers (see *SETUP / remote*)

MIDI CC (raw) selected and Remote is enabled+active, the group section controls will transmit/receive the following messages:

MIDI RX	MIDI Ch	Controller	Comment
Group 1-8 SELECT	1	Note 64-71	on (127) / off (0), push non-latching
Group 1-8 SOLO	1	CC 32-39	on (127) / off (0), toggle latching
Group 1-8 MUTE	1	CC 40-47	on (127) / off (0), toggle latching
Sends On Fader	1	CC 48	on (127) / off (0), toggle latching
Group DCA 1-8	1	Note 72	on (127) / off (0), push non-latching
BUS 1-8	1	Note 73	on (127) / off (0), push non-latching
BUS 9-16	1	Note 74	on (127) / off (0), push non-latching
MTX 1-6	1	Note 75	on (127) / off (0), push non-latching
GROUP Faders	1	CC0-7	0-127

HUI selected and Remote is enabled+active, then the group fader section and buttons will emulate the HUI control surface protocol, i.e. for ProTools.

SELECT/SOLO 1-8 buttons will select or solo the corresponding track in the DAW, in banks of eight tracks

Sends On Fader = enables touch-writing a fader automation on selected track, track automation mode in DAW must be 'touch', (latching)

Use the layer buttons to determine the function assigned to the MUTE 1-8 buttons, the LED displays indicate that function.

- Group DCA 1-8 = allows movement of the bank selection of tracks in a DAW, (push non-latching)
- BUS 1-8 = allows the setting of DAW tracks to 'Record Ready', (push non-latching)
- BUS 9-16 = enables use of MUTE buttons for track mute in the DAW, (latching)
- MTX 1-6 = enables use of MUTE buttons for transport controls in the DAW, (latching).

MACKIE CTRL selected and Remote is enabled+active, then the group fader section and buttons will emulate the Mackie Control Universal protocol

SELECT/SOLO 1-8 buttons will select or solo the corresponding track in the DAW, in banks of eight tracks

Sends On Fader = enables touch-writing a fader automation on selected track, track automation mode in DAW must be 'touch' or 'latch', (latching)

Use the layer buttons to determine the function assigned to the MUTE 1-8 buttons, the LED displays indicate that function.

- Group DCA 1-8 = allows movement of the bank selection of tracks in a DAW, (push non-latching)
- BUS 1-8 = allows the setting of DAW tracks to 'Record Ready', (push non-latching)
- BUS 9-16 = enables use of the MUTE buttons for track mute in the DAW, (latching)
- MTX 1-6 = enables use of the MUTE buttons for transport controls in the DAW, (latching).

4.3 Appendix C: Dimensions

Top View

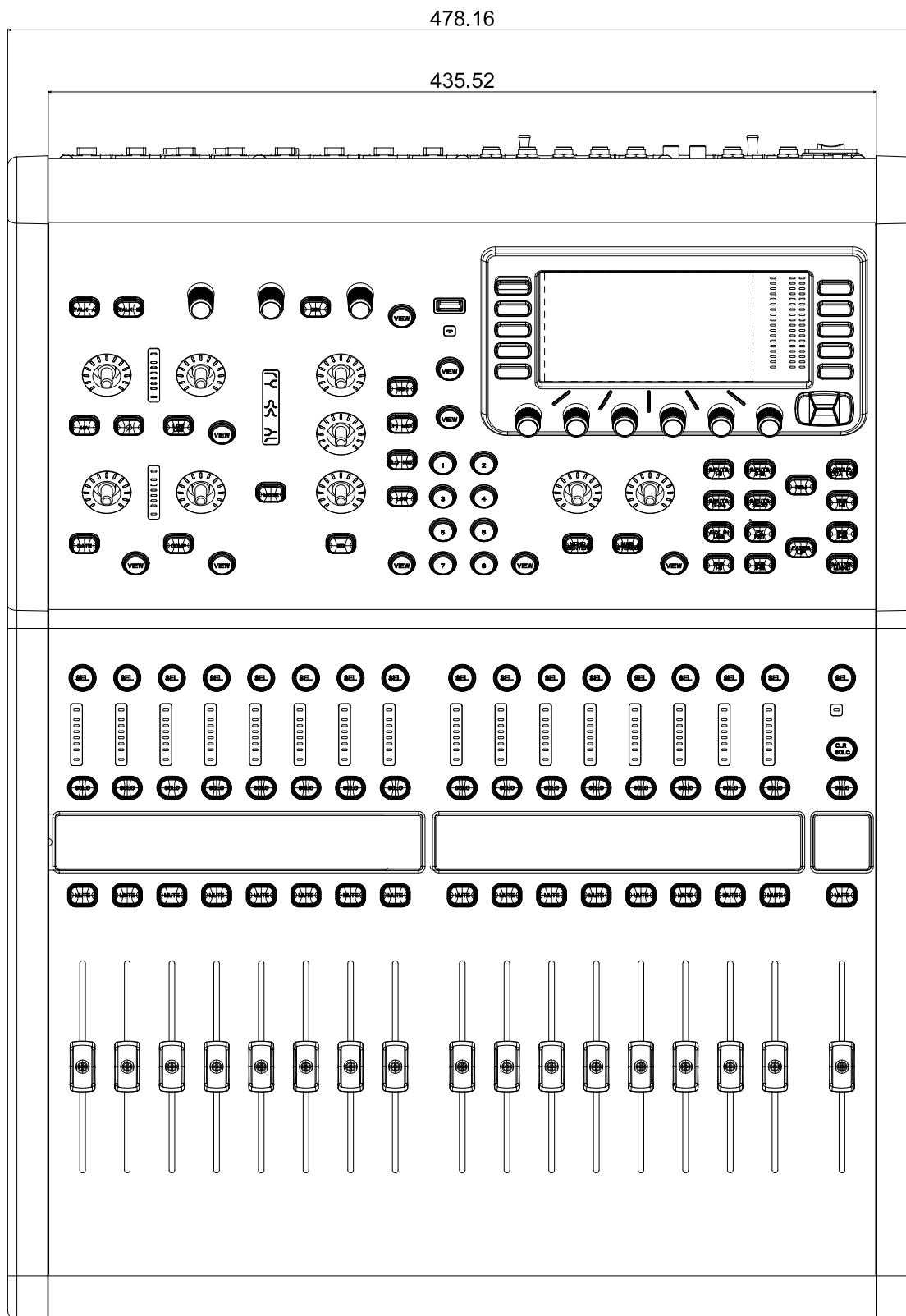

Rear View

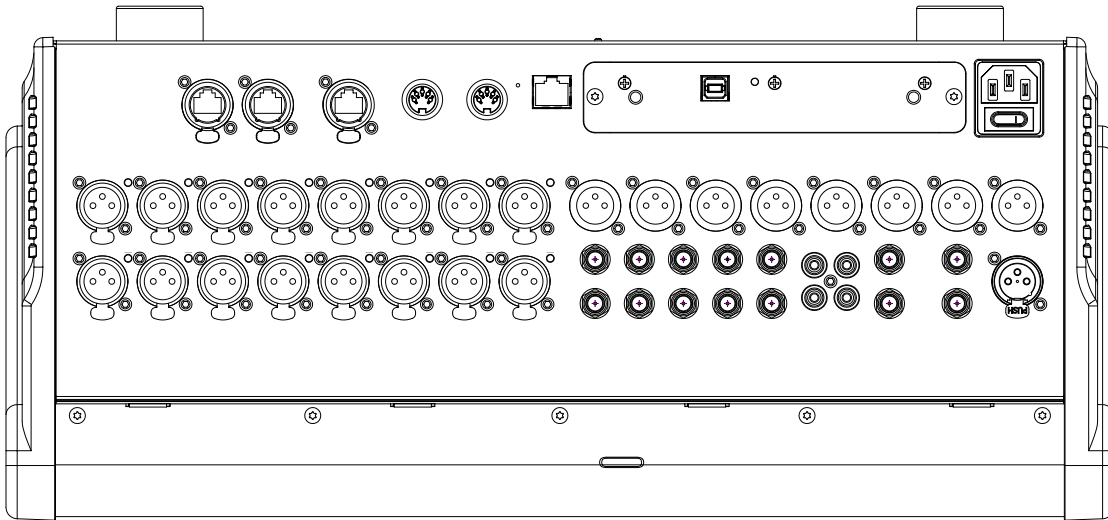

Side View

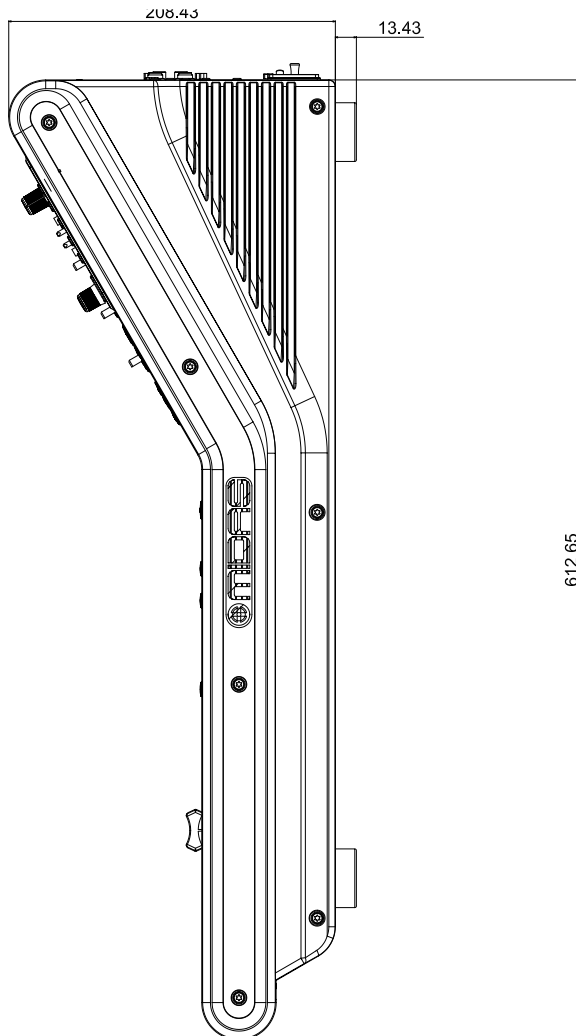

4.4 Appendix D: Block Diagram

Midas M32R Block Diagram

Revision 1.2014-06-27_JD

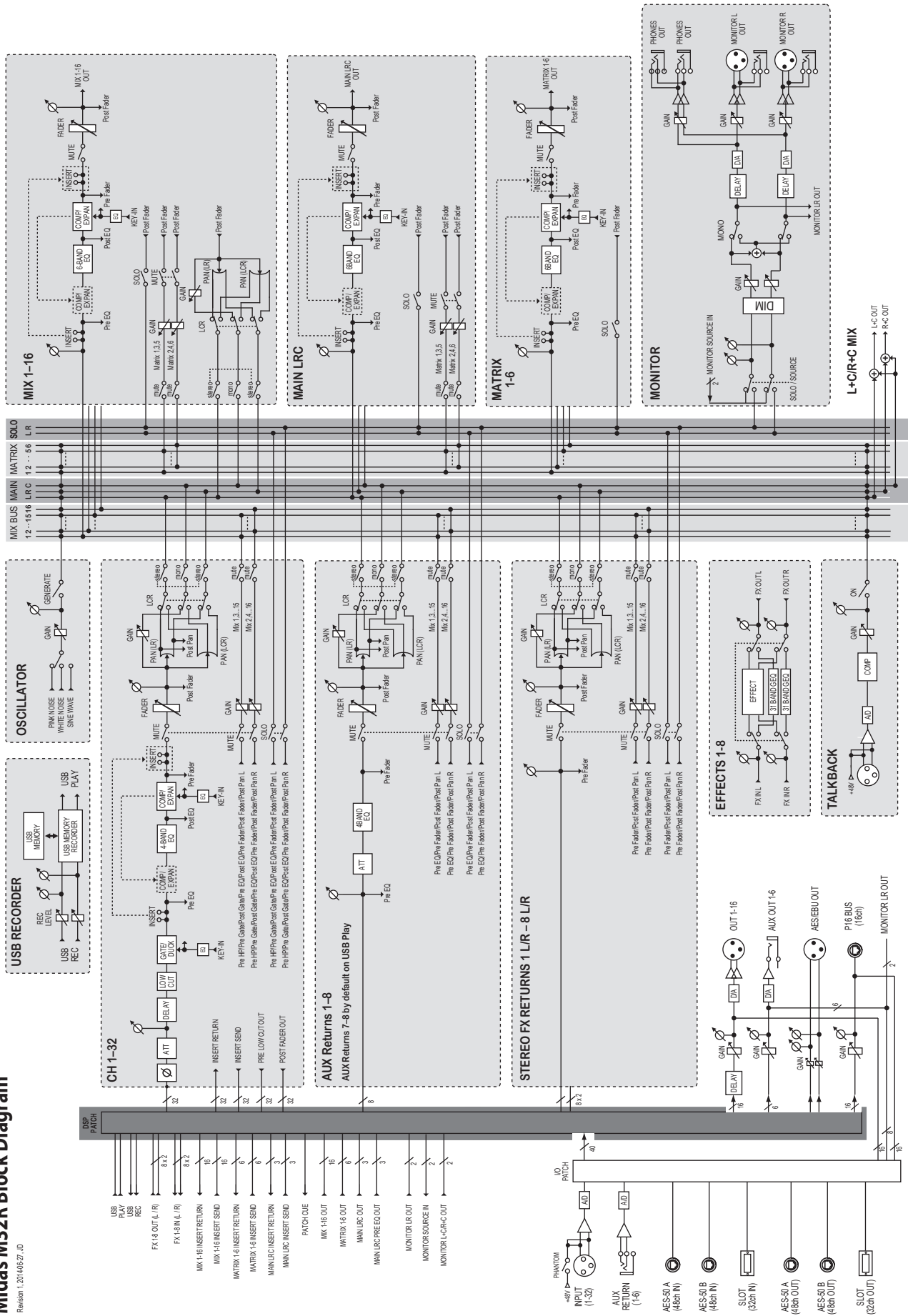

4.5 Appendix E: Service Information

This appendix contains routine service information for the M32R Digital Console.

Routine Maintenance

To help keep your M32R Digital Console unit in good working order and to make sure it gives you optimum performance, we recommend that you carry out the following about once every month.

- Clean the control centre, as detailed in 'Cleaning the control centre' (below)
- Check controls for freedom of operation. As the controls are 'self-cleaning', this operation will help to prevent them from sticking
- Check the functionality of all controls, that is, control knobs, faders, pushbuttons, LEDs, etc.
- Check the functionality of equipment.

Cleaning The Control Centre

Switch off the control centre and electrically isolate it from the mains before cleaning.

Clean the control centre using a dry, lint-free cloth. Do not use harsh abrasives or solvents. When cleaning the equipment, take great care not to damage faders, pushbuttons etc.

Cleaning a GUI Screen

Switch off the control centre and electrically isolate it from the mains before cleaning.

Carefully wipe the surface of the GUI screen with a soft, lint-free cloth or screen wipe specially designed for the purpose. When cleaning the GUI screen, observe the following precautions:

- Avoid putting pressure on the screen
- Don't use harsh abrasives, for example, paper towels
- Don't apply liquids directly to the screen
- Don't use ammonia-based cleaners and solvents, such as acetone.

If you are in doubt or have any queries about cleaning the GUI screens, contact Midas Technical Support.

Equipment Disposal

When this equipment has come to the end of its useful life, its disposal may come under the DIRECTIVE 2012/19/EU OF THE EUROPEAN PARLIAMENT AND OF THE COUNCIL of 27 January 2003 on waste electrical and electronic equipment (WEEE).

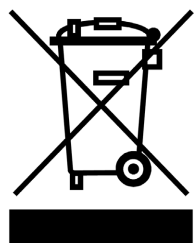

Hazardous substances in WEEE contaminate water, soil and air and ultimately put at risk our environment and health. The directive aims to minimize the impacts of WEEE on the environment during their lifetimes and when they become waste.

The WEEE directive addresses the disposal of products when they have reached the end of their life and contributes to the reduction of wasteful consumption of natural resources. This will help to reduce pollution,

and protect the environment and ourselves.

If this equipment carries a 'crossed-out wheeled bin' (shown left), please do not dispose of WEEE as unsorted municipal waste but collect and dispose of in accordance with local WEEE legislation. The horizontal bar underneath indicates that the product was placed on the EU market after 13th August 2005.

For WEEE disposal see our website at midasconsoles.com for information.

4.6 Appendix F: Glossary

This glossary provides an explanation of the symbols, terms and abbreviations used in this manual.

5.1 surround: A surround sound system created from six channels that form a discrete signal, which is played back over a speaker system comprising five speakers (three front and two rear) and a subwoofer (which is the '.1' or LFE channel). See LFE.

μ: Micro- prefix symbol that represents 10⁻⁶ or one millionth.

A

A/D: Abbreviation for 'analogue to digital'. The conversion of a continuous signal into a numeric discrete sample sequence.

AC: Abbreviation for 'alternating current'.

AES/EBU: Abbreviation for 'Audio Engineering Society/European Broadcasting Union'. See AES3.

Acoustic feedback: A sound loop existing between an audio input and audio output that is amplified on each cycle. For example, a mic input signal is amplified and passed to a loudspeaker. The output from the loudspeaker is picked up by the mic, which amplifies it again and passes it back to the loudspeaker, and so on.

AES3: Also known as 'AES/EBU', this is a serial interface for transferring digital audio between devices.

AES50: AES digital audio engineering standard. AES50 is a high resolution, multi-channel audio interconnection (HRMAI). Rather than a network, it is a high-performance, point-to-point audio interconnection, although the auxiliary data may operate as a true network, independently of the audio. HRMAI provides a professional multi-channel audio interconnection that uses Cat 5e data cable and is compatible with Ethernet networks.

AFL: Abbreviation for 'after fader listen'. A function that allows the signal to be monitored post-fader, that is, after it has been acted upon by the fader.

Algorithm: In computing, a set of instructions for accomplishing a specific task.

amp (A): Abbreviation for 'ampere'. A unit of current.

Anti-aliasing: When referring to digital images, a technique that avoids poor pixelation.

Area A: Primary input control area.

Area B: A secondary input control area.

Assignable controls: User-assignable controls that can be set up to operate other functions.

Auto safe: Prevents channel from accepting scene recall.

Auto-mute: A function that automatically mutes the channel's signal under certain conditions.

Auto-mute group: A function that automatically mutes a number of selected channels under certain conditions.

Automation: 1. Memorization and playback of changes made to mixer settings. 2. An area on the master bay that controls these.

Aux: Abbreviation for 'auxiliary send' or 'aux send'. A designation for extra buses, typically used for sending signal to effects, headphone amps and other destinations. See Bus.

Aux send: See Aux.

B

Balanced audio: A type of audio connection that uses the three leads in a cable, connector and jack as part of a phase-cancelling arrangement to boost the signal and reduce noise.

Band: In EQ, a range of frequencies.

Bandwidth: In EQ, the width of a band, that is, the number of frequencies that will be boosted/cut above and below a centre frequency.

Bank: A fixed number of channels displayed on a GUI screen.

Bass: Lower frequencies in a signal.

Bay: One of the main control surface sections.

Bus: A pathway down which one or more signals can travel.

C

Cat 5e: A specification for a type of cable used typically for Ethernet computer networks.

Channel: Single path taken by an audio signal (input or output) through the control centre.

Channel strip: Row of controls in traditional analogue layout used for the shaping of a signal.

Checkpoint: A patching data store point, created by clicking CHECKPOINT. See Patching.

Click: A method of GUI operation, mainly for button operation and selection purposes.

CMR: Abbreviation for 'common mode rejection'. A measure of how well a differential amplifier rejects a signal that appears simultaneously and in-phase at both input terminals. CMR is usually stated as a dB ratio at a given frequency.

Comb filtering: Removal of signal components at a number of regularly spaced frequencies.

Compressor: A dynamics processor that reduces the level of any signal exceeding a specified threshold volume.

Condenser microphone: A high quality mic that uses a capacitor to detect changes in the ambient air pressure, which it then converts into an electrical signal. This type of mic requires power from a battery or external source.

Control centre: The M32's console, comprising control surface and GUI.

Control surface: Area on the control centre that houses all of the user's hardware controls, such as pushbuttons, control knobs, switches etc.

Crossfade: To combine signals such that one channel or source fades out while another fades in, but maintaining an essentially constant programme volume.

Cursor: Generally, used to describe the 'I'-shaped pointer on the GUI that indicates a text insertion point. See Pointer.

D

D zone: Section in the input channel strip for controlling dynamic parameters.

D/A: Abbreviation for 'digital to analogue'. The conversion of digital data to analogue audio.

DARS: Abbreviation for 'digital audio reference signal'.

Dashboard: A standard GUI screen display - usually on the master bay - that shows all channel meters (inputs, auxes, returns, masters etc.) all of the time.

DAW: Abbreviation for 'Digital Audio Workstation'. A digital audio workstation is an electronic system designed solely or primarily for recording, editing and playing back digital audio.

dB: Symbol for 'decibel'. A unit of measurement of the loudness of sound. See dBu.

dBu: A unit of measurement of sound used in professional audio. Derived from the decibel, where the 'u' stands for unloaded, this unit is an RMS measurement of voltage based on 0.775 VRMS, which is the voltage at which you get 1 mV of power in a 600 ohm resistor. This used to be the standard impedance in most professional audio circuits.

DC: Abbreviation for 'direct current'.

Delay: An effect by which a reproduction of a signal is played back later than its original.

Destination: The patch connector to which a signal is routed. See Patching.

Device: A diagram(s) in the I/O tabs representing a physical rack unit, such as a line I/O, mic splitter, DN9696, AES50 etc. See Patching.

DI: Abbreviation for 'direct inject' or 'direct injection'. Signal is plugged directly into the audio chain without using a microphone.

DI box: Device for matching signal level impedance of a source to mixer input.

Drag: A method of GUI operation, mainly for control adjustment. Also used for selecting blocks of patch connectors during patching.

DSP: Abbreviation for 'digital signal processing' or 'digital signal processor'. Any signal processing done after an analogue audio signal has been converted into digital audio. Can be used to create, for example, compression, equalisation etc., of a digital signal. A digital signal processor is a piece of equipment specifically designed for carrying out signal processing.

E

E zone: Section in the input channel strip for controlling EQ parameters.

Effect: One of a number of audio processes that can be applied to a signal to modify it, such as reverb, flanging, phasing, delay etc.

Effects rack: A virtual rack of internal processors. See Virtual rack.

Envelope: 1. How a sound or audio signal varies in intensity over time.
2. The visual representation of such, usually shown on a graph in a GUI channel strip.

EQ: Abbreviation for 'equaliser' or 'equalisation'.

Equalisation: Adjusting the frequency response so that the levels of all frequencies are equal or the same. Bass and treble controls are equalisation controls.

F

Fader: Slider-type device for precise adjustment of signal level or volume of a channel.

Fast strip: One of the strips in the input, mix and output fast zones. See Input fast strip, Mix fast strip, Output fast strip and Fast zone.

Fast zone: An area on a bay that contains quick controls. See Input fast zone, Mix fast zone, Output fast zone and Fast strip.

FB: Abbreviation for 'front-back'. A term used in surround panning.

Feedback: See Acoustic feedback.

Filter: A device for removing frequencies above or below certain levels.

FOH: Abbreviation for 'front of house'. The area in a theatre used by the public. Used to describe a control centre being used to control the sound that the audience will hear (and not the performers' monitor system).

Frequency: The number of times that a sound wave's cycle repeats within one second.

Fricative: A consonant, such as 'f' or 's', produced by the forcing of breath through a constricted passage.

From section: The leftmost area of the patching screen that contains the source patch connectors. See Patching.

G

Gain: Another term for signal level.

Gain reduction (compressor): Decrease in gain when input signal is above threshold. See Gain.

GEQ: Abbreviation for 'graphic equaliser'. See Graphic EQ.

GEQ rack: A virtual rack of GEQs. See Virtual rack.

Granularity: A measure of the size of components or a description of the components comprising a system.

Graphic EQ: A form of EQ that has a number of faders for controlling the gain of the audio signal. The faders are set at frequency bands that are evenly-spaced according to octaves.

GUI: Abbreviation for 'graphical user interface'.

GUI channel strip: Right section of a GUI screen that represents the processing area of the input or output channel strip selected to the control surface.

GUI menu: A menu selectable at either GUI screen by clicking the home button (upper-left corner).

GUI screen: One of the M32's two screens, which comprise the GUI.

H

HPF: Abbreviation for 'high pass filter'. A filter that removes lower frequencies from a signal, leaving the higher frequencies unaffected.

Hum: Undesirable low frequency tone present in a signal due to grounding problems or proximity to a power source.

Hz: Symbol for 'Hertz'. A unit of frequency equal to one cycle of a sound wave per second.

I

I zone: Area on the master bay that contains the operator-assignable effects controls.

I/O: Abbreviation for 'input/output'.

ID: Abbreviation for 'identification'.

Ident: Scale marking, or gradation, around a control knob to help indicate the current setting and to assist in accurate adjustment.

Impedance (Z): Opposition to the flow of alternating current in a circuit, measured in ohms.

K

Kernel: For computers, the kernel is the central component of most operating systems.

L

LCD select button: LCD button in the input faders and VCA groups, used for channel/group navigation and selection, and operator feedback.

LFE: Abbreviation for 'low frequency effects'. Typically, the '.1' in '5.1 surround' is an LFE channel.

LFO: 1. Abbreviation for Low-Frequency Oscillation, an electronic signal which is usually below 20 Hz and creates a rhythmic pulse or sweep. This pulse or sweep is often used to modulate synthesizers, delay lines and other audio equipment in order to create effects used in the production of electronic music.
2. Abbreviation for Low-Frequency Oscillator, the device itself which produces low-frequency oscillation.

LS: Abbreviation for 'left surround'. The left rear speaker in a 5.1 surround system.

M

MADI: Abbreviation for 'multi-channel audio digital interface'.

Master bay: Control area for masters, automation, comms, monitoring etc. Also contains the primary navigation zone.

Masters: The three master channels (mono and stereo left and right) in the master bay.

MB: Abbreviation for 'megabyte'.

MC: Abbreviation for 'master controller'.

Meter: Visual device to indicate the level of a signal.

Meters screen: One of the GUI screens. This is the default screen of the master bay.

Mic: Abbreviation for 'microphone'.

Microphone: Device for converting sound waves into audio signals.

MIDI: Acronym for 'musical instrument digital interface'. A digital signal system standard that facilitates integration of musical instruments, such as synthesizers and guitars, with computers.

Mix: 1. A signal that contains a combination of signals, such as a pair of stereo signals with numerous effects. 2. The act of creating such a combination. 3. A type of bus. See Bus.

Mix bay: Control area for outputs and groups.

Mixer: 1. A console or other device that blends input signals into composite signals for output. 2. An engineer/technician who carries this out, especially during a live performance.

mm: Symbol for 'millimetre' (one thousandth of a metre).

MON: Abbreviation for 'monitor', used to describe a control centre being used to mix the signals sent to the stage monitor speakers.

Monitor: 1. Speaker(s) used for listening to a mix or live audio. 2. The act of listening to a mix or live audio.

Monitor A: Primary monitor bus system.

Monitor B: Secondary monitor bus system.

Monitors: Control area on the master bay for monitoring the A and B signal paths.

Mono: A single signal.

Mute: Function that allows a channel's signal to be silenced.

Mute safe: Function that means a mute cannot be controlled by scene recall or auto-mutes.

N

N/A: Abbreviation for 'not applicable'.

nm: Symbol for nanometre (one billionth of a metre).

Normalise: To boost the amplitude of a digital sound so that it is as high as it can be without clipping (0 dB).

Normalisation: An automatic process whereby the gain of all program material is adjusted so that the peak level will just arrive at 0 dB.

Normalised connection: Also known as 'normalised connection'. A connection that allows a signal to pass through it when no plug is inserted in it, but breaks the connection when a plug is inserted.

Normalising: The process of making audio files the same volume.

NVRAM: Abbreviation for 'Non-volatile random access memory'. This is the general name used to describe any type of RAM that retains its information when power is switched off. For example, flash memory.

O

O/B: Abbreviation for 'outside broadcast'.

Oct: Abbreviation for 'octave'.

Octave: A difference in pitch where one tone has a frequency that is double or half of the frequency of another tone.

ohm (Ω): Unit of electrical resistance.

OS: Abbreviation for 'operating system'.

OSC: Abbreviation for 'oscillator' or 'oscillation'.

Out of phase: 1. A signal, being similar to another in amplitude, frequency and wave shape, but offset in time by part of a cycle. 2. 180° out of phase or having opposite polarity. See Phase.

Outboard: External, as in an 'external device'.

Outboard equipment: External equipment used with the M32 Control Centre, but that is not part of it.

Output: 1. The signal put out by a device. 2. The physical location of where a device sends out a signal.

Output fast strip: One of 16 channel strips in the output fast zone. Provides detailed control of the currently selected outputs. See Output fast zone.

Output fast zone: Control area for fast access to primary main output functions.

Overload: A condition where the signal level is too high.

Overview: The main view in the GUI channel strip, which contains the control sections of the selected channel. This represents the associated channel strip on the control surface.

Overview screen: One of the GUI screens. This is the default screen of the mix bay.

P

PAN: Abbreviation for 'panoramic'.

Panning: The left/right positioning of a signal across a stereo image.

Parameter: A setting whose value can be altered by the user.

Parametric EQ: A type of EQ that allows all of the parameters of equalisation to be changed, including centre frequency, boost/cut in gain and bandwidth.

Patch: A temporary connection (physical or virtual) made between two audio devices or inside one.

Patch connector: Any tab patching point, for example, an XLR connector, bus, sidechain compressor etc. See Patching.

Patching: Also known as 'soft patching'. The process of routing a channel/signal from a source to a destination(s).

PCB: Abbreviation for 'printed circuit board'.

PEQ: Abbreviation for 'parametric equaliser'. See Parametric EQ.

PFL: Abbreviation for 'pre-fade listen'. A function that allows the signal to be monitored pre-fader, that is, before it reaches the fader.

Phantom power: The power required for the operation of a condenser microphone when it is not supplied by internal batteries or a separate power supply. This is supplied by the M32 Control Centre itself.

Phase: A measurement (in degrees) of the time difference between two waveforms.

Pitch: A continuous frequency over time. Musical interpretation of an audio frequency.

Pitch shift: Alteration of pitch or frequency, but without adjusting tempo.

Point scene: Subdivision of a scene. See Scene.

Pointer: 1. On the GUI, the pointer is the arrow-shaped object on the screen that moves when the user moves the trackball or external mouse. 2. On a control knob, it is the marking that, when used in conjunction with the indent around edge of control knob, helps to indicate the setting.

POP: Abbreviation for 'population'.

POP group: A number of channels assigned to a group that has unfold and area B controls. Provides an easy and quick method of manipulating and controlling the numerous channels available on the M32 Control Centre.

Post-: The point for accessing audio just after it leaves a specific channel component, for example, 'post-fader', where the audio is tapped from just after it leaves the channel's main level control.

Pre-: The point for accessing audio just before it reaches a specific module, for example, 'pre-EQ', where the audio is tapped from just before it gets to a channel strip's EQ.

Primary navigation zone: Area in the master bay for mix and master bay GUI screen navigation and control. Also has a screen access section for fast access to GUI menu options.

Processing area: A display in a GUI channel strip showing a specific control section. Accessed from the channel's overview display. See Overview.

PSU: Abbreviation for 'power supply unit'.

Psychoacoustics: The study of the perception of sound, that is, how we listen, our psychological responses and the physiological effects on the human nervous system.

Psychoacoustic noise: Noise that affects the physiology of the listener.

Q

Quick access button: Button for navigation/ selection of a channel/bus/ processing area.

R

RAM: Abbreviation for 'Random access memory'.

Return: Auxiliary return or aux return. An extra input used for receiving a signal from the output of an internal or external effect processor. See Bus.

Reverb: An effect where the ambience of a physical space is simulated. This is done by copying a signal and replaying at regular intervals at ever decreasing levels. The intervals are so close that each copy is not heard individually.

RMS: Abbreviation for 'root-mean-square'. The square root of the mean of the sum of the squares. Commonly used as the effective value of measuring a sine wave's electrical power. A standard in amplifier measurements. The effective average value of an AC waveform.

RS: Abbreviation for 'right surround'. The right-hand rear speaker in a 5.1 surround system.

S

s: Symbol for 'second'. A unit of time.

Scene: In automation, a set of mix settings for a particular part of a performance, for example, a play or song.

Sibilance: Energy from a voice, centred around 7 kHz, and caused by pronouncing 's', 'sh' or 'ch' sounds.

Side chain: A special circuit that diverts a proportion of the main signal so that it can be processed, as required. Compressors use the side chain to derive their control signals.

Signal flow: The path of a signal from one place to another.

SIP: Abbreviation for 'solo in place'.

SIS: Abbreviation for 'spatial imaging system'. Combines a central loudspeaker cluster with a left-right system to form three discrete sound channels.

Snapshot: A captured group of mixer settings that reflect the state of the mixer at a particular moment within a performance. This snapshot can then be recalled at the required moment in the performance/playback.

Solo: During monitoring, the isolation of one signal by silencing all other signals.

Source: The patch connector from which a signal is patched. See Patching.

SPL: Abbreviation for 'sound pressure level'. Given in decibels (dB), SPL is an expression of loudness or volume.

Splash screens: The GUI display during power up.

SRC: Abbreviation for 'sample rate converter'.

SSD: Abbreviation for 'solid-state disk'. Data storage device that uses non-volatile memory to store data. Quicker than the conventional hard disk and less susceptible to the failures associated with hard disk drives.

Status indicator: A device specifically designed to show the condition of something. For example, an LED that shows whether a pushbutton is on or off, or a meter showing the level of a signal.

Stereo: Two separate channels, left and right, used to give the listener the perception of where the noise is coming from. Usually used with music to give a fuller, more natural sound.

Stereo image: The perception of the different sound sources coming from far left, far right or anywhere in between.

Surround: Audio that has more than two speaker locations and, therefore, more than two channels. Also commonly termed 'surround sound'.

Synchronisation (sync): Coordination of timing between devices.

T

Tab: A 'sheet' in the From and To sections that contains a specific group of patch connectors. See Patching.

TFT: Abbreviation for 'thin film transistor'.

Threshold: Level at which dynamics processing will begin to operate.

Tie line: A dedicated connection between two systems, typically between FOH and MON positions.

To section: The rightmost area of the Patching screen that contains the destination patch connectors. See Patching.

Tooltip: The information box that appears next to the pointer when it passes over or pauses on items on certain GUI screens, such as the channels on the Overview and Patching screens.

Touchpad: Also known as 'trackpad'. An input device on a laptop PC for controlling the on-screen pointer.

Track: Single stream of recorded audio data.

Trackball: Device, located in the primary navigation zone, for GUI screen navigation and control of the mix and master bays.

Treble: Higher frequencies in a signal.

TW: Abbreviation for 'twin-wire'.

U

Unbalanced audio: A type of audio connection that utilises only two of the leads of a cable, connector and jack.

Unfold: Navigates the input channels of a group to the input bays.

USB: Abbreviation for 'universal serial bus'. A 'plug and play' interface that provides a fast connection between a computer and peripherals, such as keyboards, printers, scanners, digital cameras etc.

V

VCA: Abbreviation for 'variable control association' (also 'voltage controlled amplifier').

VCA fader: The fader control of a VCA group.

VCA group: A group of channels that are controlled globally, such as via their group's fader and other controls. Provides an easy and quick method of manipulating and controlling the numerous channels available on the M32 Control Centre.

VGA: Abbreviation for 'video graphics array'. A graphics display system for PCs developed by IBM.

Virtual rack: A traditional 19" rack, represented on the GUI. A virtual rack will, typically, contain internal devices, such as effects and GEQs.

Volt (V): A unit of electrical potential differential or electromotive force.

Volume: General term for a signal's loudness.

W

Window: A small self-contained panel that appears on the GUI, usually after selection of a specific control. Typically, contains a number of user-selectable options or information in the form of a message or prompt.

X

X-over: Abbreviation for 'crossover'.

XLR connector: High-quality three-pin audio connector, which is also used for AES/EBU digital audio connections.

Other important information

EN Important information

1. Register online. Please register your new Music Tribe equipment right after you purchase it by visiting behringer.com. Registering your purchase using our simple online form helps us to process your repair claims more quickly and efficiently. Also, read the terms and conditions of our warranty, if applicable.

2. Malfunction. Should your Music Tribe Authorized Reseller not be located in your vicinity, you may contact the Music Tribe Authorized Fulfiller for your country listed under "Support" at behringer.com. Should your country not be listed, please check if your problem can be dealt with by our "Online Support" which may also be found under "Support" at behringer.com. Alternatively, please submit an online warranty claim at behringer.com BEFORE returning the product.

3. Power Connections. Before plugging the unit into a power socket, please make sure you are using the correct mains voltage for your particular model. Faulty fuses must be replaced with fuses of the same type and rating without exception.

FR Informations importantes

1. Enregistrez-vous en ligne. Prenez le temps d'enregistrer votre produit Music Tribe aussi vite que possible sur le site Internet behringer.com. Le fait d'enregistrer le produit en ligne nous permet de gérer les réparations plus rapidement et plus efficacement. Prenez également le temps de lire les termes et conditions de notre garantie.

2. Dysfonctionnement. Si vous n'avez pas de revendeur Music Tribe près de chez vous, contactez le distributeur Music Tribe de votre pays : consultez la liste des distributeurs de votre pays dans la page "Support" de notre site Internet behringer.com. Si votre pays n'est pas dans la liste, essayez de résoudre votre problème avec notre "aide en ligne" que vous trouverez également dans la section "Support" du site behringer.com. Vous pouvez également nous faire parvenir directement votre demande de réparation sous garantie par Internet sur le site behringer.com AVANT de nous renvoyer le produit.

3. Raccordement au secteur. Avant de relier cet équipement au secteur, assurez-vous que la tension secteur de votre région soit compatible avec l'appareil. Veillez à remplacer les fusibles uniquement par des modèles exactement de même taille et de même valeur électrique — sans aucune exception.

PT Outras Informações Importantes

1. Registre-se online. Por favor, registre seu novo equipamento Music Tribe logo após a compra visitando o site behringer.com. Registrar sua compra usando nosso simples formulário online nos ajuda a processar seus pedidos de reparos com maior rapidez e eficiência. Além disso, leia nossos termos e condições de garantia, caso seja necessário.

2. Funcionamento Defeituoso. Caso seu fornecedor Music Tribe não esteja localizado nas proximidades, você pode contatar um distribuidor Music Tribe para o seu país listado abaixo de "Suporte" em behringer.com. Se seu país não estiver na lista, favor checar se seu problema pode ser resolvido com o nosso "Suporte Online" que também pode ser achado abaixo de "Suporte" em behringer.com. Alternativamente, favor enviar uma solicitação de garantia online em behringer.com ANTES da devolução do produto.

3. Ligações. Antes de ligar a unidade à tomada, assegure-se de que está a utilizar a voltagem correcta para o modelo em questão. Os fusíveis com defeito terão de ser substituídos, sem qualquer excepção, por fusíveis do mesmo tipo e corrente nominal.

ES Aspectos importantes

1. Registro online. Le recomendamos que registre su nuevo aparato Music Tribe justo después de su compra accediendo a la página web behringer.com. El registro de su compra a través de nuestro sencillo sistema online nos ayudará a resolver cualquier incidencia que se presente a la mayor brevedad posible. Además, aproveche para leer los términos y condiciones de nuestra garantía, si es aplicable en su caso.

2. Averías. En el caso de que no exista un distribuidor Music Tribe en las inmediaciones, puede ponerse en contacto con el distribuidor Music Tribe de su país, que encontrará dentro del apartado "Support" de nuestra página web behringer.com. En caso de que su país no aparezca en ese listado, acceda a la sección "Online Support" (que también encontrará dentro del apartado "Support" de nuestra página web) y compruebe si su problema aparece descrito y solucionado allí. De forma alternativa, envíenos a través de la página web una solicitud online de soporte en periodo de garantía ANTES de devolvernos el aparato.

3. Conexiones de corriente. Antes de enchufar este aparato a una salida de corriente, asegúrese de que dicha salida sea del voltaje adecuado para su modelo concreto. En caso de que deba sustituir un fusible quemado, deberá hacerlo por otro de idénticas especificaciones, sin excepción.

DE Weitere wichtige Informationen

1. Online registrieren. Bitte registrieren Sie Ihr neues Music Tribe-Gerät direkt nach dem Kauf auf der Website behringer.com. Wenn Sie Ihren Kauf mit unserem einfachen online Formular registrieren, können wir Ihre Reparaturanträge schneller und effizienter bearbeiten. Lesen Sie bitte auch unsere Garantiebedingungen, falls zutreffend.

2. Funktionsfehler. Sollte sich kein Music Tribe Händler in Ihrer Nähe befinden, können Sie den Music Tribe Vertrieb Ihres Landes kontaktieren, der auf behringer.com unter „Support“ aufgeführt ist. Sollte Ihr Land nicht aufgelistet sein, prüfen Sie bitte, ob Ihr Problem von unserem „Online Support“ gelöst werden kann, den Sie ebenfalls auf behringer.com unter „Support“ finden. Alternativ reichen Sie bitte Ihren Garantieanspruch online auf behringer.com ein, BEVOR Sie das Produkt zurücksenden.

3. Stromanschluss. Bevor Sie das Gerät an eine Netzsteckdose anschließen, prüfen Sie bitte, ob Sie die korrekte Netzspannung für Ihr spezielles Modell verwenden. Fehlerhafte Sicherungen müssen ausnahmslos durch Sicherungen des gleichen Typs und Nennwerts ersetzt werden.

JP その他の重要な情報

1. ヒューズの格納部 / 電圧の選択: ユニットをパワーソケットに接続する前に、各モデルに対応した正しい主電源を使用していることを確認してください。ユニットによっては、230V と 120V の 2 つの違うポジションを切り替えて使う、ヒューズの格納部を備えているものがあります。正しくない値のヒューズは、絶対に適切な値のヒューズに交換されている必要があります。

2. 故障: Music Tribe ディーラーがお客様のお近くにはないときは、midasconsoles.com の "Support" 内に列記されている、お客様の国の Music Tribe ディストリビューターにコンタクトすることができます。お客様の国がリストにない場合は、同じ midasconsoles.com の "Support" 内にある "Online Support" でお客様の問題が処理できないか、チェックしてみてください。あるいは、商品を返送する前に、midasconsoles.com で、オンラインの保証請求を要請してください。

3. 電源接続: 電源ソケットに電源コードを接続する前に、本製品に適切な電圧を使用していることをご確認ください。不具合が発生したヒューズは必ず電圧および電流、種類が同じヒューズに交換する必要があります。

CN 其他的重要信息

- 1. 在线注册。**请购买 Music Tribe 产品后立即在 midasconsoles.com 网站注册。网页上有简单的在线注册表格。这有助于我们更快更有效率地处理您维修等事宜。请阅读保修的相关条款及条件。
- 2. 无法正常工作。**若您的 Music Tribe 产品无法正常工作,我们会为您尽快修复。请联系您购买产品的销售商。若你所在地区没有 Music Tribe 销售商,请联系 midasconsoles.com 网站的“WHERE TO BUY”一栏下的所列出的子公司或经销商。
- 3. 电源连接。**将本设备连接电源前,请确保使用的电压正确。保险丝需要更换时,必须使用相同型号及定额的保险丝。

EN

ES

FR

DE

PT

JP

CN

FEDERAL COMMUNICATIONS COMMISSION COMPLIANCE INFORMATION



Responsible Party Name: **Music Tribe Brands UK Ltd.**
Address: **Klark Industrial Park,
Walter Nash Road,
Kidderminster, Worcestershire,
DY11 7HJ United Kingdom**
Phone Number: **+44 1562 732290**

DIGITAL RACK MIXER M32R

complies with the FCC rules as mentioned in the following paragraph:

This equipment has been tested and found to comply with the limits for a Class A digital device, pursuant to Part 15 of the FCC Rules. These limits are designed to provide reasonable protection against harmful interference when the equipment is operated in a commercial environment. This equipment generates, uses, and can radiate radio frequency energy and, if not installed and used in accordance with the instruction manual, may cause harmful interference to radio communications. Operation of this equipment in a residential area is likely to cause harmful interference in which case the user will be required to correct the interference at his own expense.

Important information:

Changes or modifications to the equipment not expressly approved by Music Tribe can void the user's authority to use the equipment.

