

Portable Speakers

# PERFORMER TPX152

2 Way 15" Full Range Loudspeaker for  
Portable PA Applications

- 2 way full range loudspeaker for portable PA applications
- 250 Watts continuous, 1,000 Watts peak power
- High excursion 15" low frequency driver with low mass voice coil for improved transient response
- Aluminium dome 1" compression driver with extended high frequency reproduction
- Low distortion waveguide provides 70° H x 50° V dispersion
- Hard wearing carpet covered 18 mm (¾") wood construction
- Rugged powder coated perforated steel mesh grille
- Durable handles for easy lifting and carrying
- Dual angle pole mount for accurate audience coverage
- Neutrik speakON\* NL4 connectors for reliable long life operation
- 3-Year Warranty Program\*
- Designed and engineered in England



The 2-way full range TPX152 is a passive 15" 1,000 Watt loudspeaker system that is ideally suited for a wide range of portable speech and music sound reinforcement, including FOH, side and drum fill applications. Engineered as a standalone 2-way system not requiring any external equalization or filtering, the TPX152 achieves optimal performance when paired with a subwoofer and **TURBOSOUND** loudspeaker management systems.



The TPX152 loudspeaker features a high excursion 15" low frequency driver with a low mass voice coil for improved transient response, and an aluminium dome 1" compression driver mounted on a 70° horizontal by 50° vertical low distortion waveguide. All drivers are matched with an internal passive crossover network in a reflex-loaded enclosure.

Covered in hard wearing black carpet, the cabinet is of 18 mm (¾") wood construction – and includes a rugged powder coated perforated steel mesh grille backed with reticulated foam, a dual-angle pole mount socket for use with 35 mm poles/speaker stands to optimise audience coverage, and durable handles for easy transport. A rear panel connector plate carries Neutrik speakON\* NL4 connectors for input and link connections to additional enclosures.

\*All third-party trademarks are the property of their respective owners. Their use neither constitutes a claim of the trademark nor affiliation of the trademark owners with MUSIC Group. Product names are mentioned solely as a reference for compatibility, effects and/or components. Warranty details can be found at [music-group.com](http://music-group.com).

# PERFORMER TPX152

2 Way 15" Full Range Loudspeaker for  
Portable PA Applications

## Frequency Response Sensitivity 1 W / 1 m

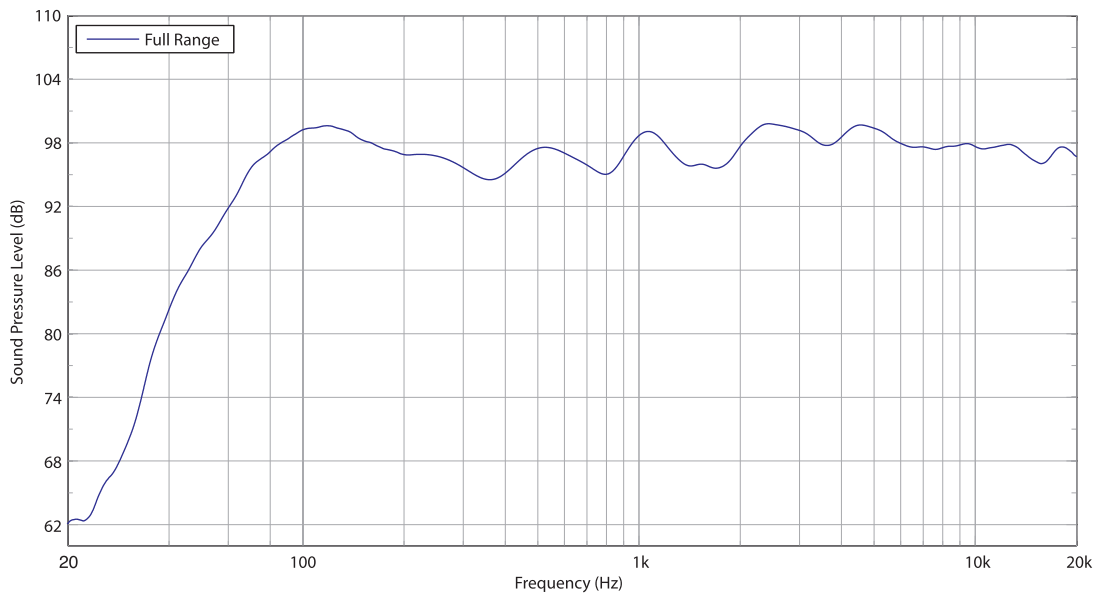

## Impedance

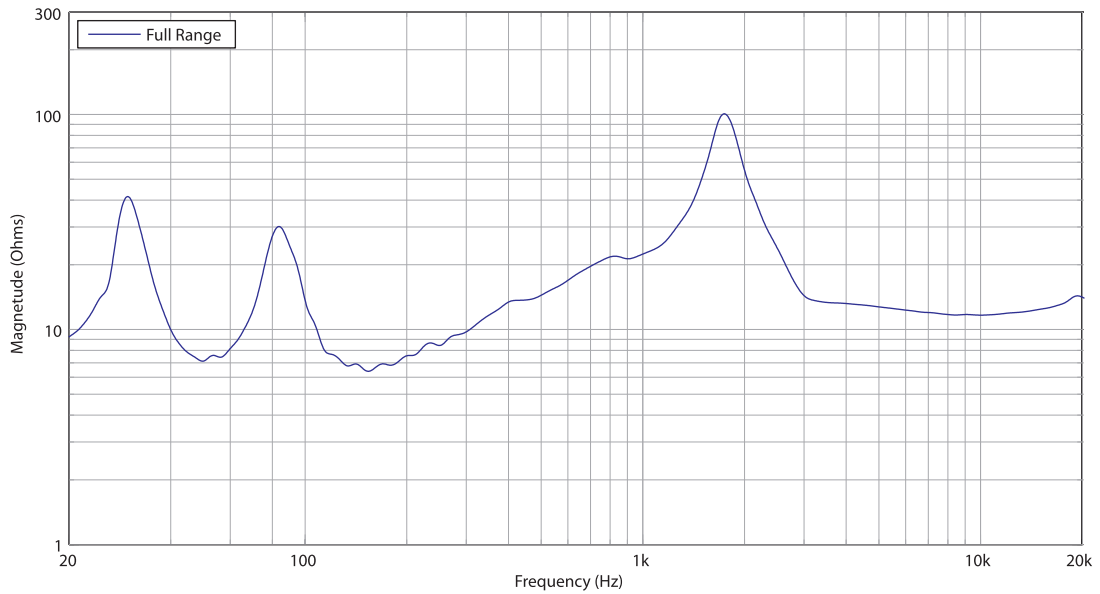

# PERFORMER TPX152

2 Way 15" Full Range Loudspeaker for  
Portable PA Applications

## Horizontal Beamwidth

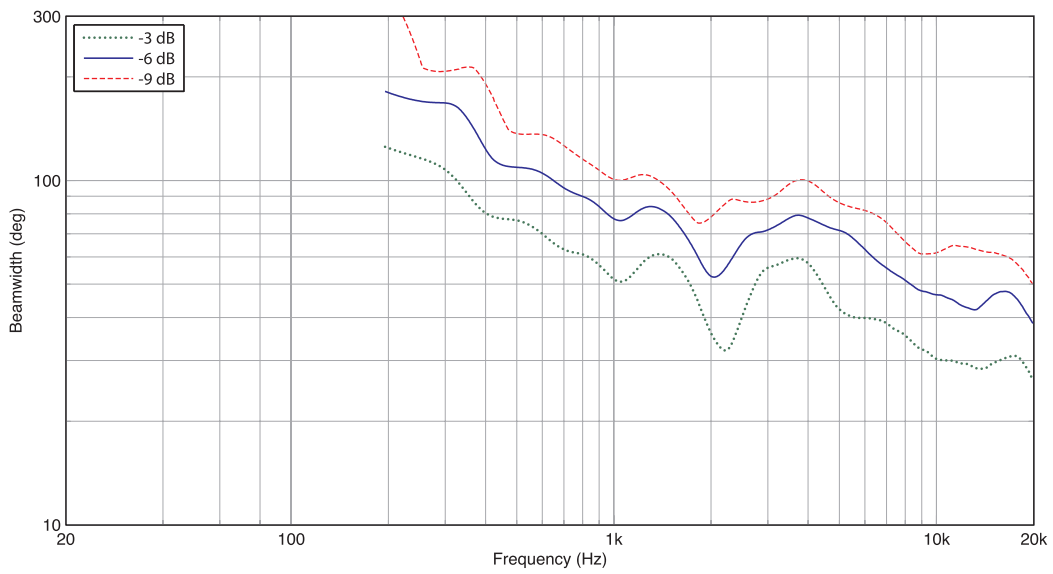

## Vertical Beamwidth

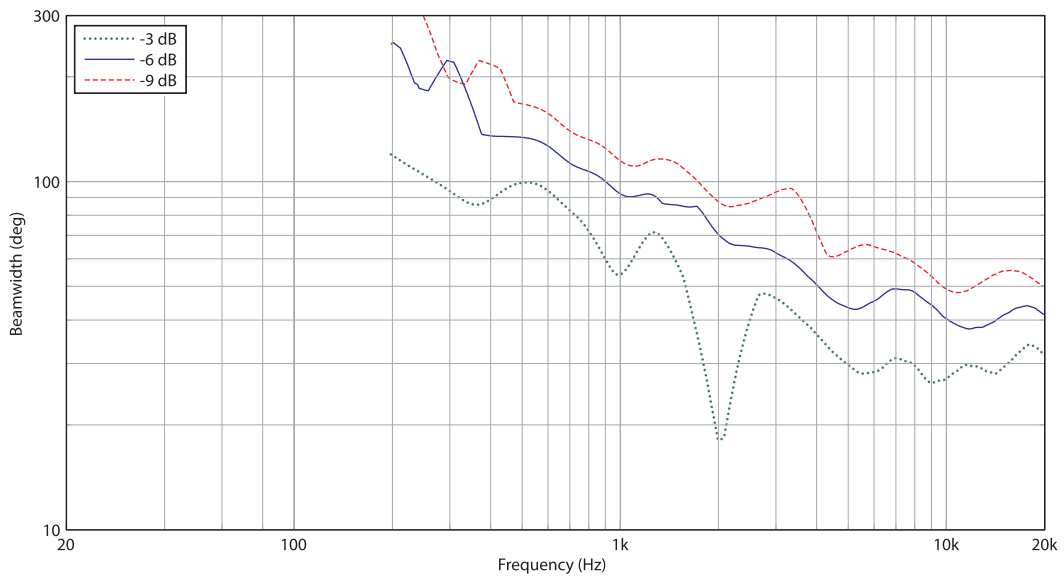

# PERFORMER TPX152

2 Way 15" Full Range Loudspeaker for  
Portable PA Applications

## Horizontal Polar Plots

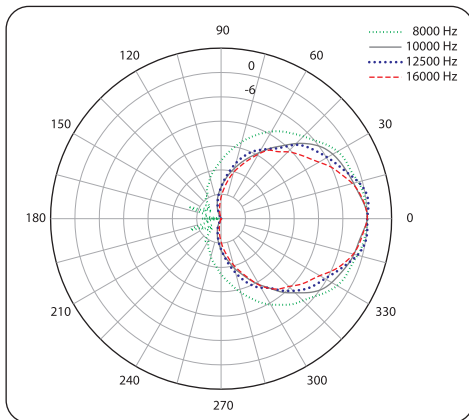
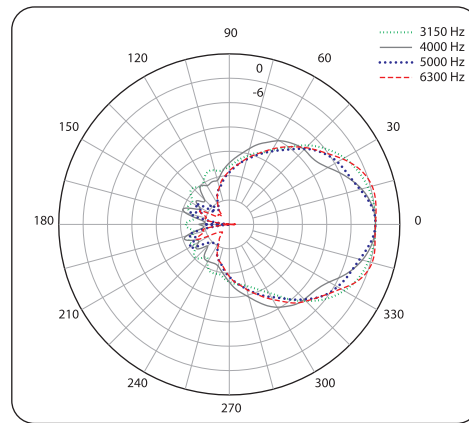
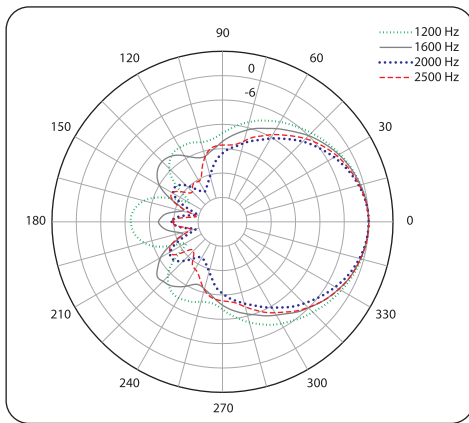
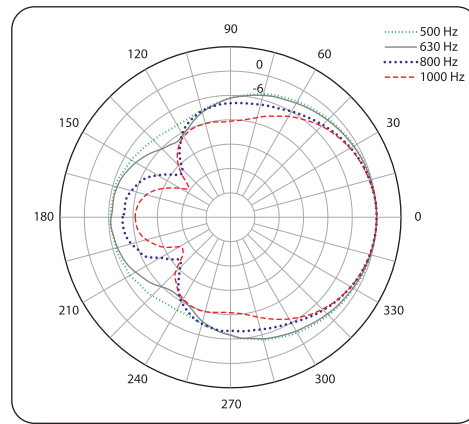
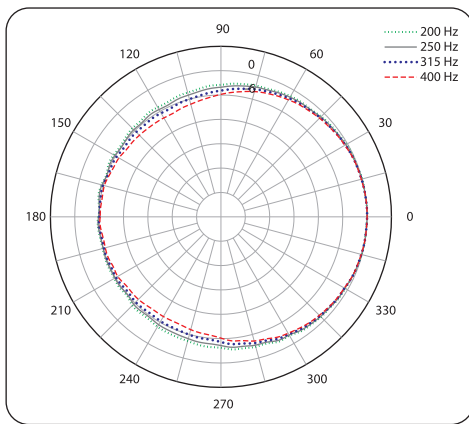

# PERFORMER TPX152

2 Way 15" Full Range Loudspeaker for  
Portable PA Applications

## Vertical Polar Plots

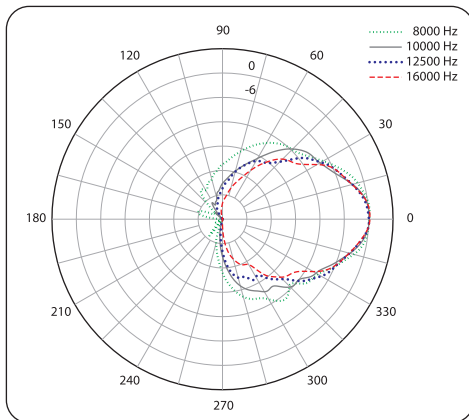
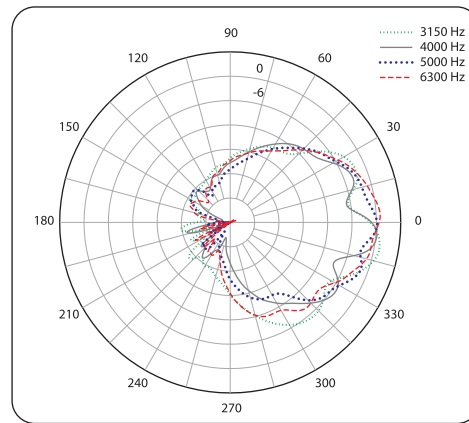
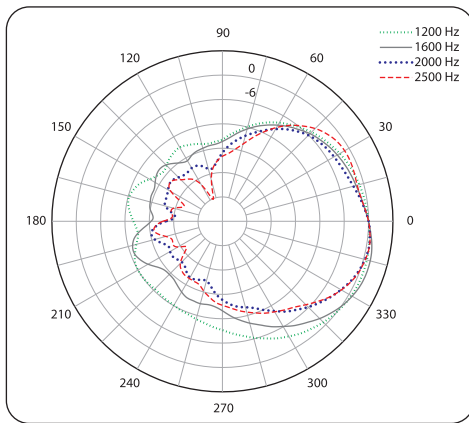
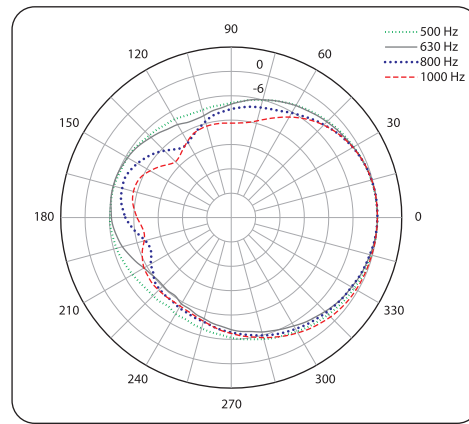
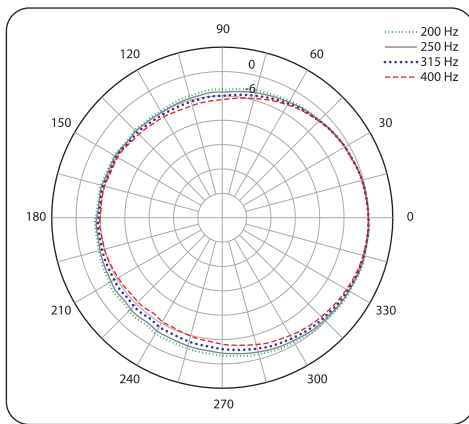

# PERFORMER TPX152

2 Way 15" Full Range Loudspeaker for  
Portable PA Applications

## Dimensions

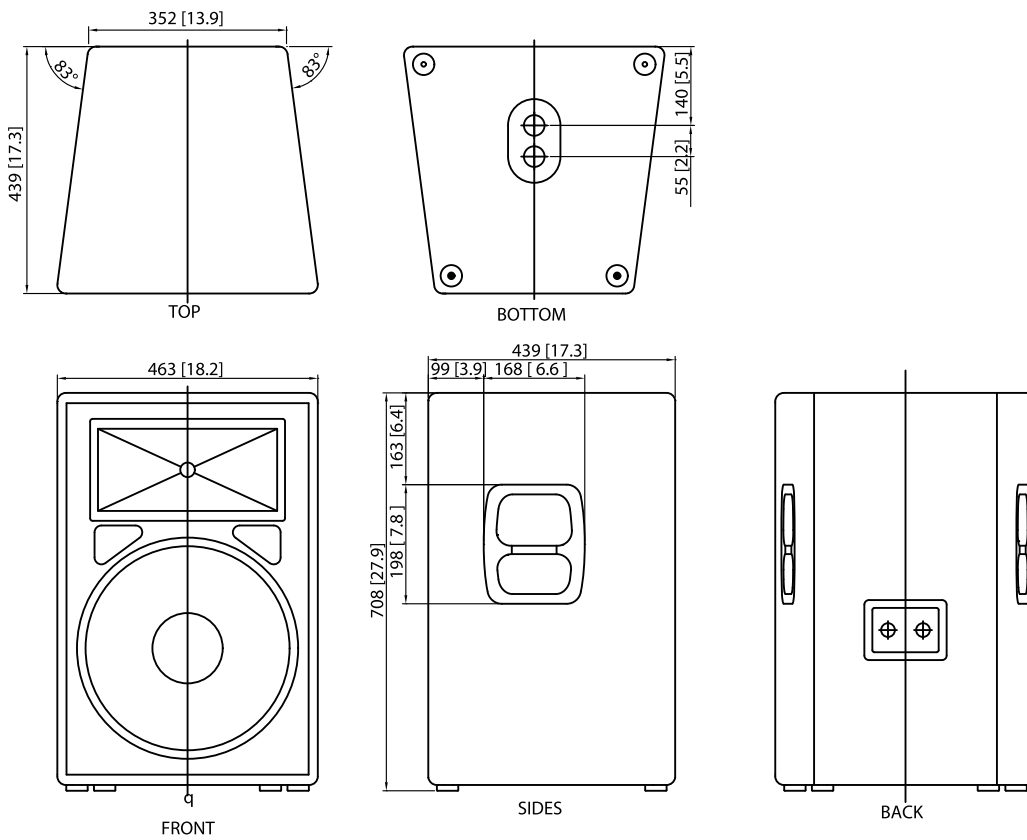

# PERFORMER

## TPX152

2 Way 15" Full Range Loudspeaker for  
Portable PA Applications

### Technical Specifications

#### System

Frequency Response	50 Hz – 20 kHz $\pm$ 3 dB 40 Hz – 20 kHz -10 dB
Nominal Dispersion	70° H x 50° V @ -6 dB points
Power Handling (IEC)	250 W continuous, 1,000 W peak
Sensitivity	97 dB (1 W @ 1 m)
Maximum SPL	121 dB continuous, 127 dB peak
Impedance	8 Ohms
Components	1 x 15" (388 mm) LF driver 1 x 1" (25 mm) HF compression driver

#### Enclosure

Connectors	2 x Neutrik speakON NL4
Wiring	Pins 1+ / 1- input, pins 2+ / 2- link
Dimensions HWD	708 x 463 x 439 mm (27.0 x 18.2 x 17.3")
Net Weight	24.8 kg (54.7 lbs)
Construction	18 mm ( $\frac{3}{4}$ ") particle board
Finish	Black carpet covering
Grille	Powder-coated perforated steel

# PERFORMER TPX152

2 Way 15" Full Range Loudspeaker for  
Portable PA Applications





# PERFORMER TPX152

2 Way 15" Full Range Loudspeaker for  
Portable PA Applications



# PERFORMER TPX152

2 Way 15" Full Range Loudspeaker for  
Portable PA Applications



For service, support or more information contact the TURBOSOUND location nearest you:

**Europe**  
**MUSIC Group Services UK**  
Tel: +44 156 273 2290  
Email: CARE@music-group.com

**USA/Canada**  
**MUSIC Group Services NV Inc.**  
Tel: +1 702 800 8290  
Email: CARE@music-group.com

**Japan**  
**MUSIC Group Services JP K.K.**  
Tel.: +81 3 6231 0454  
Email: CARE@music-group.com

MUSIC Group accepts no liability for any loss which may be suffered by any person who relies either wholly or in part upon any description, photograph, or statement contained herein. Technical specifications, appearances and other information are subject to change without notice. All trademarks are the property of their respective owners. MIDAS, KLARK TEKNIK, LAB.GRUPPEN, LAKE, TANNOY, TURBOSOUND, TC ELECTRONIC, TC-HELICON, BEHRINGER, BUGERA, DDA and TC APPLIED TECHNOLOGIES are trademarks or registered trademarks of MUSIC Group IP Ltd. © MUSIC Group IP Ltd. 2015 All rights reserved.