

asp 800

8 CHANNEL MIC PRE & ADC WITH HMX AND IRON



USER MANUAL V1.2

connect with us.



facebook.com/audient
twitter.com/audientworld
youtube.com/audienthamshire

www.audient.com

Thank you for purchasing this *audient* product!

ASP800 is an audio powerhouse designed to transform your sessions into world class recordings, making it the perfect addition to your audio interface.

ASP800 provides 8 channels of Audient's renowned console mic preamps, class-leading Burr-Brown converter technology, two JFET D.I.'s and two **RETRO** channels with revolutionary tone control.

ASP800 uses a custom power toroid and linear power supply that provides a very low noise floor, and the unit itself is completely silent due to the fanless operation.

RETRO Channels 1 & 2 feature two unique variable harmonic colour controls per channel - **HMX** & **IRON**. Designed to emulate tones often associated with 1960's tube designs and the coveted transformerizing of British audio in the 1970's, HMX & IRON will add new dimension to your audio by providing warm, sparkly tones. Better still, you can combine them to get anywhere in between!

Just plug in your mics, guitars, keyboards and drum machines and you're ready to go, so GET CREATIVE and start thinking BIG!

ASP800 is a great recording tool, but with our new HMX & IRON colouration tools, it also makes a great mixing tool too!

Features include:

- 8 x Superb Class-A mic preamplifiers
- All channels feature -15dB PADS for increased headroom when recording
- All channels feature Combi-XLR inputs with 1/4" TRS Line Inputs available
- 2 x Discrete JFET instrument inputs
- 2 x RETRO Channels with dual stage colour saturation controls - HMX and IRON
- Balanced DB25 analogue line outputs
- Clean & stable 48V Phantom Power on every channel
- 70dB of clean gain split across two gain stages for increased gain bandwidth
- Polarity reverse to enable phase coherent recording on the first two channels - perfect for kick / snare or overheads
- Integrated Burr-Brown PCM4204 ADCs with 116dB dynamic range and SMUX ADAT outputs for 96kHz operation
- Fanless, low noise linear PSU for global operation - 100, 120, 220 & 230V.

Box Contents	1
ASP800 Overview	3
Safety Information	5
Declaration of Conformities	7
Hardware Features:	8
Microphone & Line Inputs	8
Instrument Inputs	9
Input Signal Conditioning	10
RETRO Channels	11
HMX	12
IRON	13
The Triangle of Tone	14
Analogue Line Outputs	15
ADAT SMUX Outputs	15
Setup:	16
Adjusting Levels & Gain	16
Clocking - Internal	17
Clocking - External	18
Clocking Example Systems	19
Specifications	21
Dimensions	22
Block Diagram	23
Trouble Shooting & FAQ	24
Service	25
Warranty & Contact	26
Glossary	27



In your ASP800 packaging you should find the following items:

- ASP800
- Mains IEC Cable
- Quick Start Guide

Please visit:

www.audient.com/products/asp800/downloads to get the latest version of the quick start guide and this manual. Watch/listen to our example video content and grab useful things like a session recall sheet etc.

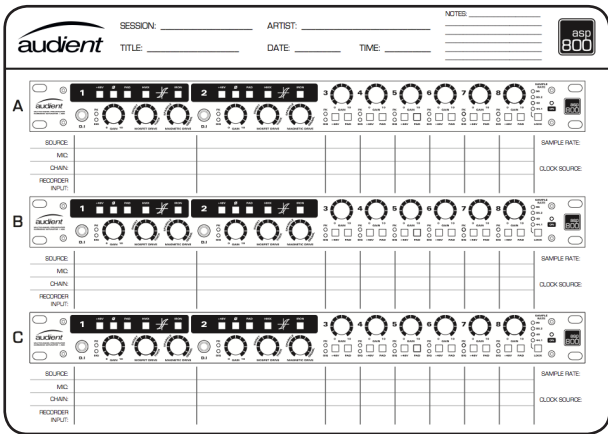

The integrated power supply will accept the main line voltages found around the globe - 100 (Japan), 120 (USA), 220 (China) & 230 (EU/UK) Va.c. To configure the unit please pull out and rotate the fuse holder to the appropriate line voltage for your region.

We hope that you enjoy using ASP800 wherever you are and may it aid you in making great sounding music!



WARNING

PLEASE CHECK FUSE RATING & MAINS VOLTAGE POSITION ON FUSE HOLDER BEFORE CONNECTING THE IEC & POWERING ON THE UNIT.

90-120V_{A.C} = T315MA SLOWBLOW
220-250V_{A.C} = T200MA SLOWBLOW

PULL & ROTATE

PEEL TO REMOVE

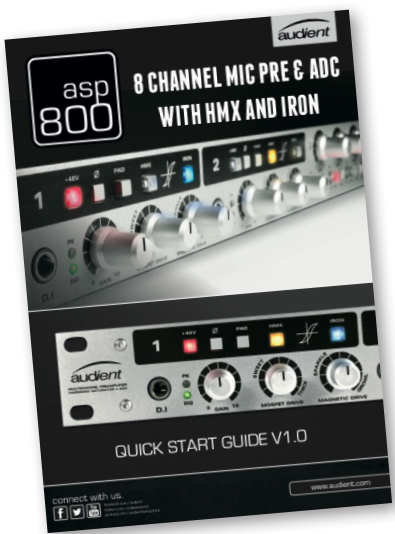

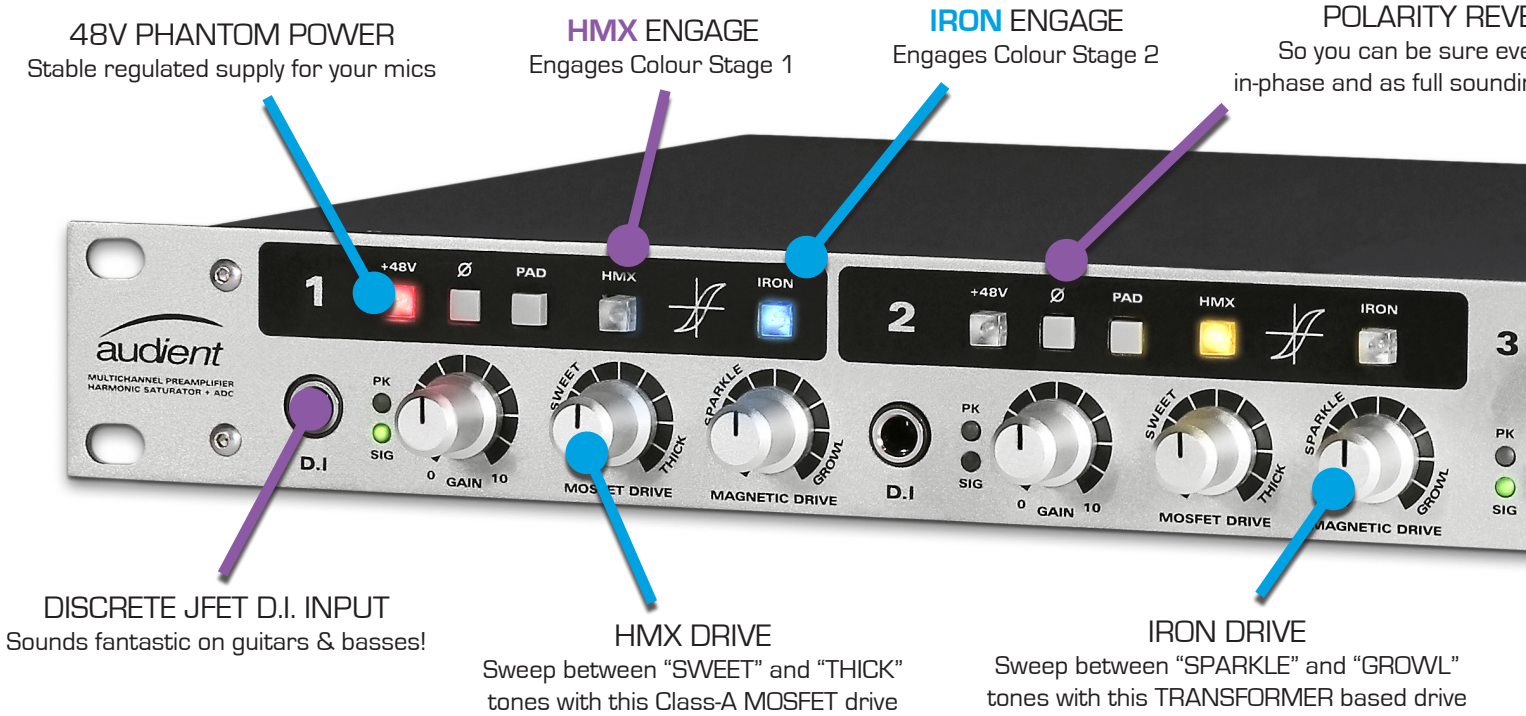

! WARNING !

SWITCHABLE MAINS VOLTAGE & FUSE HOLDER
T200mA (220-250V) or T315mA (90-120V)
(always replace with same type)

DB25 ANALOGUE OUTPUTS
Use to feed the mic preamps into outboard gear or analogue recorders

BNC WORDCLOCK INPUT
Hi-Z or 75Ω Termination available on rear panel switch



MAINS IEC INPUT
Please select your mains line voltage by rotating the fuse holder and lining up the text to the white arrow

75 OHM TERMINATION
Terminates the workclock line at ASP800, when last device in chain

ERSE
 Everything is
 ing as possible

SIGNAL / PEAK METERS
 PEAK = -2dBFS, SIG = -38dBFS

SAMPLE RATE INDICATORS
 Sample rate switch = green when using
 external clock source, toggle through 4 internal
 sample rates and then external sync with LOCK switch



70dB OF CLASS-A GAIN
 Clean, quiet & punchy!

-15dB PAD
 All 8 Channels feature a PAD for
 increased headroom when tracking

POWER INDICATOR

ADC REFERENCE CALIBRATION
 OUT - 0 dBFS = +18dBu (iD22 Professional)
 IN - 0dBFS = +12dBu (iD14 Prosumer)



ADAT SMUX OUTPUTS
 <48kHz = Both Ports (Ch 1-8 Parallel)
 >48kHz = Split Ports (Ch 1-4 and 5-8)

XLR MIC / TRS LINE INPUTS
 Line inputs are available on combi XLR TRS
 jack inputs (padded into the mic pre)

Important Safety Instructions

Please read all of these instructions and save them for later reference before connecting the mains IEC power cable and powering up ASP800. To prevent electrical shock and fire hazard follow all instructions on the rear of the ASP800.



ASP800 does not contain any user serviceable parts inside and in the event of a failure, please contact *audient* support so that we can arrange suitable service.

www.audient.com/support

A 1RU ventilation space above the unit is recommended and it is not advised to run the unit in a rack above hot units such as valve outboard and multichannel AD/DA converters without suitable ventilation space around the unit. Ensure side air vents are not covered.

The linear power supply design features a custom toroidal transformer that will accept any A.C line voltage from 90v to 250v @ 50-60Hz. Therefore the unit will work happily anywhere in the world but you must ensure that the correct voltage is selected via the rotary fuse holder and the fuse itself is correct for your region. Consult a qualified technician if you suspect difficulties. Do not attempt to tamper with the power supply or mains voltages - **HAZARDOUS TO HEALTH**.

! WARNING !

TO REDUCE RISK OF FIRE OR ELECTRIC SHOCK, DO NOT EXPOSE THIS APPARATUS TO RAIN OR MOISTURE.

NO USER SERVICEABLE PARTS INSIDE.

PLEASE REFER SERVICING TO QUALIFIED SERVICE PERSONNEL.

Important Safety Instructions

1. Read these instructions
2. Keep these instructions
3. Heed all warnings
4. Follow all instructions
5. Do not use this equipment near water
6. Clean only with dry cloth
7. Do not block any ventilation openings. Install in accordance with the manufacturer's instructions
8. Do not install near any heat sources such as radiators, heat registers, stoves, or other equipment (including amplifiers) that produce heat
9. Do not defeat the safety purpose of the polarized or grounding-type plug. A polarized plug has two blades with one wider than the other. A grounding type plug has two blades and a third grounding prong. The wide blade or the third prong are provided for your safety. If the provided plug does not fit into your outlet, consult an electrician for replacement of the obsolete outlet
10. Protect power cords from being walked on or pinched particularly at plugs, convenience receptacles, and the point where they exit from the equipment
11. Only use attachments/accessories specified by the manufacturer
12. For products that are not rack-mountable: Use only with a cart, stand, tripod, bracket, or table specified by the manufacturer, or sold with the equipment. When a cart is used, use caution when moving the cart/equipment combination to avoid injury from tip-over
13. Unplug this equipment during lightning storms or when unused for long periods of time
14. Refer all servicing to qualified service personnel. Servicing is required when the equipment has been damaged in any way, such as power-supply cord or plug is damaged, liquid has been spilled or objects have fallen into the equipment, the equipment has been exposed to rain or moisture, does not operate normally, or has been dropped
15. For products that are a mains powered device: The equipment shall not be exposed to dripping or splashing and no objects filled with liquids (such as vases) shall be placed on the equipment



We, Audient Ltd, declare that the product, the ASP800, to which this declaration relates, is in material conformity with the appropriate CE standards and directives for an audio product designed for consumer use.



Audient Ltd has conformed where applicable, to the European Union's Directive 2002/95/EC on Restrictions of Hazardous Substances (RoHS) as well as the following sections of California law which refer to RoHS, namely sections 25214.10, 25214.10.2, and 58012, Health and Safety Code; Section 42475.2, Public Resources



Microphone Preamplifiers & Line Inputs

ASP800 features 8 impeccably optimised Class-A microphone preamplifiers which are the same as the ASP8024, our flagship analogue console for the last 18 years.

Featuring a discrete 8-transistor front end, and an all new 2nd gain stage - the mic pre is optimised for 0 to 70dB gain with an EIN (equivalent input noise) of -127.0 dB. The frontend has high-input headroom and will be happy to accept any level from your microphone collection.

Microphone inputs are provided on the rear panel using Combi XLR connectors - here the 1/4" Combi Jack connector provides a padded balanced line input (input impedance >8k Ω) directly into the mic pre stage (attenuated by 10dB) which is summed into the micpre signal path and offers a great way to integrate keyboards & drum machines etc.

These Combi Jack line inputs run through the mic preamp, providing a slightly sweeter tone (due to the 2nd and 3rd harmonic THD in the mic pre) and have access to POLARITY REVERSE, -15dB PAD as well as **HMX** and **IRON** colouration on RETRO channels 1 & 2.

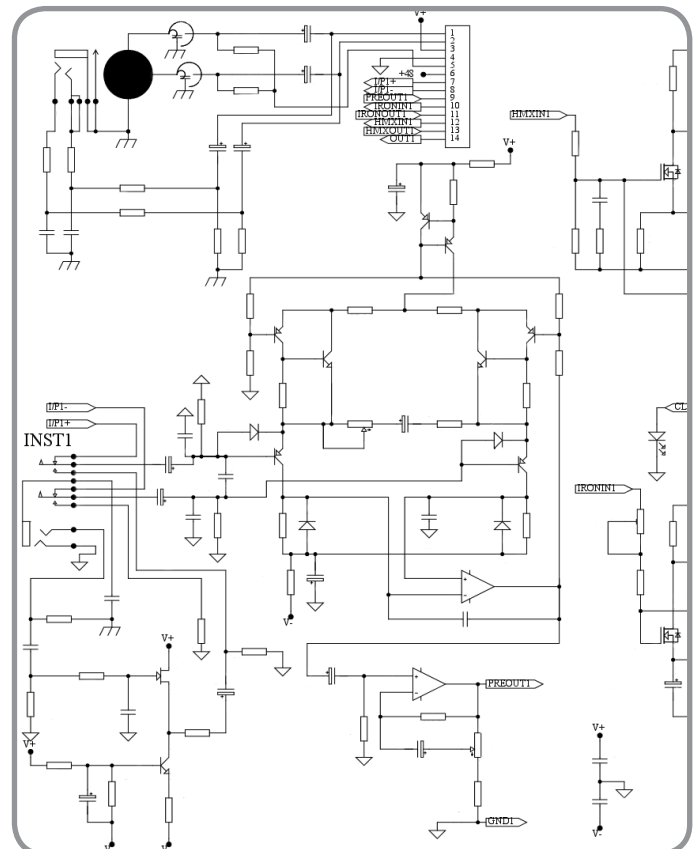

Discrete JFET D.I. (Instrument Inputs)

ASP800 features two discrete Class-A JFET D.I inputs (Channels 1 & 2). Plugging into these jacks will automatically select the D.I signal over the signals present at the rear.

Why JFET?

Junction Field Effect Transistors are known for their sweet tone and tube-like properties when overdriven. You will often find JFETs used in guitar pedals and such for this very reason. They sound good and “can” provide just a touch of sweetness and larger than life tone. JFETs also have a very high input impedance (often approx. $10^{12} \Omega$) and this makes them ideal for buffer circuits that do not load down the source device.

In the case of electric guitars or basses with vintage style passive pickups, the output impedance of the instrument can often be 6,000 to 40,000 Ω , depending upon volume and tone pot positions. Typically we should provide a load that is 10 times the source to create a true bridging system. Therefore we need at least a 400k Ω load to get the most signal and tone from our instruments. It should then come as no surprise that most classic valve guitar amplifiers have a very high input impedance - 1Meg Ω !



**CAPTURE GREAT TONE JUST BY
PLUGGING IN DIRECT!**



We designed the JFET input on ASP800 to have a 1Meg Ω input impedance and thus match the loading effect found on classic guitar amplifiers.

This ensures you get the most tone from your instrument and when pushed the **JFET circuit will provide a touch of 2nd and 3rd harmonic distortion**, and with the option of adding HMX and IRON to your D.I. channels, ASP800 is not short of features that can provide your instrument with some **colour!**

Input Conditioning

In order to correctly condition input signals, ASP800 provides +48V Phantom Power and -15dB PADS on all inputs, as well as polarity reversal on the first two inputs.

1. Phantom Power

Phantom power can be supplied on a per channel basis by pressing the +48V switch. This supplies power to your microphones at $48V \pm 4v @ 10mA$ per channel and is suitable for any phantom powered condenser mics, or ribbons with on-board active head amps etc.

2. Ø Polarity Reverse

Polarity reverse (180 degrees) can be applied on the RETRO channels to ensure that multi-mic setups sound as full as possible.

ALWAYS REMEMBER TO CHECK PHASE.

3. -15dB PAD

Each channel on ASP800 features a -15dB attenuator, designed to maintain source and load impedances and offer an inaudible attenuator from a tonal point of view. Reducing the signal level from very hot microphones by 15dB will provide immense headroom when tracking loud sources.

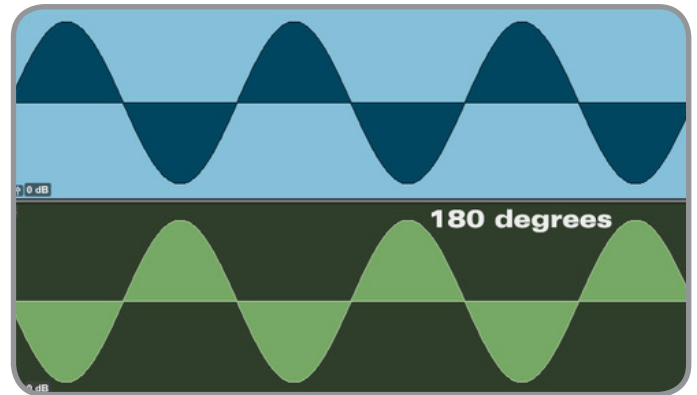

180 degrees out of phase = cancellation

Checking Phase

To check phase coherency on multi-mic setups, first always use careful microphone placement and then press the Ø switch on the channels to find the fullest, most solid low frequency representation of the source.

On drum kit recordings typically you may find either the kick drum out of phase with the overheads, or the underneath snare mic out of phase with the top snare mic etc, so move mics first and then use the polarity reverse switch to find the best compromise.

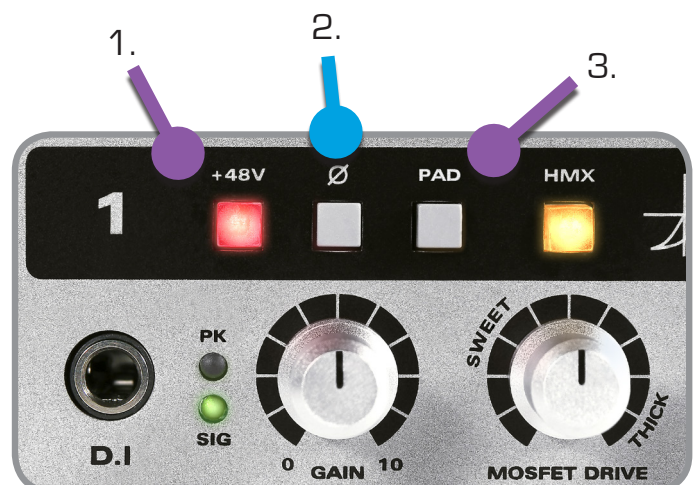

HMX

HMX uses discrete, Class-A MOSFET circuitry to produce smooth, musical distortion.

HMX is an asymmetrical saturation stage reminiscent of valve saturation but has also been voiced to produce some heavy low frequency waveshaping and subtle frequency response shifts that look very similar to tape head bump [+2.5dB @ 50Hz].

HMX offers very high levels of 2nd to 4th harmonic distortion and is prominent in even order harmonics for a rich, larger than life sound.

The HMX knob allows control over the amount of distortion added but it also compensates for added level during the drive phase, therefore enabling accurate A/B comparison without perceived loudness bias.

HMX loves bass! Try it out when mixing too!

IRON

IRON uses a custom made British 1:1 600Ω transformer with a discrete Class-A MOSFET drive network to create symmetrical harmonic distortion reminiscent of magnetic tape distortion.

Using IRON MAGNETIC DRIVE provides a low frequency saturator, along with a subtle transient smearing effect that adds punch similar to hysteresis in magnetic tape.

IRON like all transformers exhibits phase shift at the audible extremes and as is the case in many of the British 1970's classics, a subtle boost in the high frequencies from 4 to 15kHz, smoothly rolling off towards 30kHz - which adds dimension and that "*sounds like a record*" top end!

IRON loves transient information - FEED IT!



IRON uses a 1:1 custom transformer

HMX - Colouration Stage 1

HMX creates lots and lots of musical distortion. Described as THD (total harmonic distortion) - we see a fundamental signal stimulating the stage into saturation and the output adding 2nd, 3rd & 4th harmonics predominantly. These are equivalent to a musical octave up, an octave & a fifth and an octave & a perfect fourth. All musically related and not dissonant. Therefore, HMX sounds **FAT, MUSICAL & LARGER THAN LIFE**.

HMX also uses pre and de-emphasis filtering to bump up low frequency colouration - and this is part of the reason why it loves bass, 808 and bass synth so much! The three Class-A gain stages saturate in series to provide smooth asymmetrical distortion that has been sweetened at each stage.

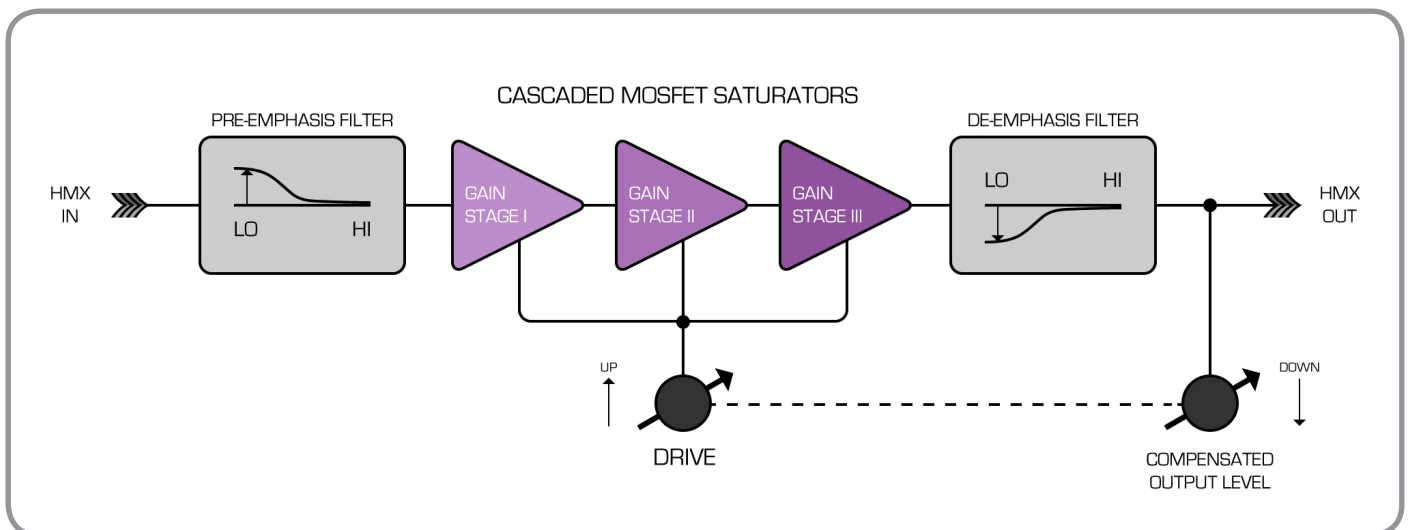
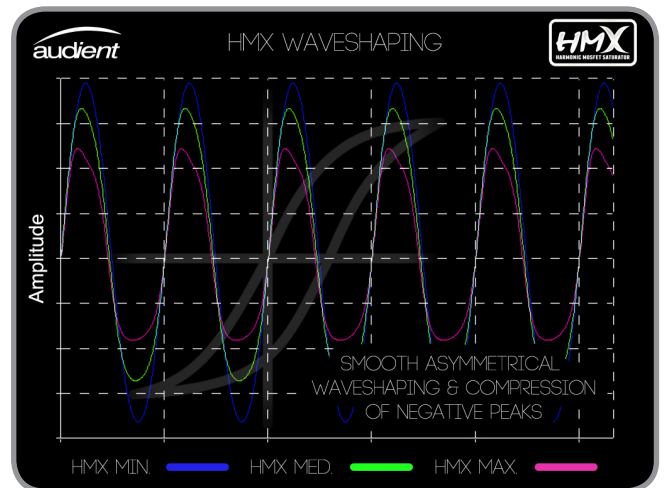
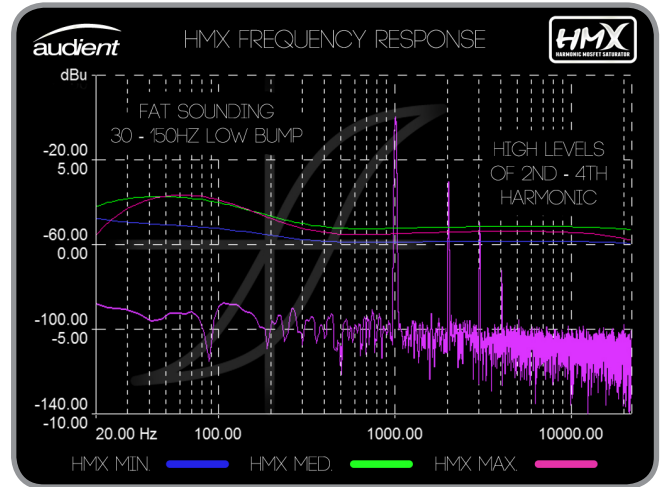

IRON - Colouration Stage 2

IRON utilises a magnetic core to create a number of non-linear effects that have helped shaped the sound of classic 1970's equipment. These include:

- Transient shaping due to magnetic hysteresis (memory effect where the core stores energy)
- Low frequency saturation due to the magnetic core of the transformer filling up with magnetic energy
- Phase shift & airy frequency response changes caused by resonances within the core and incorrect damping
- IRON also uses two discrete Class-A MOSFET amplifiers that provides “sloppy” drive to the core and gain recovery after magnetic saturation. Both of these stages add their own sweet harmonic distortion to create the special sauce!

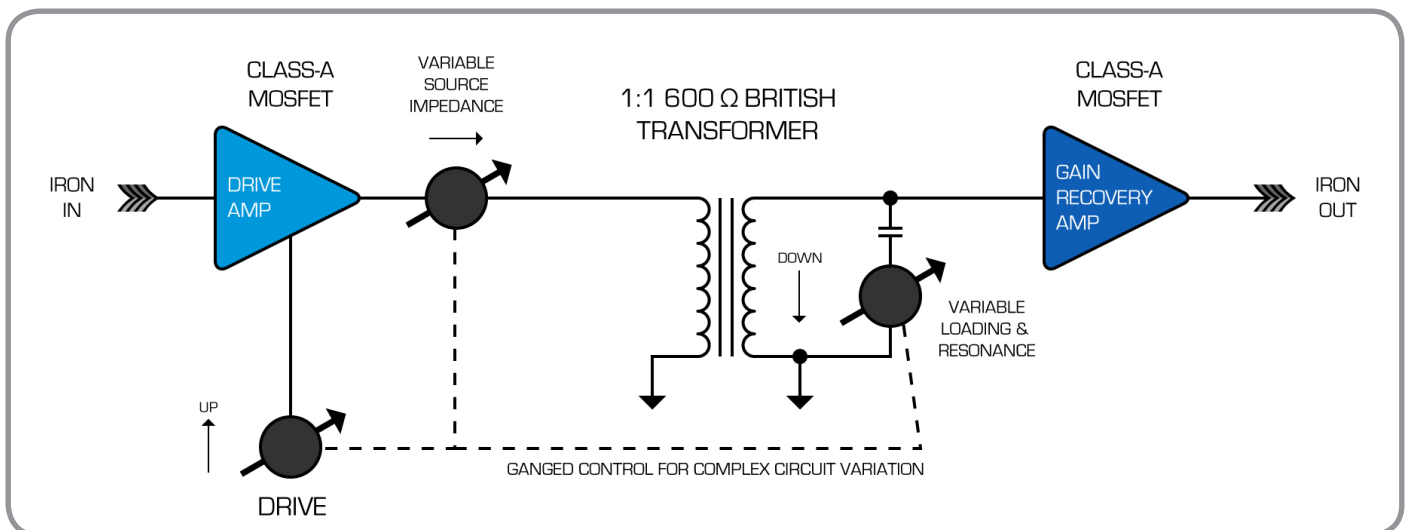
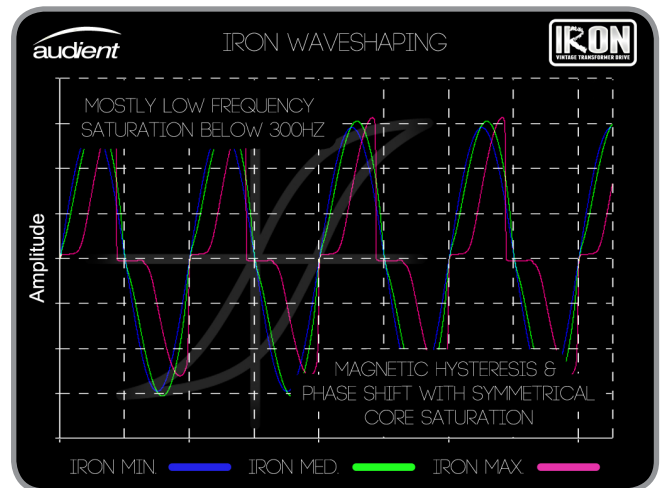
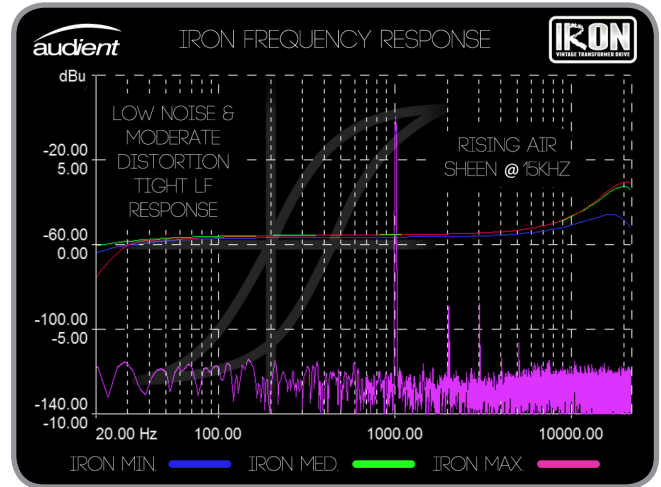

The Triangle of Tone

Combining **HMX** & **IRON** provides ASP800 with the tonal ability to shape the source and move around THE TRIANGLE OF TONE. This method of mapping the colouration allows you to voice the neutral preamp towards THICK/SLOW, HARD/PUNCHY or anywhere in between. A powerful tool for both recording & mixing via the mic / line inputs!

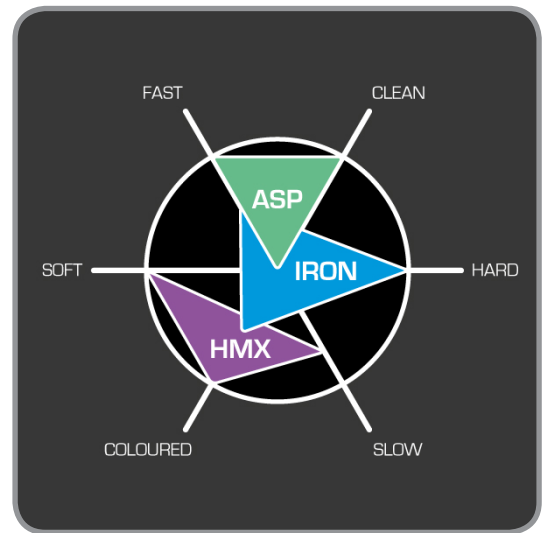

FAT 808 DRUMS



ACOUSTIC GUITAR SPARKLE



EXTRA KICK THUMP



MORE SNARE ATTACK



BASS GUITAR GROWL



LEAD VOCAL AIR



Analogue DB25 Line Outputs

ASP800 features 8 analogue, ground sensing line driver outputs on DB25. These fully balanced outputs use the same sense circuitry as our proven ASP8024 flagship console (insert sends etc) and offer a simple, yet elegant output stage for driving into whatever analogue destination you are feeding, such as a standalone A-D converter or analogue mixing console.

These outputs are wired as Tascam DB25 standard with $<200\Omega$ output impedance and +22dBu maximum level.

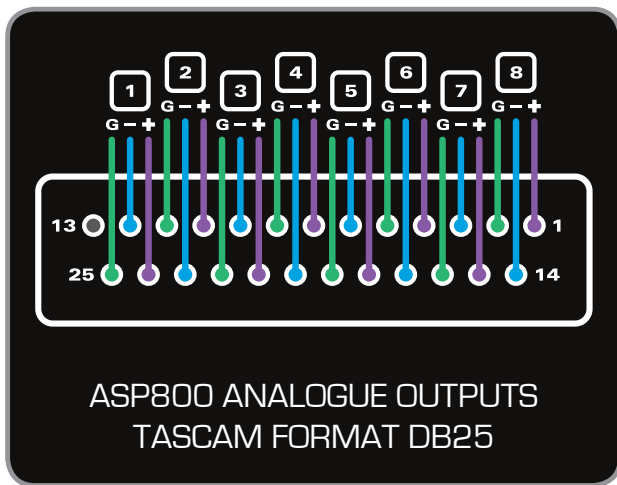

Digital Output - ADAT SMUX

The digital card also provides simultaneous ADAT optical output on the rear of the unit with full SMUX double speed capability. For 44.1 or 48kHz operation, a single optical cable should be connected to either ADAT ports. This will provide all 8-channels on a single port, and you can use both ports at the same time for redundant recording. For 88.2 or 96kHz operation, two optical cables should be used for full 8 channel operation, with four channels carried on each.

0 dBFS ADC Calibration

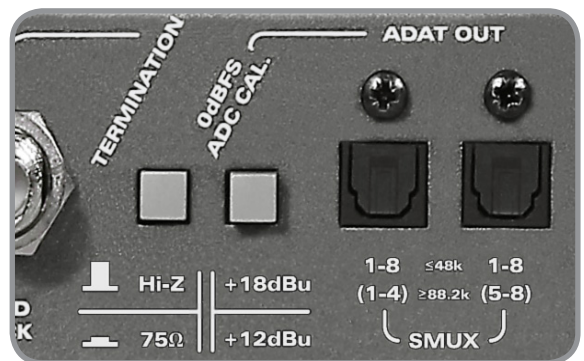

This switch changes the converter reference level so that 0dBFS = +12dBu or +18dBu. This feature is provided to match the input level to that of your audio interface. For example, if using ASP800 with one of our own interfaces you should set it as follows:

Audio Interface	0 dBFS Reference
iD22 (Professional)	+18 dBu
iD14 (Prosumer)	+12 dBu

Setting Levels & Gain

ASP800 has plenty of analogue headroom, running internally on +/-15V DC rails.

The unit can deliver up to +22dBu at the analogue output DB25 on the rear of the unit. Which is enough to drive most standalone A-D converters into full scale overload.

However it would be typical in modern digital recording situations that ASP800 is using our own internal pristine 116dB ADC converters to produce a digital output for recording via the built-in ADAT digital output.

In this case, the ASP800 has a variable digital line-up reference of +18dBu or +12dBu = 0dBFS (full scale), which you can select depending upon the line-up level of your interface and whether you have the 0dBFS ADC Calibration switch engaged. (see page 15).

As a target guide, we would recommend that you turn up the ASP800 gain pots to produce a -10dBFS peak signal level in your DAW when recording. This will maintain plenty of headroom which often makes things sound better. To do this, adjust the gain knob on ASP800 whilst observing the metering in your interface or DAW application.

AIM FOR -10DBFS PEAKS ON THE LOUDEST SECTIONS WHEN SETTING GAIN & RECORDING LEVELS IN THE DAW!



The LED metering on the ASP800 will show signal present at -38dBFS with a peak LED warning of potential overloads at -2dBFS. However please rely upon the recording destination for accurate metering, ideally you should never be so close to light the PEAK LED!

Clocking with the ASP800

There are two ways to integrate ASP800 into your system digitally:

- As a **MASTER** clock source - internal clock
- As a **SLAVE** device - external clock

Master Clock Operation (INTERNAL)

Assuming that you are connecting the ASP800 digital output to a DAW/recording interface with ADAT inputs, the ASP800 can be set as **MASTER** clock source as follows:

Select the appropriate sample rate on the front of ASP800 by pressing the **SAMPLE RATE** switch [1]. The selected internal clock sample rate will be displayed by the YELLOW LEDS - 44.1, 48, 88.2 or 96kHz.

Ensure that your DAW / recorder session is set to the same sample rate and that the clock source is set to external digital ADAT input to allow your downstream device to receive master clock from ASP800s ADAT output..Your DAW / recorder should automatically follow the sample rate set on the front of the ASP800.



1.

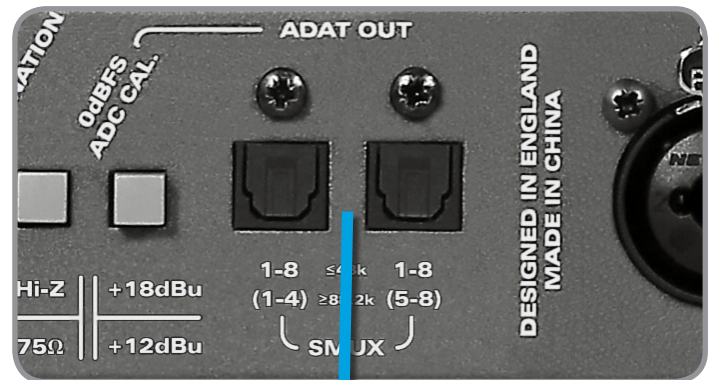

CONNECT DIGITAL ADAT OUTPUT TO YOUR INTERFACE/RECORDER

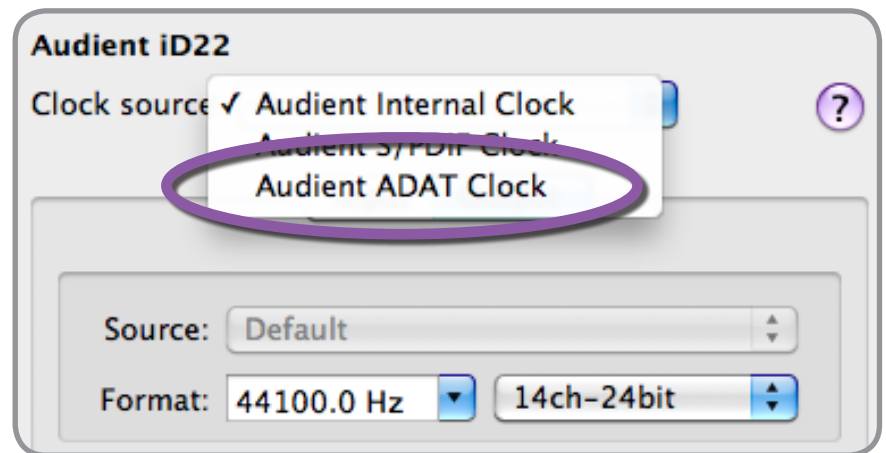

Slave Clock Operation - EXTERNAL

You may have a studio master clock source such that all digital devices synchronise to your session sample rate, or perhaps you would like the ASP800 to follow your DAW / recorder session sample rate so that you do not have to reconfigure the unit when you flip between sessions at different sample rates.

In order to do this, you must set the ASP800 digital card to **SLAVE** to an external clock source.

Press the **SAMPLE RATE** switch (1) until it is flashing green (external clock mode).

Ensure that your master clock source is connected via a 75Ω coaxial BNC cable to the Word Clock input on ASP800 (3) - with a valid clock signal present here, the green LED in the **SAMPLE RATE** switch should become solidly lit, indicating external lock.

If ASP800 is the only or last device in the clock chain fed from the master clock, go ahead and press the 75Ω termination switch (2) to ensure that the clock line is loaded properly to stop any transmission line effects.

If using a BNC T-Bar to distribute clock signals to various devices - please ensure the last device in the chain is terminated (75Ω).



1.
MASTER CLOCK SOURCE
BNC OUTPUT to ASP800
WORD CLOCK INPUT

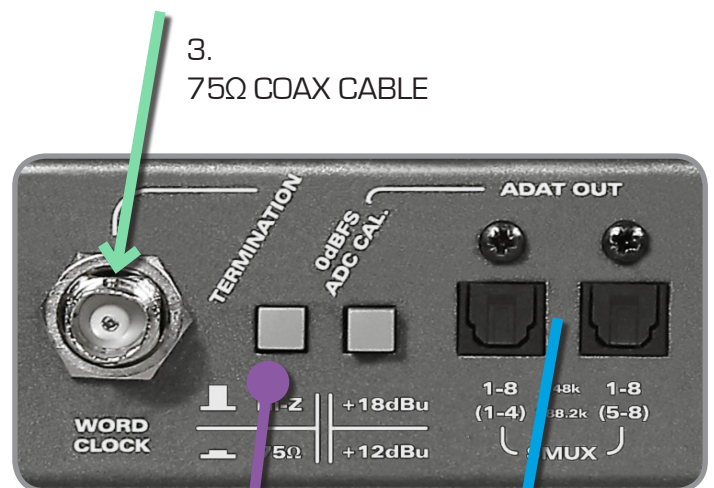

2.
3.
75Ω COAX CABLE
CONNECT DIGITAL OUTPUT (ADAT)
TO YOUR DAW/RECORDER



SLAVE



SET DAW SESSION SAMPLE RATE TO MATCH ASP800 MASTER.

ALSO ENSURE iD14 IS SET TO EXTERNAL ADAT CLOCK IN iD APPLICATION & YOUR OPERATING SYSTEM

MASTER



ASP800 ADAT OUTPUT TO iD14 ADAT INPUT

SELECT MASTER SAMPLE RATE BY PRESSING THE LOCK SWITCH TO CYCLE THROUGH FOUR AVAILABLE SAMPLE RATES 44.1 to 96kHz



CLOCKING CONFIGURATION - ASP800 (MASTER) & iD14 (SLAVE)

MASTER

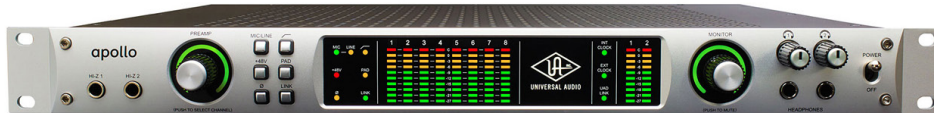

SET DAW SESSION SAMPLE RATE & MASTER CLOCK SAMPLE RATE IN DAW & UA APOLLO

ASP800 ADAT OUTPUTS TO APOLLO ADAT INPUTS

APOLLO BNC CLOCK OUT TO ASP800 CLOCK INPUT

TERMINATE BNC WITH 75Ω

PRESS LOCK UNTIL FLASHING GREEN - WILL TURN SOLID ONCE LOCKED TO EXTERNAL SOURCE ON BNC

SLAVE



CLOCKING CONFIGURATION - UA APOLLO (MASTER) & ASP800 (SLAVE)

MASTER



TERMINATE BOTH BNCs WITH 75Ω IF SINGLE POINT CONNECTION TO EACH ASP800

ASP800 ADAT OUTPUTS TO ORION³² ADAT INPUTS

IF USING A MASTER CLOCK WITH SINGLE BNC OUTPUT, EITHER USE A T-BAR AND TERMINATE PARALLEL DEVICES, OR USE A DAISY CHAIN ARRANGEMENT AND TERMINATE THE LAST DEVICE IN THE CHAIN AT 75Ω

SLAVES



PRESS LOCK ON BOTH ASP800 SLAVES UNTIL FLASHING GREEN - WILL TURN SOLID ONCE LOCKED TO EXTERNAL SOURCE ON BNC



CLOCKING CONFIGURATION - ANTELOPE ORION32 (MASTER) & 2 x ASP800 (SLAVES)

MASTER



TERMINATE LAST DEVICE IN DAISY CHAIN AT 75Ω

ASP800 ADAT OUTPUTS TO ORION³² ADAT INPUTS

USE A T-BAR TO CREATE A DAISY-CHAINED ARRANGEMENT - TERMINATING THE LAST DEVICE IN THE CHAIN AT 75Ω

SLAVES



PRESS LOCK ON BOTH ASP800 SLAVES UNTIL FLASHING GREEN - WILL TURN SOLID ONCE LOCKED TO EXTERNAL SOURCE ON BNC



CLOCKING CONFIGURATION - ANTELOPE ORION32 (MASTER) & DAISYCHAIN (SLAVES)

MICROPHONE PREAMPLIFIER:

(measured to balanced DB25 analogue outputs)

MIC GAIN:	0 to 70 dB [extra gain stage for more!]
SWITCHABLE PAD:	-15 dB [all channels front panel switchable]
LINE GAIN:	-10 to 60 dB [-25 to 45 dB inc. PAD]
PHANTOM POWER:	48V ±4V @ 10mA / channel
MIC EIN:	<-127.0 dBu
CMRR:	>80 dB @ 100Hz to 2kHz
MAXIMUM INPUT LEVEL:	+20 dBu [+35 dBu with PAD]
INPUT IMPEDANCE (Mic):	>2kΩ balanced [approx. 2.2kΩ]
INPUT IMPEDANCE (Line):	>8kΩ balanced [approx. 8.6kΩ]
FREQUENCY RESPONSE:	±0.5 dB 10Hz to 100kHz @ min. gain
CROSSTALK:	<-90 dBu 10Hz to 10kHz
THD+N @ 0dBu (1kHz):	<0.003% [-90.5 dBu] mostly 3rd harmonic
SNR:	>90 dB @ min. gain
XLR COMBI FEMALE:	Pin 2 (Hot), Pin 3 (Cold) & Pin 1 (Shield)
1/4" TRS JACK:	Tip (Hot), Ring (Cold) & Sleeve (Shield)

DISCRETE JFET D.I.:

(measured via microphone preamplifier circuitry)

D.I GAIN:	0 dB unity gain (0 to 70 dB)
MAXIMUM INPUT LEVEL:	+17 dBu
INPUT IMPEDANCE (D.I.):	1Meg Ω unbalanced
FREQUENCY RESPONSE:	±0.5 dB 10Hz to 50kHz
THD+N @ 0dBu (1kHz):	<0.01% [-80 dBu] mostly 2nd & 3rd
SNR:	>85 dB @ min. gain
1/4" TS JACK:	Tip (Hot) & Sleeve (Shield)

BALANCED ANALOGUE LINE OUTPUTS:

(ground sensing compensation scheme)

MAXIMUM OUTPUT LEVEL:	+22 dBu
OUTPUT IMPEDANCE:	<200Ω ground sensing <100Ω unbalanced
8-CHANNEL DB25:	25-Pin Tascam Format

HMX MOSFET SATURATOR:

THD+N @ 0 dBu Min. Drive (1 kHz):	0.35% (2nd & 3rd only)
THD+N @ 0 dBu Max. Drive (1 kHz):	2.73% (2nd to 4th dominate)
NOISE @ Min. Drive	-73 dBu [like an old tube amp!]
FREQUENCY RESPONSE:	30 to 150Hz low frequency emphasis bump - see below
WAVESHAPING:	Asymmetrical Tube-like soft clipping

HMX offers a valve (tube) like soft clipping that is pre and de-emphasised with passive filtering to achieve a fat low frequency response with a softened midrange. It uses three cascaded MOSFET class-A amplifiers to reach high levels of musical distortion, but the output level is always held constant so your ears are not biased by loudness. Some extra noise will act as a nice analogue dither when inside the DAW, why use a plugin to add analogue modeled noise when you can have the real thing?!

WEIGHT: 4.5 kg

A-D CONVERTER:

(measured under AES-17 sans microphone preamplifiers)

CHIPSET:	Burr-Brown PCM4204 24-bit PCM
DIGITAL REFERENCE LEVEL:	Selectable via Rear Panel 0 dBFS = +18 dBu (iD22 Professional) 0 dBFS = +12 dBu (iD14 Prosumer)
FREQUENCY RESPONSE:	±0.1 dB 20Hz to Fs/2 (Nyquist)
CROSSTALK:	<-110 dBFS @ 1kHz & <-90 dBFS @ 10kHz
THD+N @ -1 dBFS (1kHz):	0.0015% [-96.5 dB]
THD+N @ -6 dBFS (1kHz):	0.0009% [-101 dB]
DYNAMIC RANGE:	113.5 dB un-weighted 116.0 dB A-weighted
PEAK LED LINEUP:	-2 dBFS [moves with reference level]
SIGNAL LED LINEUP:	-38 dBFS [moves with reference level]

DIGITAL OUTPUT:

ADAT 8 CHANNEL SMUX:	44.1 to 96.0 kHz
CLOCK:	Internal Crystal or External Source
WORDCLOCK INPUT:	75Ω BNC - switchable 75Ω termination

POWER SUPPLY:

LOW NOISE SHIELDED LINEAR PSU	CUSTOM TRANSFORMERS
FANLESS, QUIET OPERATION:	35W Maximum Consumption
INTERNAL D.C POWER RAILS:	±15V, +48, +32V & +9V
SWITCHABLE MAINS VOLTAGE:	100, 120, 220 or 230Va.c
FUSE:	T200mA (UK) or T315mA (US) Time Delay (T) Slow-Blow Type

IRON TRANSFORMER SATURATOR:

THD+N @ 0 dBu Min. Drive (1 kHz):	0.11% (2nd & 3rd mostly)
THD+N @ 0 dBu Max. Drive (1 kHz):	0.006% [cleans up as driver load changes]
THD+N @ L.F (<300 Hz):	Complex variance with level and frequency - distorts bass content
NOISE @ Min. Drive	-84 dBu [like a 2" tape machine]
FREQUENCY RESPONSE:	4k to 15kHz rising air boost / resonance - see below
WAVESHAPING:	Symmetrical / Magnetic Loop Transient Shaping & Phase Shift

IRON provides a complex variable effect with one simple control that can shift phase, tighten sub frequencies, slew transients and distort low frequencies with symmetrical magnetic core saturation. There is also a small amount of asymmetrical saturation present in the drive & recovery amplifiers for a very complex but subtle palette of tone!

The frequency response has an air boost present that is manipulated with secondary loading of the 1:1 transformer to replicate the magic of the 70's, adding the smooth, zingy air to high frequencies that can add to perceived depth in the top end. Combine with HMX for big tone from ASP800.

DIMENSIONS:

1RU
482mm x 286.5mm x 44mm

DIMENSIONS

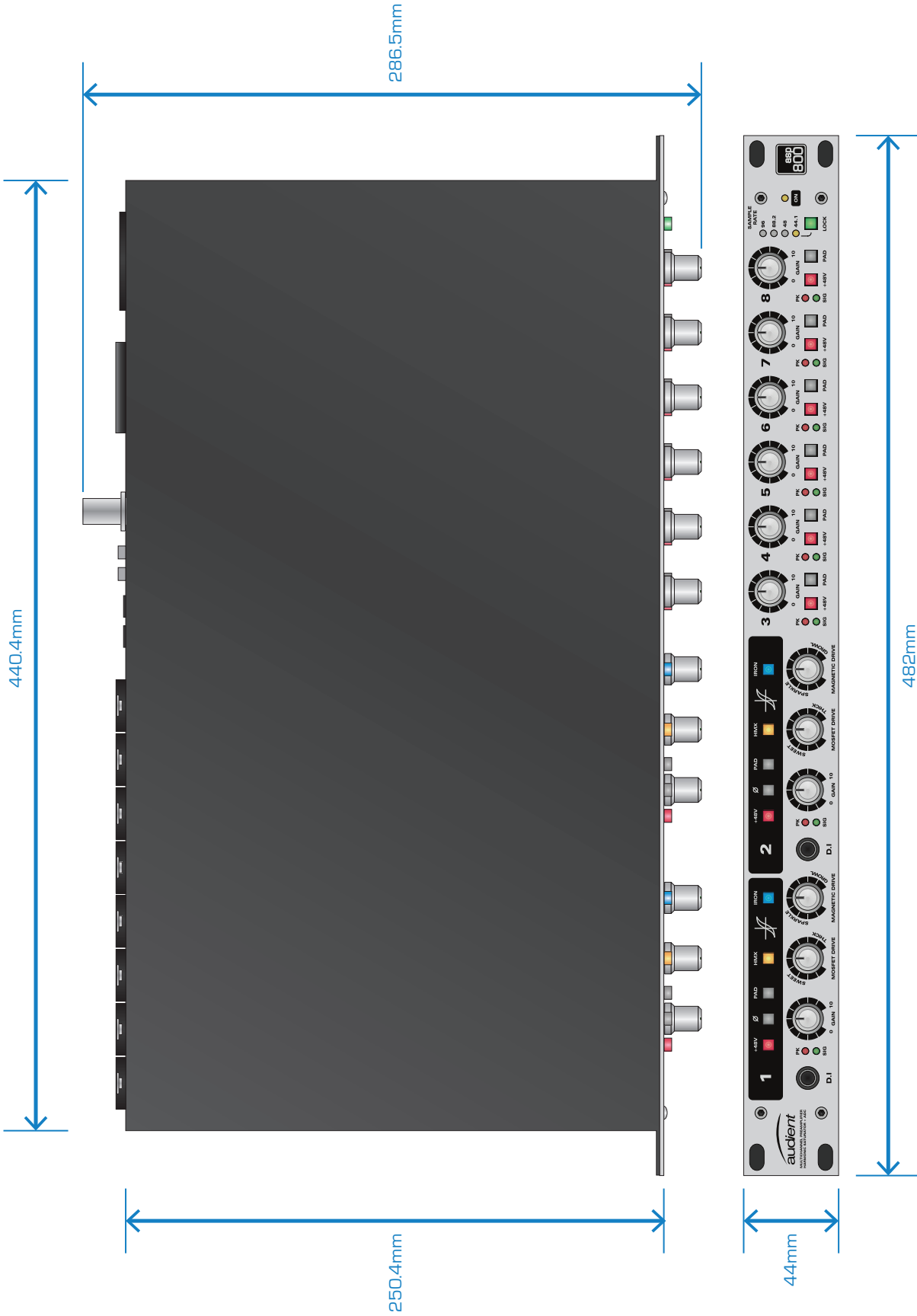

CHANNEL 1 & CHANNEL 3 SHOWN ONLY
 CHANNEL 2 AS CHANNEL 1 WITH DJ INSTRUMENT INPUT, HMX & IRON
 CHANNELS 4-8 AS CHANNEL 3 WITH NO DJ, HMX & IRON

CH1 & CH2 RETRO CHANNELS

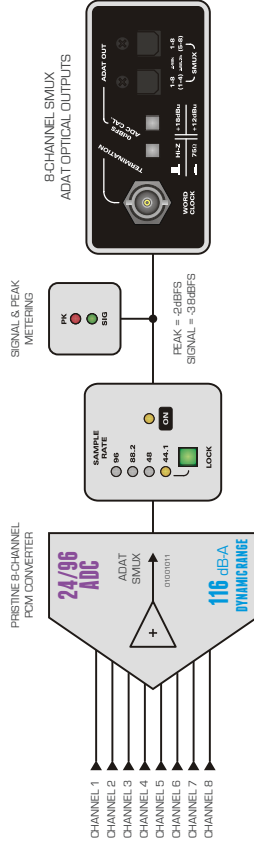
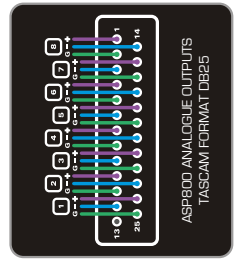
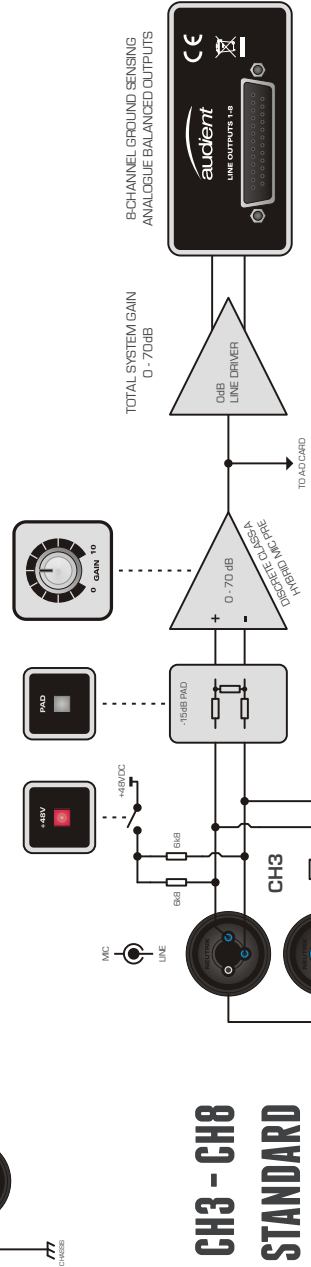
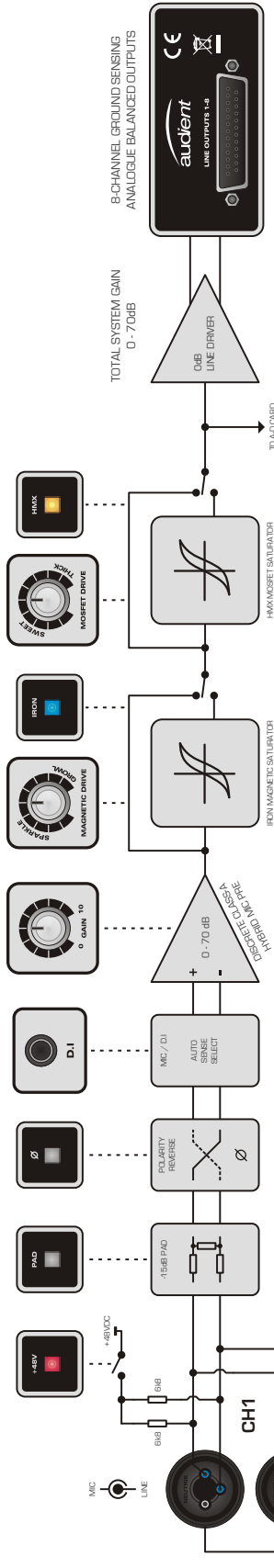

**BUILT-IN
 BURR-BROWN
 PCM4204 ADC**

CH3 - CH8 STANDARD CHANNELS

ASP800 BLOCK DIAGRAM

Troubleshooting

- [My microphones are not producing signal?](#)

If required, double check that phantom power is turned on via the front panel switch, try swapping XLR cables, then double check all connections to the recorder / interface.

- [Cannot clock the ASP800 from an external clock source, or you are experiencing clicks & pops?](#)

Double check that you have set the clock source to external by using the front panel **SAMPLE RATE** switch, press it until it is flashing green. This selects external clock mode and the unit is ready to accept an incoming clock source via the BNC input.

From here, double check your master clock source, and ensure it is connected via a 75Ω BNC coaxial cable to the ASP800 BNC wordclock input.

Providing that you have a valid clock source, ASP800 should sync to it without issue and the **SAMPLE RATE** led in the switch will turn to solid illumination. This shows that the unit is locked. If you experience pops & clicks - double check any master/slave device configurations and cabling. **A system should only have one master clock.**

FAQs

For more information and service information / support, please search our online [Help Centre](#) which can be found here:

www.audient.com/support

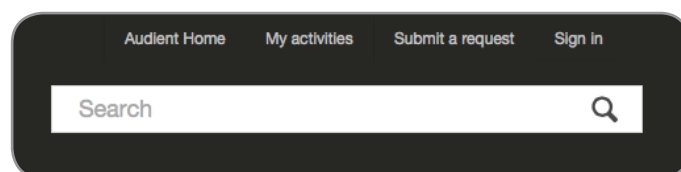

For technical support please create a ticket in our online support system, Zendesk which can also be found in the support section of our website (see link above).

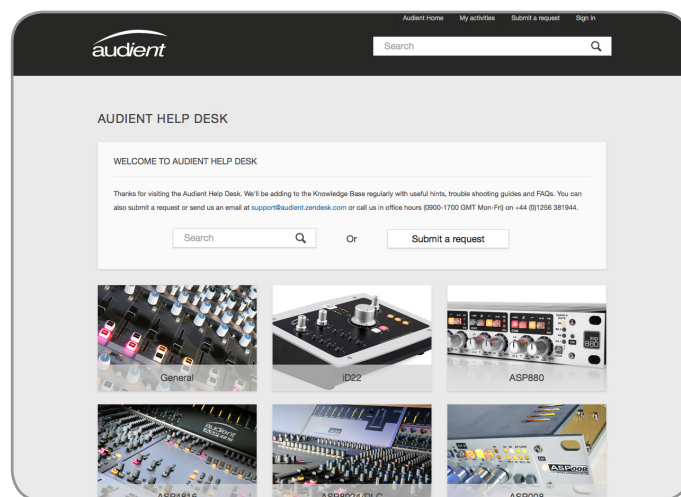

Please consult the warranty statement on page 27 for further information regarding service requirements and our policies.

Service Information

ASP800 contains no user-serviceable components, please refer to qualified service personnel for diagnosis and repair. Your warranty will be void if you tamper with the device at component level. If you have any questions with regard to the repair, please contact Audient Ltd.

In the event your ASP800 needs to be repaired, it is necessary to contact Audient Ltd prior to shipping, and a [Return Materials Authorization](#) (RMA) number will be assigned. This number will serve as a reference for you and helps facilitate and expedite the return process. When the unit is returned please include this RMA number along with a description of the fault inside the packaging box. Audient requires that shipments be pre-paid (for in-warranty repairs we will cover the return shipping).

To request an RMA, access technical support & FAQs, ask for troubleshooting assistance or make an enquiry, please visit: www.audient.com/support

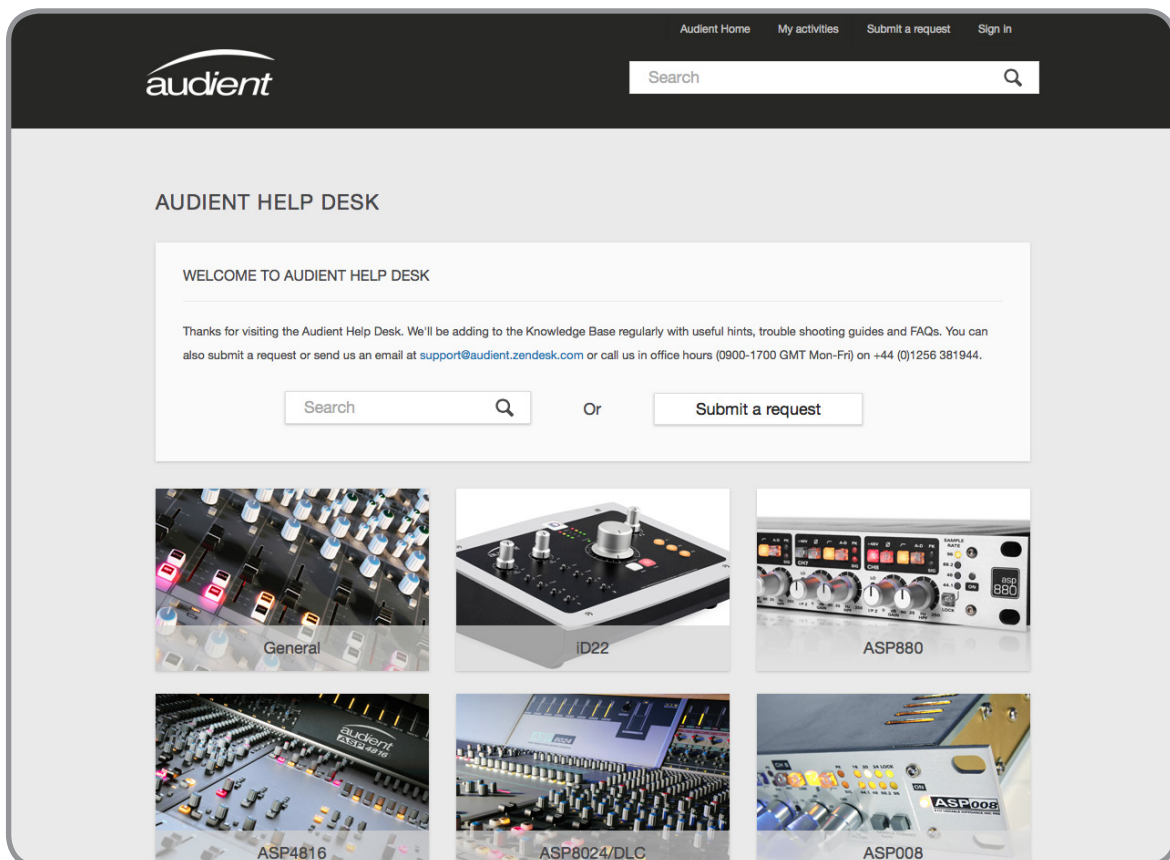

Warranty Statement

Your ASP800 comes with a manufacturer's warranty for one year (12 months) from the date of despatch to the end user.

The warranty covers faults due to defective materials used in manufacture and faulty workmanship only.

During the warranty period *audient* will repair at its discretion or replace the faulty unit provided it is returned carriage paid to an authorised *audient* service centre. We will not provide warranty repair if in our opinion the has resulted from unauthorised modification, misuse, negligence or accident.

We accept liability to repair or replace your ASP800 as described above. We do not accept any additional liability. This warranty does not affect any legal rights you may have against the person who supplied this product - it is additional to those rights.

Warranty Limitations

This warranty does not cover damage resulting from accident or misuse. The warranty is void unless repairs are carried out by an authorised service centre. The warranty is void if the unit has been modified other than at the manufacturer's instruction. The warranty does not cover components which have a limited life, and which are expected to be periodically replaced for optimal performance. We do not warrant that the unit shall operate in any other way than as described in this manual.

Audient Ltd
Aspect House
Herriard
Hampshire
RG25 2PN
United Kingdom

Tel: +44 1256 381944

www.audient.com

A	Amperes
A.C.	Alternating Current
ADAT	Alesis Digital Audio Tape
ADC	Analogue to Digital Converter
AES	Audio Engineering Society - AES Digital Audio Format
ASP	Analogue Signal Processing
DAW	Digital Audio Workstation
DAC	Digital to Analogue Converter
dB	Decibel
dBa	Decibel - measured using an A-Weighting Filter
dBu	Decibel referenced to 0.775Vrms = 0 dBu
dBFS	Decibel Full Scale
DB25	25-Pin DSUB Connector - Analogue Tascam Format
D.C.	Direct Current
D.I	Direct Injection (Instrument Input)
DoC	Declaration of Conformity
EIN	Equivalent Input Noise
FAQ	Frequently Asked Questions
HPF	High Pass Filter
HMX	Harmonic Saturation
HV	High Voltage
Hz	Hertz, cycles per second - measurement unit of frequency
i/o	Input / Output
IRON	Reference to Vintage Audio Transformer Core Material
JFET	Junction Field Effect Transistor
LED	Light Emitting Diode
MOSFET	Metal Oxide Semiconductor Field Effect Transistor
Ohm	Ω , Unit of Resistance
RoHS	Restriction of Hazardous Substances
S/PDIF	Sony Philips Digital Interconnect Format
SMUX	Sample Multiplexing
THD+N	Total Harmonic Distortion + Noise
TRS	Tip Ring Sleeve [1/4" Jack Balanced]
TS	Tip Sleeve [1/4" Jack Unbalanced]
USB	Universal Serial Bus
V	Volts
XLR	Extra Live Return, Extremely Low Resistance, Canon X Series, Latching, Resilient Rubber Compound... or make up your own!
Z	Ohms, Ω , Input Impedance - can be varied by adjusting Z switch