

# USB3.0 HD PTZ Camera

---

User Manual V1.2

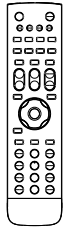

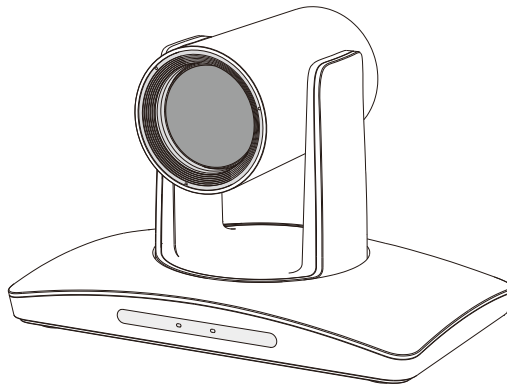

---

## Safety Notes

- Before installing the device, please read this manual carefully and follow instructions indicated to ensure proper operation. Please keep this manual for future reference.
- Please powering on the device, please check the input power voltage carefully, the camera accepts DC12V, otherwise, it may cause damage to the camera.
- Please put power, video and control cables at safe place in order not to cause malfunction to the device.
- Please put the device into use at required working temperature and humidity, working condition of the device is 0°C~+40°C , humidity at < 90 % . Please avoid to have unrelated objects get into the device like corrosive liquid that may cause damage / danger.
- Please avoid shock, vibration, soaking may cause to the device when transporting and installing, otherwise, it may cause damage to the camera.
- Please only refer to authorized personnel to repair the device, do not disassemble the camera by yourself.
- Only use shielded control and video cables, and the cables should be connected separately in order to ensure proper use. Do not aim the camera lens at sunlight or strong lights that may cause damage to the imaging system of the device.
- Please use soft cloth to clean the device, do not use strong or abrasive detergent to clean that will damage the device's housing / lens.



---

# Contents

<b>PRODUCT OVERVIEW</b> .....	<b>1</b>
FEATURES .....	1
PACKING LIST.....	1
MAIN PARTS AND CONTROL INTERFACES .....	2
DIP SWITCH SETTING .....	3
REMOTE CONTROL.....	4
<b>CABLE CONNECTING</b> .....	<b>6</b>
<b>INSTALLATION</b> .....	<b>7</b>
DESKTOP MOUNT INSTALLATION .....	7
WALL MOUNT INSTALLATION .....	7
CEILING MOUNT INSTALLATION .....	8
POLE MOUNT INSTALLATION .....	9
<b>AMCAP CAPTURE SOFTWARE</b> .....	<b>10</b>
<b>DRIVER INSTALLATION OF USB VIRTUAL SERIAL PORT</b> .....	<b>10</b>
<b>MENU SETTINGS</b> .....	<b>11</b>
MENU CONFIGURATION.....	11
MENU EXPLANATION.....	15
VIDEO .....	16
EXPOSURE .....	16
WHITE BALANCE.....	17
PAN/TILT/ZOOM.....	17
SYSTEM.....	18
STATUS .....	19
RESTORE DEFAULTS.....	19
LIST OF SPECIAL PRESET COMMANDS.....	19
<b>ANNEX 1 TECHNICAL SPECIFICATIONS</b> .....	<b>20</b>
<b>ANNEX 2 SIZE AND DIMENSION</b> .....	<b>22</b>

**ANNEX 3 SW1 DEFINITION ----- 23**  
**TROUBLESHOOTING ----- 25**

---

# PRODUCT OVERVIEW

---

## Features

- 2.14MP, 1/2.8" CMOS sensor;
- USB3.0 high speed raw data output, supports USB2.0 output;
- Standard UVC1.1 protocol;
- Support full HD output at maximum 1080P60 format;
- 12x optical zoom, 12x digital zoom/10x optical zoom, 12x digital zoom;
- 72.5 degree wide view angle;
- Provide one channel USB3.0 and one channel DVI-D HD video output;
- Has RS232 in, RS232 out and RS485 control interfaces;
- Special PTZ driving system to ensure precise positioning;
- Built-in OSD menu;
- With an IR remote control;
- Has image flip function, suitable for stand and suspended installation;
- Supports VISCA and PELCOD communication protocols, daisy chain is possible.

---

## Packing List

When you open the package, please make sure below items are included. If any items is missing, please contact your supplier.

### PTZ Camera x 1

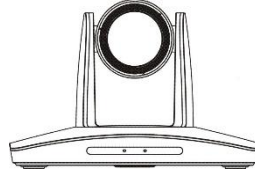

### Power Adapter x 1

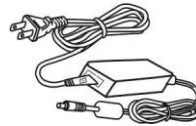

### Remote Control x 1

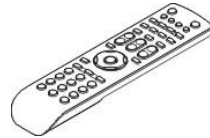

### RS-232 Control Cable x 1



### USB Cable x 1



### manual ( 1 )

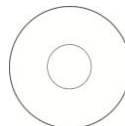

# Main Parts and Control Interfaces

## PTZ Camera

### Front Part

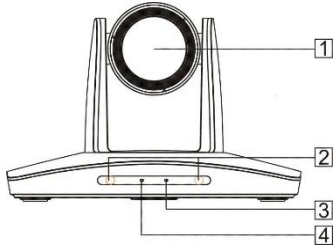

- 1 Camera Module
- 2 Remote Control Sensor
- 3 Power Indicator
- 4 Communication Indicator

### Rear Part

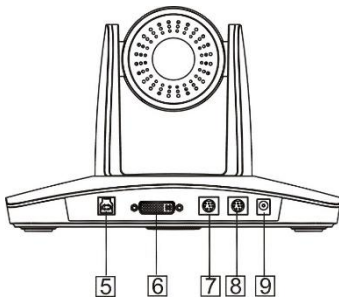

- 5 USB3.0
- 6 DVI
- 7 RS-232IN/IR
- 8 RS-232OUT/RS-485

9 Power Input ( DC12V )

### Bottom Part

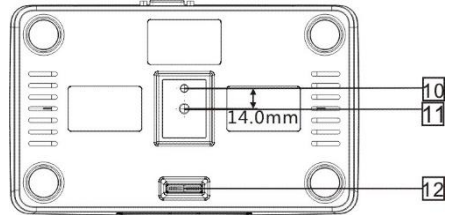

- 10 Locating Hole  
Used to define installation direction of the camera.
- 11 Installation Hole  
1/4" inch screw, used to fix the camera.
- 12 DIP Switch  
Used to set address, protocol, baud rate and other parameters.



# DIP Switch Setting

Before operating the camera, please set camera's address, baud rate protocol and etc. through its DIP switch located at the bottom part of the camera. There are two switches named SW1 and SW2.

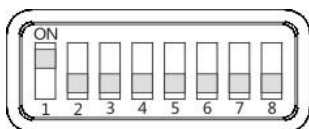

**Note**



The SW1 and SW2 switches look the same, their settings are different. SW1 is used to set camera's address and mounting types, while SW2 is used to set camera's control protocol and baud rate.

Default Settings	
Camera Address	1
Baud Rate	9600bps
Protocol	VISCA
Video Output Format	1080P25
Mounting Type	Stand

## SW1 Settings

Use DIP1 to DIP6 to set 64 address accordingly. DIP7 is reserved. DIP8 is used to set camera's mounting type. Please refer to Annex 3 for detailed SW1 definitions.

## SW2 Settings

Use SW2 to set camera's protocol, baud rate. Use DIP1 and DIP2 to set camera's protocol, use DIP 3 and DIP4 to set camera's baud rate. DIP5~DIP8 switches are reserved.

SW2			
DIP No.	1	2	
Protocol	OFF	OFF	VISCA
	ON	OFF	PELCO- D
	OFF	ON	PELCO- P
	ON	ON	-
DIP No.	3	4	
Baud Rate	OFF	OFF	2400
	ON	OFF	4800
	OFF	ON	9600
	ON	ON	38400



**Note**

It requires a reboot of the PTZ for the switch setting to take effect.

# Remote Control

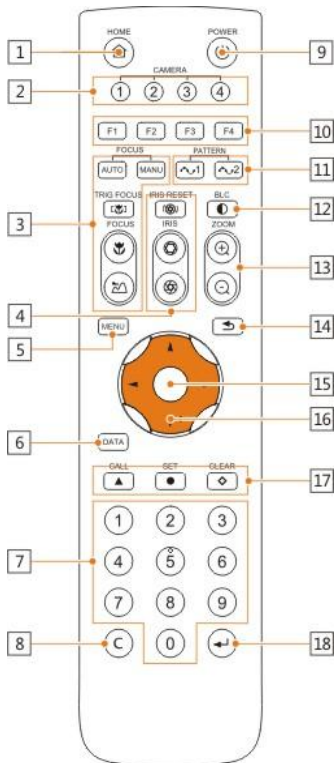

## 1 HOME button

Press **HOME** button, camera moves to initial position where both pan and tilt angle is zero.

## 2 Camera Selection Button

Used to switch among 4 cameras, press 1-4 number buttons to control cameras with 1-4 address respectively. For example, press

button 1 to control the camera with address 1.

## 3 Focus



Press "AUTO" button to switch to Auto Focus mode, press "MANU" button to switch to Manual Focus mode.

"" button to Focus Near

"" button to Focus Far

"" button to Auto Focus once every time it is pressed, then switch back to Manual Focus mode.

## 4 Iris

Press "" button to reset iris value to default. "" button to Iris Open

"" button to Iris Close.

## 5 Menu

Press **MENU** button to enter / exit menu.

## 6 Data

Press **DATA** button to turn on / off display of pan tilt angel, zoom times and title info

## 7 Number Keys

Used to input numbers, for example, preset number.

## 8 Cancel

Used to delete number inputted.

## 9 Power

After the camera has been connected to power source, in none-menu status, press this button to turn on / off the camera.

### 10 Reserved buttons ( F1, F2, F3, F4 )

These buttons are reserved for future use.

### 11 Pattern

Used to activate Pattern Scan1 and Pattern Scan2.

### 12 BLC

Used to open / close back light compensation.

### 13 Zoom

Used to adjust zooming times.

“” button to zoom in

“” button to zoom out.

### 14 Back

Press “” button to go back to previous menu.





### 15 OK

In None-menu status: press this button to switch among pan / tilt control speeds.

In Menu status: get into relative menu option after it has been selected.

### 16 Direction / Menu Operation

In None-menu status: press these four buttons to pan left/right and tilt up/down.

In Menu status:  or  button to select among menu options,  or  to change option / value.

### 17 Preset Setting

“” button to call a preset.

Input number key(s), and then press this button to call a preset.

“” button to set a preset.

Move the camera to a specific position, adjust focus value and etc., and then press this button to set a preset.

“” button to clear a preset.

Input number key(s), and then press this button to clear a preset.

### 18 Enter

After inputting numbers, press this button to confirm.

---

## CABLE CONNECTING

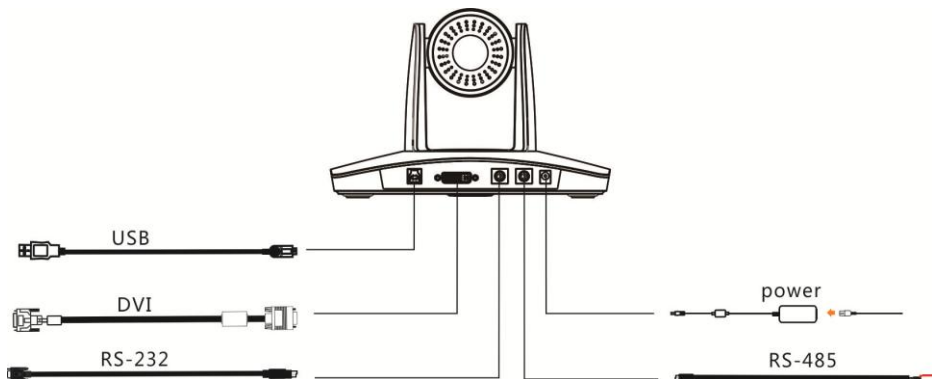

### Note

If preset 0 has been saved, after powered on, camera moves to preset 0 automatically; if preset 0 has not been saved, after powered on, camera moves to Home position, where both pan and tilt angle is zero and zooming time is 1x.

---

# INSTALLATION

The camera has 4 installation types:  
desktop, wall (optional), ceiling (optional)  
and pole (optional) mount installations.

## Note

Before installing, make sure there is enough space to install the camera and its parts.



Make sure the installed place is strong and safe enough to hold the camera and relative parts, it is suggested that the installed place can withstand 4 times the weight of the camera and its relative parts

---

## Desktop Mount Installation

1. Put the camera on a flat surface. In case the camera has to be placed on an inclined surface, make sure the cline angle is less than 15 degrees to ensure proper pan /tilt operation.

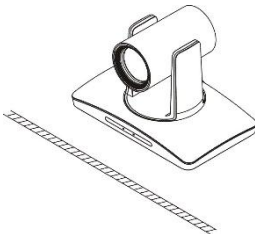

## Note



- Take effective measures to avoid camera from dropping.
- Do not grab the camera head

when carrying.

- Do not rotate the camera head with hand. It may cause malfunction to the camera.

---

## Wall Mount Installation

(Bracket not supplied with camera)

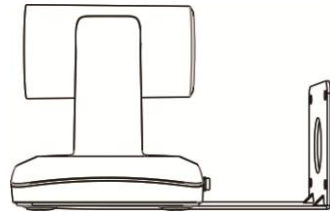

1. According to diameter and position of the 4 installation holes (As shown below) on the bracket, drill 4 holes on the wall and fix the bracket onto the wall by using 4 screws which should be prepared by yourself.

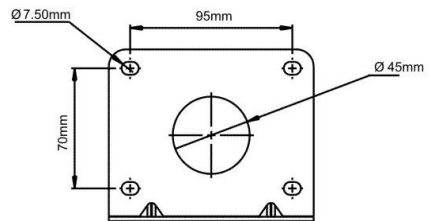

1. Before fixing the camera, set the DIP switches of the camera correctly.
2. Use inch screws to fix the camera on the bracket, fix the limit screw
3. According to actual requirement, and make sure the camera is tightly fixed

onto the bracket before your hands leave the camera.

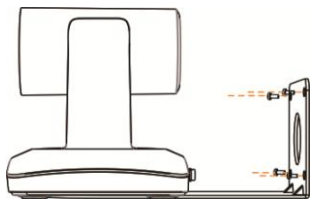

2. Fix the plate onto the ceiling by using 4 screws which should be prepared by yourself.

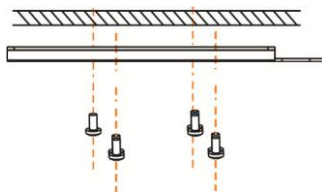

## Ceiling Mount Installation

(Bracket not supplied with camera)

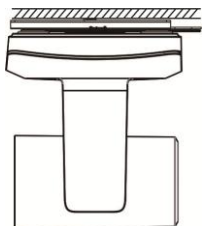

1. According to diameter and position of the 4 installation holes (As shown below) on the bottom plate, drill 4 holes on the ceiling.

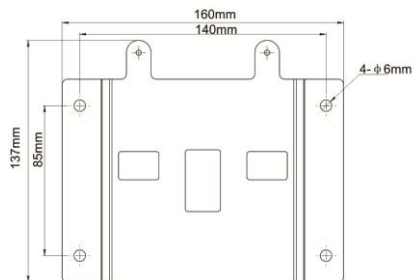

3. Before fixing the camera, set the DIP switches of the camera correctly.

4. Use inch screws to fix the bottom plate on the ceiling, fix the limit screw



5. Slide the PTZ camera via the slot of the plate and fix the camera to the plate.

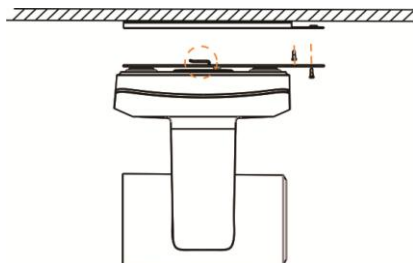

# Pole Mount Installation

(Bracket not supplied with camera)

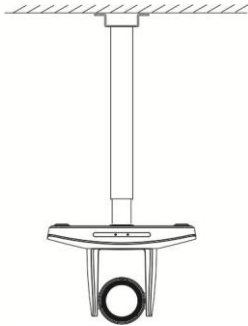

1. According to diameter and position of the 4 installation holes (As shown below) on the bracket, drill 4 holes on the ceiling.

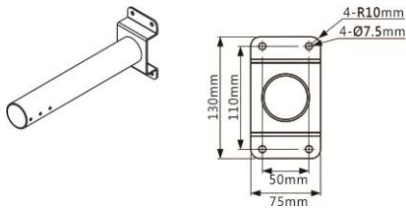

2. Fix the bracket onto the ceiling by using 4 screws which should be prepared by yourself.

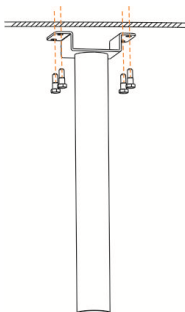

3. Adjust the length of the pole mount.



4. Before fixing the camera, set the DIP switches of the camera correctly. Use inch screws to fix the camera on the bracke

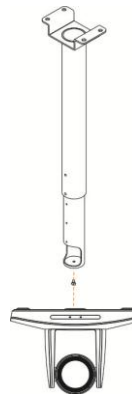

---

# AMCAP Capture

## Software

Open AMCAP V3.0.9.exe capture software, choose “UVC”, from “Options”, tick “Preview” to view camera image.

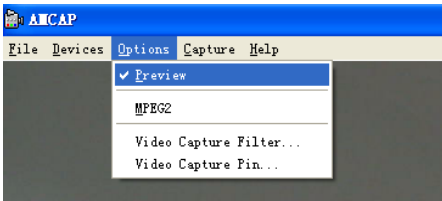
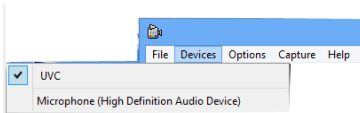

If frame rate is not enough, go to “Capture” / “Set Frame Rate” / “Use Frame Rate” and disable it.

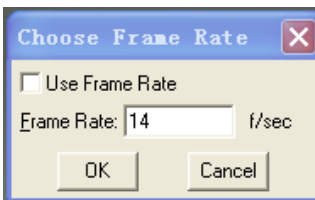
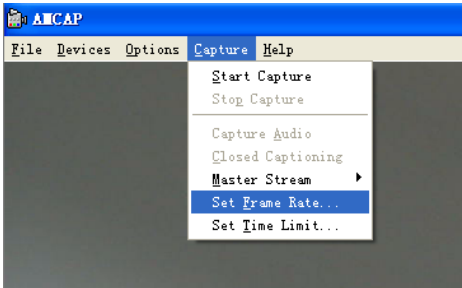

To change frame rate or resolution, go to “Capture” / “Set Frame Rate” / “Use Frame Rate” and change value accordingly.

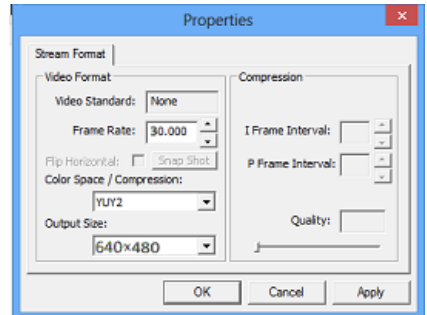
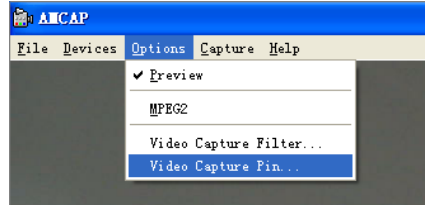

---

## Driver Installation of USB Virtual Serial Port

The camera supports one USB virtual serial port at the same time, with which the camera can be controlled. Driver installation is required. Before installation, the USB connection between PC and the camera shall be removed



---

# MENU SETTINGS

---

## Menu Configuration

<VIDEO> \_\_\_\_\_ SHARPNESS \_\_\_\_\_ 0, 1, 2, 3, 4, 5, 6, 7, 8, 9, 10, 11, 12, 13, 14, 15  
\_\_\_\_\_ CONTRAST \_\_\_\_\_ 0, 1, 2, 3, 4, 5, 6, 7, 8, 9, 10, 11, 12, 13, 14  
\_\_\_\_\_ SATURATION \_\_\_\_\_ 0, 1, 2, 3, 4, 5, 6, 7, 8, 9, 10, 11, 12, 13, 14  
\_\_\_\_\_ HUE \_\_\_\_\_ 0, 1, 2, 3, 4, 5, 6, 7, 8, 9, 10, 11, 12, 13, 14  
\_\_\_\_\_ 2DNR LEVEL \_\_\_\_\_ OFF , ON  
\_\_\_\_\_ 3DNR LEVEL \_\_\_\_\_ AUTO , 1 , 2 , 3 , 4 , OFF  
\_\_\_\_\_ WIDE DYNAMIC \_\_\_\_\_ ON , OFF

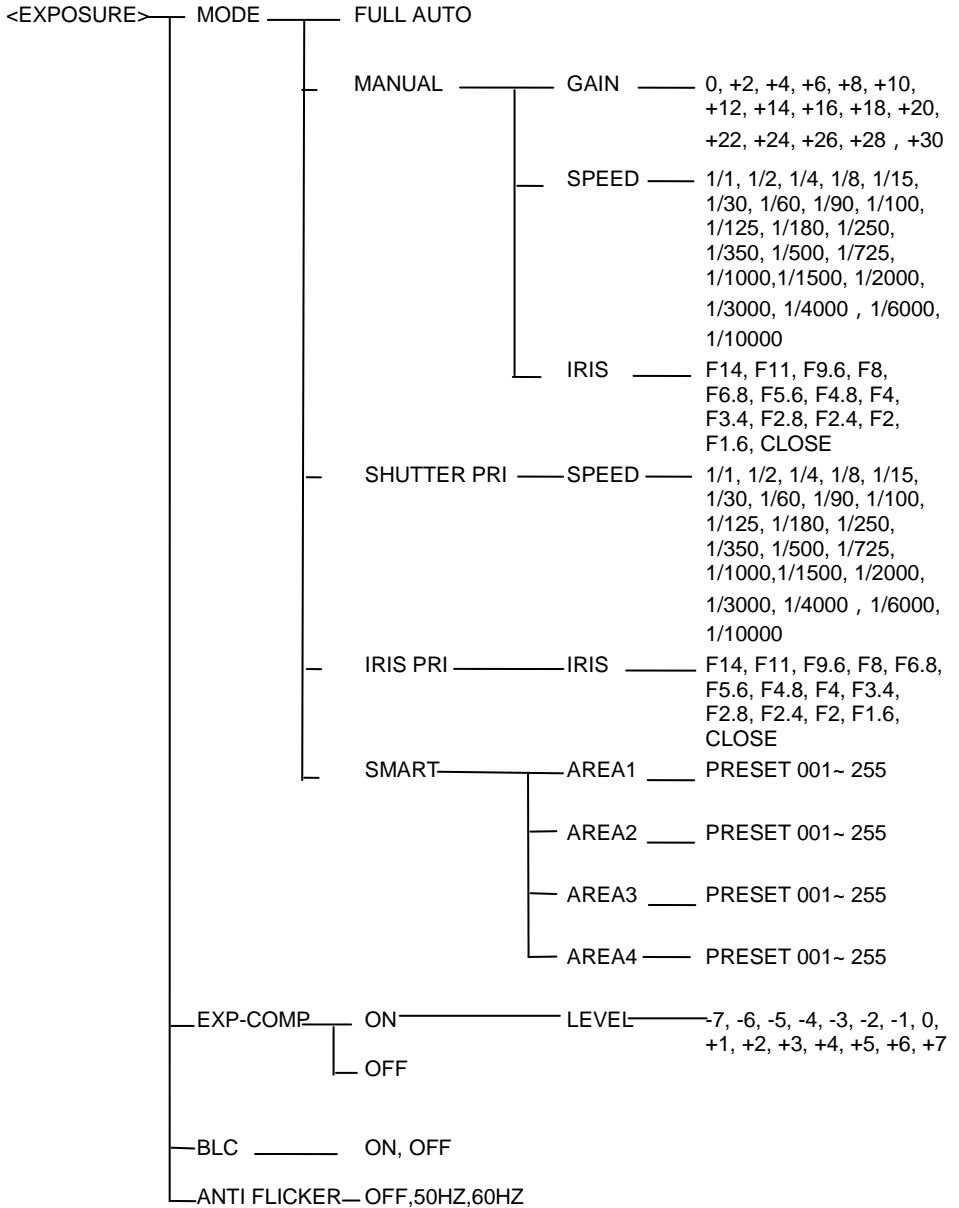

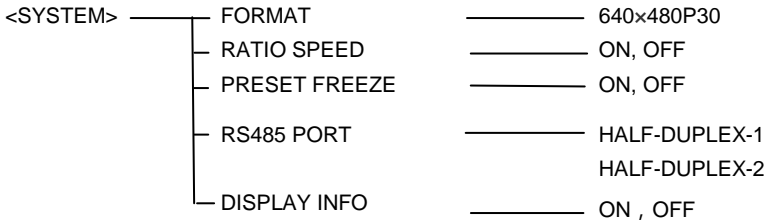
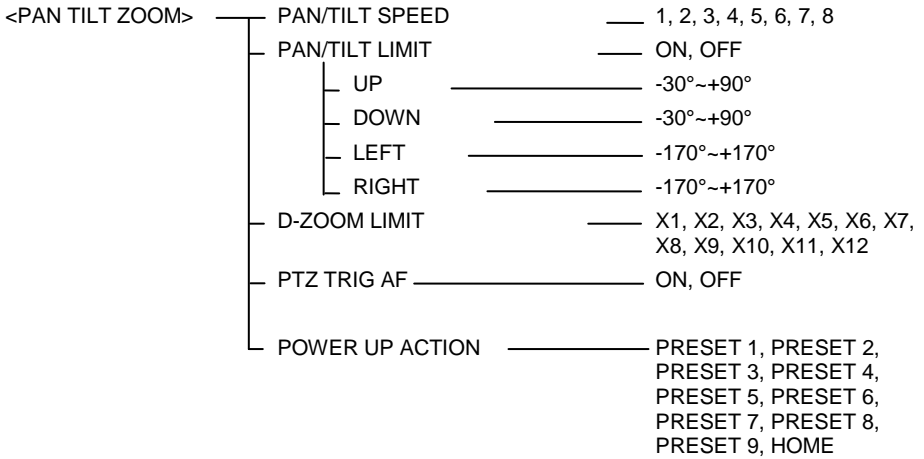
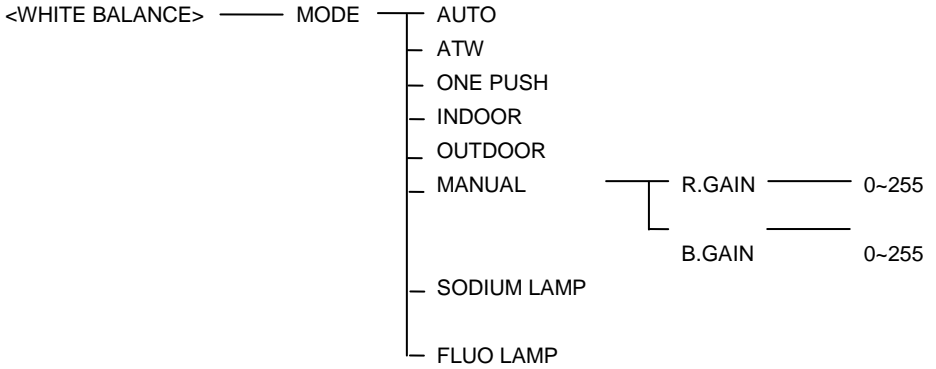

<STATUS>	ADDRESS	1
	PROTOCOL	VISCA
	BAUD RATE	9600
	FORMAT	640x480P30
	MOUNT	STAND
	IMAGE VER	V1606
	USB FW VER	V1.0.0
	FIRMWARE	V1.0.0

<RESTORE DEFAULTS>

# Menu Explanation

## Main Menu

Press **MENU** button to enter / exit menu.

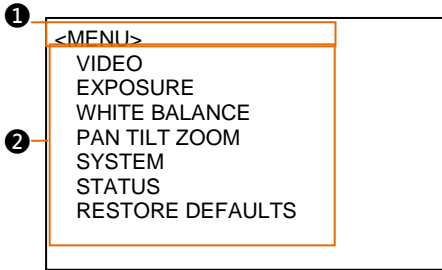

### 1 Menu Hint

It displays currently selected menu option.

### 2 Menu Options

It displays options under current menu hint.

Press **▲** or **▼** button to select among menu options, once font of options turned from white color to yellow color, it indicates the menu has been elected, press OK button to get into this menu.

## Submenus

From main menu, navigate to select <EXPOSURE> menu, press **OK** to enter.

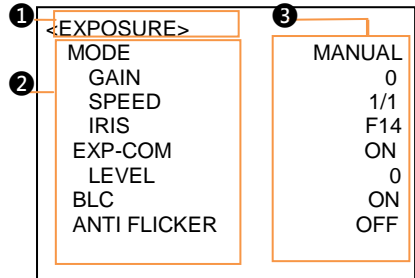

**1 2** Refer to Main Menu explanations.

### 3 Manual Exposure

Press **◀** or **▶** button to change value.

---

## Video

VIDEO is used to change video value.

<VIDEO>	
SHARPNESS	8
CONTRAST	2
SATURATION	5
HUE	0
2DNR LEVEL2D	OFF
3DNR LEVEL 3D	OFF
WIDE DYNAMIC	OFF

### Available Options:

**SHARPNESS:** 0, 1, 2, 3, 4, 5, 6, 7, 8, 9, 10, 11, 12, 13, 14, 15.

**CONTRAST:**0, 1, 2, 3, 4, 5, 6, 7, 8, 9, 10, 11, 12, 13, 14.

**SATURATION :**0, 1, 2, 3, 4, 5, 6, 7, 8, 9, 10, 11, 12, 13, 14.

**HUE :** 0, 1, 2, 3, 4, 5, 6, 7, 8, 9, 10, 11, 12, 13, 14.

### 2DNR LEVEL: OFF, ON

If camera displays color image, it is suggested to turn off the 2DNR level, otherwise, the video trails will be generated. The higher the level is, the better is the noise reduction performance, but more video trails will be generated.

**3DNR LEVEL:** OFF, AUTO, 1 , 2 , 3 , 4.

**WIDE DYNAMIC:** ON, OFF.

---

## Exposure

EXPOSURE menu is used to adjust exposure value.

<EXPOSURE>	
MODE	MANUAL
GAIN	0
SPEED	1/1
IRIS	F14
EXP-COMP	ON
LEVEL	0
BLC	ON
ANTI FLICKER	OFF

### Available Options:

#### MODE

**FULL AUTO:** Gain, Shutter Speed and Iris value are adjusted automatically according to working environment.

**MANUAL:** manually adjust Gain, Shutter Speed and Iris

**GAIN:** 0, +2, +4, +6, +8, +10, +12, +14, +16, +18, +20, +22, +24, +26, +28 , +30

**SPEED:** 1/1, 1/2, 1/4, 1/8, 1/15, 1/30, 1/60, 1/90, 1/100, 1/125, 1/180, 1/250, 1/350, 1/500, 1/725, 1/1000,1/1500, 1/2000, 1/3000, 1/4000 , 1/6000, 1/10000.

**IRIS:** F14, F11, F9.6, F8, F6.8, F5.6, F4.8, F4, F3.4, F2.8, F2.4, F2, F1.6, CLOSE.

**SHUTTER PRI:** Gain and Iris value are adjusted automatically according to working environment; shutter speed value is adjustable manually.

**SPEED:** 1/1, 1/2, 1/4, 1/8, 1/15, 1/30,  
 1/60, 1/90, 1/100, 1/125, 1/180, 1/250,  
 1/350, 1/500, 1/725, 1/1000, 1/1500,  
 1/2000, 1/3000, 1/4000 , 1/6000, 1/10000.

**IRIS PRI:** Gain and shutter speed value are adjusted automatically according to working environment; Iris value is adjustable manually.

**IRIS:** F14, F11, F9.6, F8, F6.8, F5.6, F4.8, F4, F3.4, F2.8, F2.4, F2, F1.6, CLOSE.

**EXP-COMP:** once EXP-COMP is set as On, below level options become available -7, -6, -5, -4, -3, -2, -1, 0, +1, +2, +3, +4, +5, +6, +7,+7 is the maximum compensation value for bright, -7 is the maximum compensation value for dark.

**BLC:** ON, OFF

Backlight compensation (BLC) is video gain done automatically to correct the exposure of subjects that are in front of a bright light source.

**ANTI-FLICKER :** OFF, 50HZ, 60HZ

This option is used to address the image flicker issue when camera is used in different lighting environment.

---

## White Balance

WHITE BALANCE menu is used to select from white balance modes.

<WHITE BALANCE>	
MODE	MANUAL
R.GAIN	1
B.GAIN	128

### Available Options:

**MODE:** AUTO, ATW(auto tracking), ONE PUSH, INDOOR, OUTDOOR), MANUAL , SODIUM LAMP, FLUO LAMP.

**“ONE PUSH”:** When in “ONE PUSH TRIGGER” mode, aim the camera at a pure white object (say a white paper), then press OK button.

**“MANUAL”:** R.GAIN and B. GAIN value can be chosen from 0~255.

---

## Pan/Tilt/Zoom

PAN/TILT/ZOOM is used to change pan/tilt/zoom value.

<PAN TILT ZOOM>	
PAN/TILT SPEED	8
PAN/TILT LIMIT	ON
UP	+90
DOWN	30
LEFT	+170
RIGHT	-170
D-ZOOM LIMIT	X4
PTZ TRIG AF	OFF
POWER UP ACTION	HOME

### Available Options:

**PAN/TILT SPEED:** 1, 2, 3, 4, 5, 6, 7, 8 the bigger the number is, the faster the speed is.

The speed is the fastest when in 1x zoom compared to other zooming times.

**PAN/TILT LIMIT:** ON/OFF, once it is set as ON, below limit value can be set

- UP:** -30°~+90°, adjustable every 1°;
- DOWN:** -30°~+90°, adjustable every 1°;
- LEFT:** -170°~+170°, adjustable every 1°;
- LIGHT:** -170°~+170°, adjustable every 1°.

**D-ZOOM LIMIT:** X1, X2, X3, X4, X5, X6,

**PTZ TRIG AF:** Turn ON / OFF the auto focus when the camera pans / tilts / zooms.

**POWER UP ACTION:** PRESET 1, PRESET 2, PRESET 3, PRESET 4, PRESET 5, PRESET 6, PRESET 7, PRESET 8, PRESET 9, HOME.

---

## System

<SYSTEM>	
FORMAT	640 x 480P60
RATIO SPEED	ON
PRESET FREEZE	OFF
RS485PORT	HALF-DUPLEX-1
DISPLAY INFO	OFF

### FORMAT:

1920x1080P/60/50/30/25/20/15/10/5  
1280x720P/60/50/30/25/20/15/10/5  
1024x768P/60/50/30/25/20/15/10/5  
800x600P/60/50/30/25/20/15/10/5

640x480P/60/50/30/25/20/15/10/5.

### Note

- The videos from USB and DVI-D are simultaneously output only at 1080P60/50/30/25, 720P60/50/30/25.
- When the videos from USB and DVI-D are simultaneously output, Video from USB may not be output when the DVI-D video formats are changed via menu or preset.
- The format change of USB video will change the format of DVI-D video. When the format of USB video is changed to one that is not supported by DVI-D video, The DVI-D video will not be output.



**RATIO SPEED :** ON, OFF

When RATIO SPEED is set as ON, pan speed changes automatically based on zooming times, that is, the more zooming times, the

**PRESET FREEZE :** ON, OFF

When it is on, during a regular preset call, the video will be frozen at point A till Point B. At Point B, the video will be displayed normally.

**RS-485(RS-485 modes)**

**HALF-DUPLEX-1:** in VISCA protocol, camera will not return confirmation, completion or error messages after commands have been executed.

**HALF-DUPLEX-2:** in VISCA protocol, camera will return confirmation,



completion or error messages after commands have been executed.

**DISPLAY INFO:** Turn ON / OFF display of pan / tilt angle and prompt message.

---

## Status

<STATUS>	
ADDRESS	1
PROTOCOL	VISCA
BAUD RATE	9600
FORMAT	640 x 480P30
MOUNT	STAND
IMAGE VER	V1606
USB VER	V1.0.0
FIRMWARE	V1.0.0

It displays current camera's address, protocol, baud rate, video format, mount mode and software version number.

---

## Restore Defaults

< RESTORE DEFAULTS>		
PRESS	OK	CONFIRM
PRESS	BACK	CANCEL

**RESTORE DEFAULTS :** This option is used to reset all menus to default value.

Press OK to confirm or press ↵ to cancel and return to previous menu.

---

## List of Special Preset

### Commands

93	Cruise, camera switches among saved 0~29 presets repeatedly and sequentially in fixed interval.
95	Get into menu
96	Delete all presets
99	Reboot the camera
100	1920X1080P50
101	1920X1080P25
103	1280X720P50
104	1280X720P25
105	1920X1080P60
106	1920X1080P30
108	1280X720P60
109	1280X720P30

# ANNEX 1 TECHNICAL SPECIFICATIONS

Image Sensor	1/2.8" CMOS, 2.14 megapixel	
Video Format	USB3.0 : 1920x1080P/60/50/30/25/20/15/10/5 1280x720P/60/50/30/25/20/15/10/5 1024x768P/60/50/30/25/20/15/10/5 800x600P/60/50/30/25/20/15/10/5 640x480P/60/50/30/25/20/15/10/5  USB2.0 : 1920x1080P5; 1280x720P10/5; 800x600P30/25/20/15/10/5 640x480P30/25/20/15/10/5  DVI-D: 1920x1080P/60/50/30/25 1280x720P/60/50/30/25	
Focal Lens	f=3.9mm-46.8mm	f=4.7mm-47.0mm
Iris	F1.6-F2.8	F1.6-F3.0
Optical Zoom	12x	10x
Digital Zoom	12x	
Field of View	72.5°-6.3°	60.9°-6.43°
Focus System	Auto, Manual, PTZ trigger, One push trigger	
Min.Illumination	0.5 lux (color) , 0.1Lux (B/W)	
Shutter Speed	1/1 to 1/10,000s	
Gain	Auto /Manual	
White Balance	Auto, indoor, outdoor, one push, manual, auto tracking	
Wide Dynamic	Yes	
Exposure Control	Auto, Manual, Shutter Priority, Iris Priority	
S/N	≥50dB	
Pan Angle	-170°~+170°	
Tilt Angle	-30°~+90°	
Pan Speed	0.1°~120°/S	
Tilt Speed	0.1°~80°/S	
Preset Number	256	

OSD	Yes
Image Flip	Yes
HD Video Output	USB3.0 , DVI-D
Control Interface	USB3.0 , RS-232IN , RS-232OUT , RS-485
UVC Protocol	UVC 1.1
UVC PTZ Control	Yes
Protocol	VISCA (supports daisy chain) / PELCO-P / PELCO-D
Address	0~63
Power	DC12V
Power Consumption	< 20W
Operating Temperature	0°C~+40°C
Storage Temperature	-20°C~+60°C
Dimensions (WxDxH )	243mm×145mm×163mm
Weight	1.2KG
Body Color	Grey

# ANNEX 2 SIZE AND DIMENSION

Front

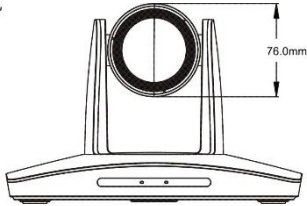

Rear

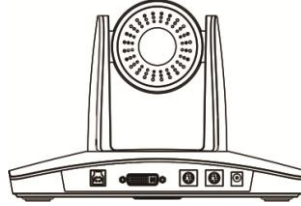

Top

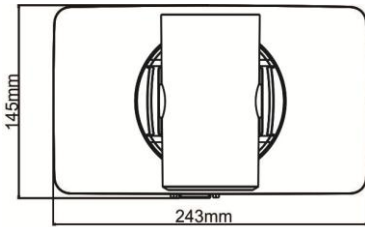

Side

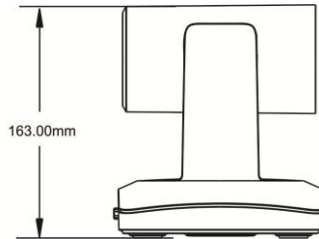

Bottom

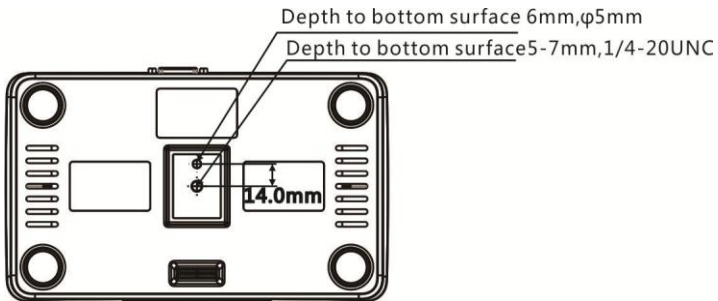

# ANNEX 3 SW1 DEFINITION

SW1 DIP Address	1	2	3	4	5	6
0	OFF	OFF	OFF	OFF	OFF	OFF
1	ON	OFF	OFF	OFF	OFF	OFF
2	OFF	ON	OFF	OFF	OFF	OFF
3	ON	ON	OFF	OFF	OFF	OFF
4	OFF	OFF	ON	OFF	OFF	OFF
5	ON	OFF	ON	OFF	OFF	OFF
6	OFF	ON	ON	OFF	OFF	OFF
7	ON	ON	ON	OFF	OFF	OFF
8	OFF	OFF	OFF	ON	OFF	OFF
9	ON	OFF	OFF	ON	OFF	OFF
10	OFF	ON	OFF	ON	OFF	OFF
11	ON	ON	OFF	ON	OFF	OFF
12	OFF	OFF	ON	ON	OFF	OFF
13	ON	OFF	ON	ON	OFF	OFF
14	OFF	ON	ON	ON	OFF	OFF
15	ON	ON	ON	ON	OFF	OFF
16	OFF	OFF	OFF	OFF	ON	OFF
17	ON	OFF	OFF	OFF	ON	OFF
18	OFF	ON	OFF	OFF	ON	OFF
19	ON	ON	OFF	OFF	ON	OFF
20	OFF	OFF	ON	OFF	ON	OFF
21	ON	OFF	ON	OFF	ON	OFF
22	OFF	ON	ON	OFF	ON	OFF
23	ON	ON	ON	OFF	ON	OFF
24	OFF	OFF	OFF	ON	ON	OFF
25	ON	OFF	OFF	ON	ON	OFF
26	OFF	ON	OFF	ON	ON	OFF
27	ON	ON	OFF	ON	ON	OFF
28	OFF	OFF	ON	ON	ON	OFF
29	ON	OFF	ON	ON	ON	OFF
30	OFF	ON	ON	ON	ON	OFF
31	ON	ON	ON	ON	ON	OFF
32	OFF	OFF	OFF	OFF	OFF	ON
33	ON	OFF	OFF	OFF	OFF	ON
34	OFF	ON	OFF	OFF	OFF	ON
35	ON	ON	OFF	OFF	OFF	ON
36	OFF	OFF	ON	OFF	OFF	ON
37	ON	OFF	ON	OFF	OFF	ON
38	OFF	ON	ON	OFF	OFF	ON
39	ON	ON	ON	OFF	OFF	ON

40	OFF	OFF	OFF	ON	OFF	ON
41	ON	OFF	OFF	ON	OFF	ON
42	OFF	ON	OFF	ON	OFF	ON
43	ON	ON	OFF	ON	OFF	ON
44	OFF	OFF	ON	ON	OFF	ON
45	ON	OFF	ON	ON	OFF	ON
46	OFF	ON	ON	ON	OFF	ON
47	ON	ON	ON	ON	OFF	ON
48	OFF	OFF	OFF	OFF	ON	ON
49	ON	OFF	OFF	OFF	ON	ON
50	OFF	ON	OFF	OFF	ON	ON
51	ON	ON	OFF	OFF	ON	ON
52	OFF	OFF	ON	OFF	ON	ON
53	ON	OFF	ON	OFF	ON	ON
54	OFF	ON	ON	OFF	ON	ON
55	ON	ON	ON	OFF	ON	ON
56	OFF	OFF	OFF	ON	ON	ON
57	ON	OFF	OFF	ON	ON	ON
58	OFF	ON	OFF	ON	ON	ON
59	ON	ON	OFF	ON	ON	ON
60	OFF	OFF	ON	ON	ON	ON
61	ON	OFF	ON	ON	ON	ON
62	OFF	ON	ON	ON	ON	ON
63	ON	ON	ON	ON	ON	ON

DIP No.	7	
reserve	reserve	reserve
DIP No.	8	
Mounting Type	ON	Ceiling
	OFF	Desktop

# TROUBLESHOOTING

Problem	Possible Cause	Solution
No action or image after powered on	Power supply failure	Check power supply
	Power adapter damaged	Replace power adapter
	Power cable connection got loosen	Check & reconnect
No self-testing after powered on, or with motor noise	Not enough power supply	Check & reconnect power cable connection
	Mechanical failure	Repair
Not controllable from remote controller	Low battery of remote controller	Change battery for remote controller
	Exceed remote control distance	Control within distance of 8M
After power on, self-test successfully, but not controllable	Wrong address / protocol / baud rate	Check & set again
	Wrong connection or open circuit of RS-485 or RS-232 cable	Check & reconnect
Video loss when pans / tilts / zooms	Not enough power supply	Check & reconnect power cable
	Video cable not properly connected	Replace with a good video cable
Video captured after connected to digital video interface of a capture device is not good as the video captured after connected directly analog video interface of the capture device	Different video capture devices have different video capturing performance, image quality maybe worse after it has been converted from analog to digital	Consult video capture device supplier for more information











