

T

T10 Manual 1.1 en

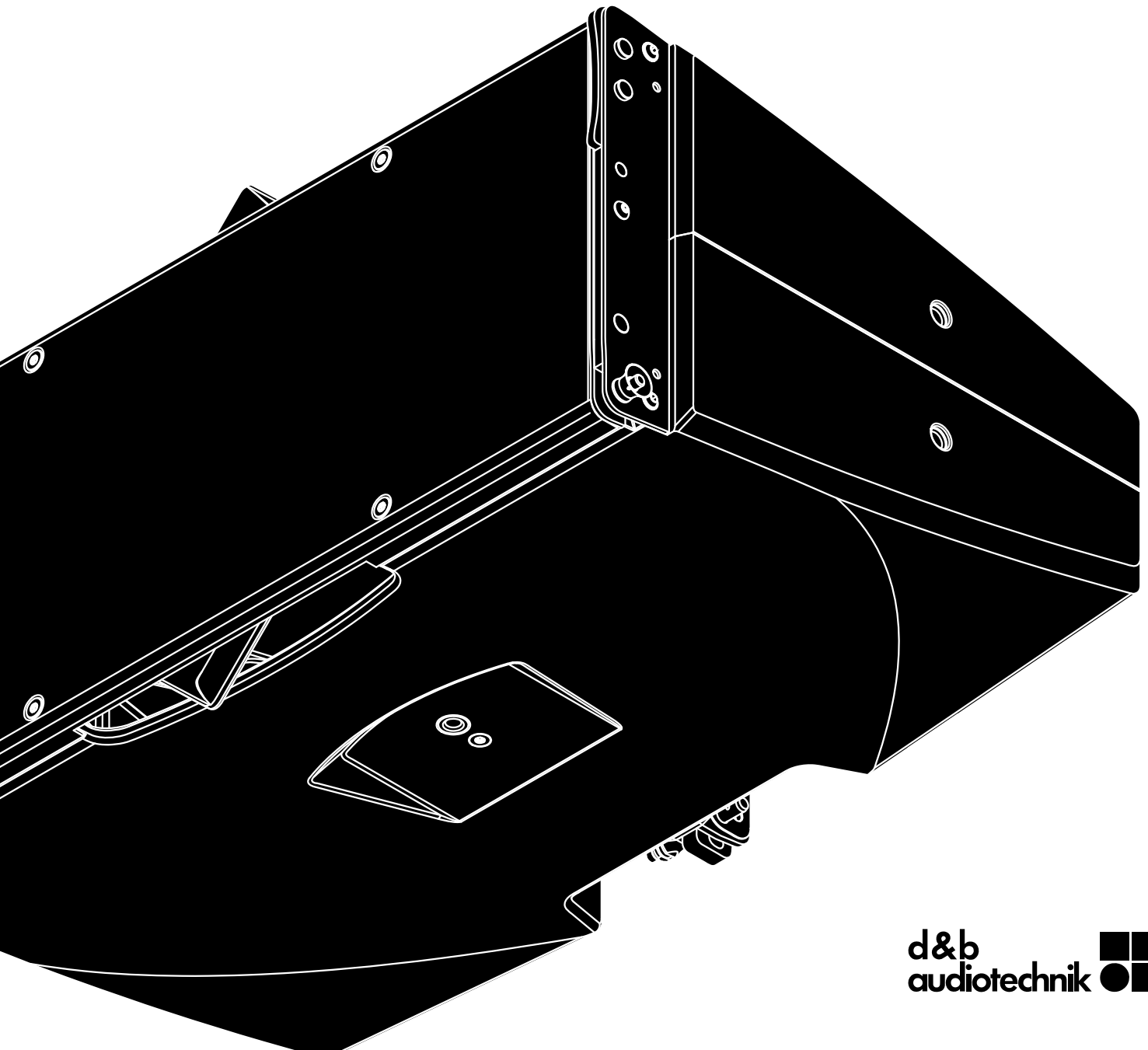

General information

T10 Manual

Version: 1.1 en, 06/2023, D2600.EN .01

Copyright © 2023 by d&b audiotechnik GmbH & Co. KG; all rights reserved.

Keep this document with the product or in a safe place so that it is available for future reference.

We recommend you to regularly check the d&b website for the latest version of this document.

When reselling this product, hand over this document to the new owner.

If you supply d&b products, please draw the attention of your customers to this document. Enclose the relevant documents with the systems. If you require additional documents for this purpose, you can order them from d&b.

d&b audiotechnik GmbH & Co. KG
Eugen-Adolff-Str. 134, D-71522 Backnang, Germany
T +49-7191-9669-0, F +49-7191-95 00 00

1	Safety precautions	4
2	T10 loudspeaker	5
2.1	Product description.....	5
2.2	Connections.....	6
2.3	Operation.....	6
2.3.1	Controller settings.....	7
2.4	Dispersion characteristics.....	8
2.5	Technical specifications.....	9
3	Manufacturer's declarations	11
3.1	Conformity of loudspeakers.....	11
3.2	WEEE Declaration (Disposal).....	11

Potential risk of personal injury

Never stand in the immediate vicinity of loudspeakers driven at a high level. Professional loudspeaker systems are capable of causing a sound pressure level detrimental to human health. Seemingly non-critical sound levels (from approx. 95 dB SPL) can cause hearing damage if people are exposed to it over a long period.

In order to prevent accidents when deploying loudspeakers on the ground or when flown, please take note of the following:

- When setting up the loudspeakers or loudspeaker stands, make sure they are standing on a firm surface. If you place several systems on top of one another, use straps to secure them against movement.
- Only use accessories which have been tested and approved by d&b for assembly and mobile deployment. Pay attention to the correct application and maximum load capacity of the accessories as detailed in our specific "Mounting instructions" or in our "Flying system and Rigging manuals".
- Ensure that all additional hardware, fixings and fasteners used for installation or mobile deployment are of an appropriate size and load safety factor. Pay attention to the manufacturers' instructions and to the relevant safety guidelines.
- Regularly check the loudspeaker housings and accessories for visible signs of wear and tear, and replace them when necessary.
- Regularly check all load bearing bolts in the mounting devices.

Potential risk of material damage

Loudspeakers produce a static magnetic field even if they are not connected or are not in use. Therefore make sure when erecting and transporting loudspeakers that they are nowhere near equipment and objects which may be impaired or damaged by an external magnetic field. Generally speaking, a distance of 0.5 m (1.5 ft) from magnetic data carriers (floppy disks, audio and video tapes, bank cards, etc.) is sufficient; a distance of more than 1 m (3 ft) may be necessary with computer and video monitors.

2 T10 loudspeaker

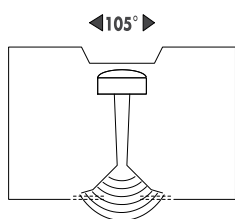
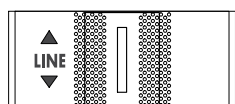
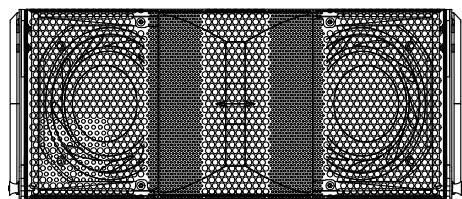

1

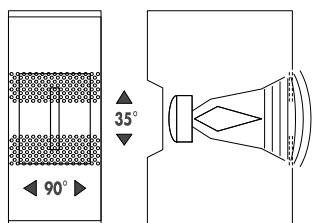

2

T10 Loudspeaker

1: Horn and lens in line source setup

2: Horn and lens in point source setup

2.1 Product description

The T10 is a very compact loudspeaker system which can be used both, as a line array and as a high directivity point source speaker. For these applications, the T10 cabinet provides two different dispersion characteristics which can be swapped over without any tools.

The core of the design is a unique combination of a rotatable waveguide with horn and an acoustic lens. The horn natively provides a vertical line source with 90° horizontal dispersion. The lens is part of the front grill and widens the HF dispersion in line array mode to 105°.

When used upright as a point source, the lens curves the wavefront of the line source providing a 90° x 35° dispersion pattern.

The T10 is a two way design, employing dual 6.5" drivers, a 1.4" exit compression driver and a passive crossover network. The low drivers are positioned in a dipolar arrangement providing an exceptional dispersion control towards low frequencies.

Its frequency response extends from 68 Hz to above 18 kHz.

The cabinet is constructed from polyurethane integral hard foam with an impact and weather resistant black paint finish. The cabinet shape allows the system to be set up as a single unit in upright orientation or as a line array in user defined vertical configurations. The front of the loudspeaker cabinet is protected by a rigid metal grill in front of an acoustically transparent foam.

T-Series rigging components and arrays

For point source applications the T10 is fitted with six threaded inserts to connect to different rigging accessories such as Z5371 T Flying bracket, Z5372 T Horizontal bracket, Z5354 E8/E12 Flying adapter or the Z5020/25 Flying adapter 02/03.

When applied as a line array, cabinets are mechanically connected using the rigging strands on both sides of the cabinet front and a central strand at the rear of the cabinet. All necessary rigging components are mounted to the cabinet and are folded or slide out when needed. Splay angles between adjacent cabinets can be set in the range from 0° to 15°.

A detailed description of the T-Series rigging components is given in the T-Series Rigging manual which is provided with the Z5370 T Flying frame.

T10 line arrays of up to 3 cabinets can be supported with the Z5373 T Cluster bracket which allows an easy aiming of the array either flown or mounted on a high-stand.

A detailed description of planning and designing T arrays is given in the technical information "TI 385 d&b Line array design, d&b ArrayCalc" which is also provided with the T Flying frame.

The d&b ArrayCalc simulation software can be downloaded from the d&b website at www.dbaudio.com.

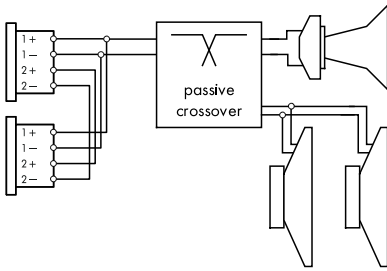

Connector wiring

2.2 Connections

The cabinet is fitted with NLT4 F/M connectors. All four pins of both connectors are wired in parallel. The cabinet uses the pin assignments 1+/1-. Pins 2+/2- are designated to actively driven subwoofers. Using one connector as the input, the second connector allows for direct connection to a second cabinet.

The cabinets can be supplied with NL4 M or EP5 connectors as an option.

Pin equivalents of the connector options are listed in the table below.

NLT4 F/M NL4 M	1+	1-	2+	2-	n.a.
EP5	1	2	3	4	5

d&b LoadMatch

With the d&b four channel amplifier platform, the LoadMatch function enables the amplifier to electrically compensate for the properties of the loudspeaker cable used without the need for an additional sense wire. For applicable loudspeakers, LoadMatch is therefore independent of the connector type used.

2.3 Operation

NOTICE!

Only operate d&b loudspeakers with a correctly configured d&b amplifier, otherwise there is a risk of damaging the loudspeaker components.

Applicable d&b amplifiers:

D80|D40|D12|D20|D6.

Application	Setup	Cabinets per channel
T10 Line source	T10 Arc/T10 Line	4
T10 Point source	T10 PS	4

For applicable d&b amplifiers, the controller setups are available in Dual Channel and/or Mix TOP/SUB mode. For combinations with active subwoofers fed by a single 4-wire cable Mix TOP/SUB mode must be selected.

"T10 Arc" and "T10 Line" setups

These setups are selected when T10 loudspeakers are used as line sources. The selection depends on the curvature of the array. Both setups may be used within one array. The "Arc" setup is used for T10 loudspeakers when used in curved array sections. The "Line" setup is used for long throw array sections with three or more consecutive splay settings of 0°, 1° or 2°. Compared to the "Arc" setup, the upper mid range is reduced to compensate for the

extended near field. The transition from "Line" to "Arc" configuration within the array is made according to the splay progression but may allow for certain deviations due to the wiring of the cabinets in groups of up to four.

"T10 PS" setup

This setup has to be selected when T10 loudspeakers are configured as a point source or when used as single cabinets with horn in line array configuration (e.g. front fill or ceiling mounted).

2.3.1 Controller settings

For acoustic adjustment the functions CUT, HFA, HFC and CPL can be selected.

CUT mode

Set to CUT, the low frequency level is reduced. The T10 is now configured for use with the T-SUB or other d&b active subwoofers.

HFA mode (T10 PS setup only)

In HFA mode (High Frequency Attenuation), the HF response of the system is rolled off. HFA provides a natural, balanced frequency response when a cabinet is placed close to listeners in near field or delay use.

High Frequency Attenuation begins gradually at 1 kHz, dropping by approximately 3 dB at 10 kHz. This roll off mimics the decline in frequency response experienced when listening to a system from a distance in a typically reverberant room or auditorium.

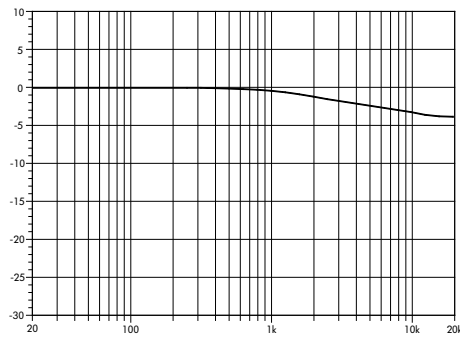

Frequency response correction in HFA mode

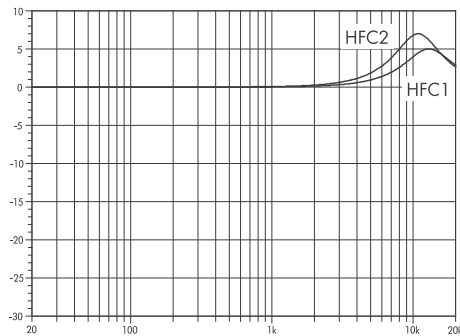

Frequency response correction of the HFC function

HFC function (T10 Arc/Line setups only)

Selecting the HFC (High Frequency Compensation) function compensates for loss of high frequency energy due to absorption in air when loudspeakers are used to cover far field listening positions.

The HFC function has two settings (HFC1, HFC2) for different distances the cabinets need to cover. The settings should be used selectively; HFC1 for cabinets covering distances larger than 25 m (80 ft) and HFC2 for those covering distances larger than 50 m (160 ft).

The compensation is adjusted for a typical relative humidity of 40 %. With lower humidity the absorption by air increases therefore the distances where the respective HFC setting provides a correct equalization are shorter than indicated above.

Using the HFC function provides the correct sound balance between close and remote audience areas, whilst all amplifiers driving the array can be fed with the same signal.

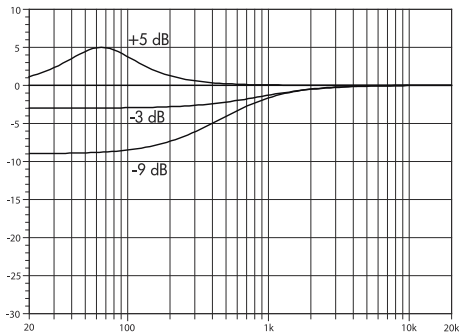

Frequency response correction of the CPL function

CPL function

The CPL (Coupling) function compensates for coupling effects between the cabinets of an array. CPL begins gradually around 1 kHz, with the maximum attenuation below 400 Hz. As coupling effects increase with the length of the line array, the CPL function can be set to dB attenuation values between 0 and -9. With higher attenuation values the corner frequency of the filter shifts towards lower values.

Positive CPL values create an adjustable low frequency boost (0 to +5 dB) and can be set when the system is used in full range mode without subwoofers.

Note: Make sure that all cabinets within the line array are operated with the same CPL setting.

2.4 Dispersion characteristics

The graphs below show dispersion angle over frequency of a single T10 cabinet plotted using lines of equal sound pressure (isobars) at -6 dB and -12 dB.

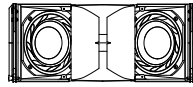
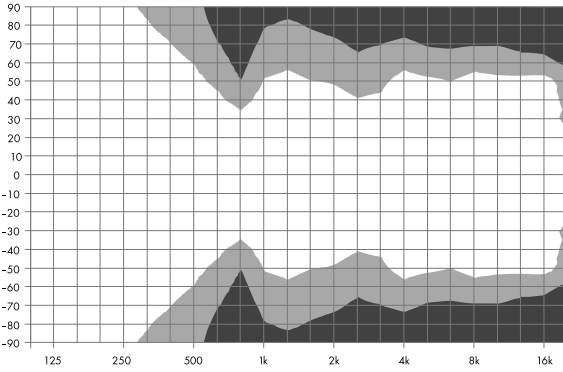

Line source

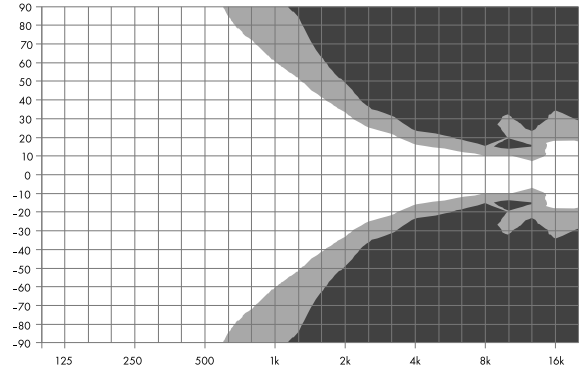

Isobar diagram T10 line source, vertical

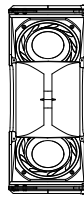
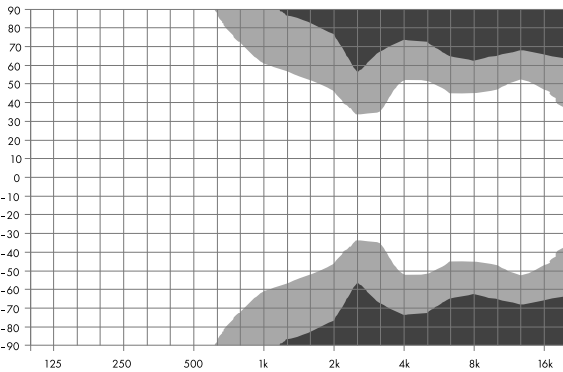

Point source

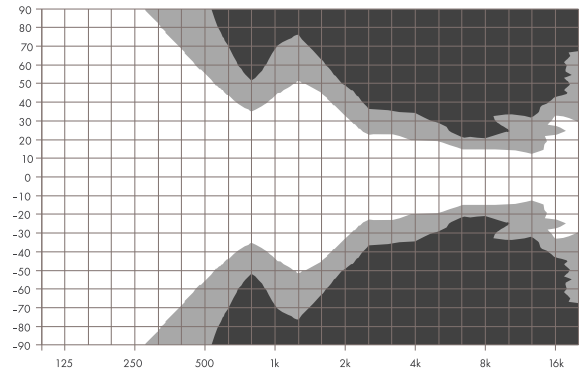

Isobar diagram T10 point source, vertical

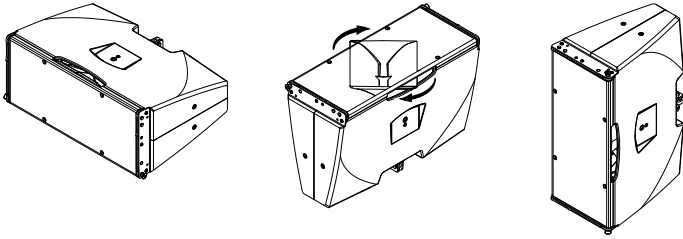

Rotating the horn

Altering the HF dispersion

Swapping between point and line source setups is performed by simply rotating the horn by 90°. The horn is easily accessible from outside of the cabinet and can be rotated without any tools or removal of the front grill.

This is achieved through apertures on the cabinet sides by a mechanism that provides detents at both the line and point source positions.

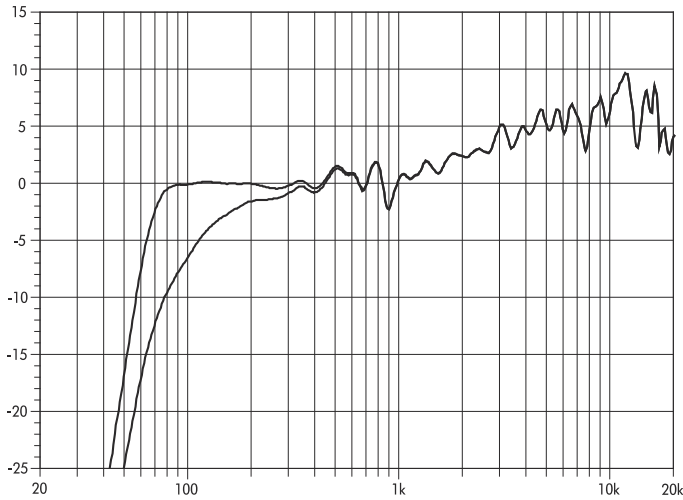

T10 frequency response line source, single cabinet, standard and CUT modes

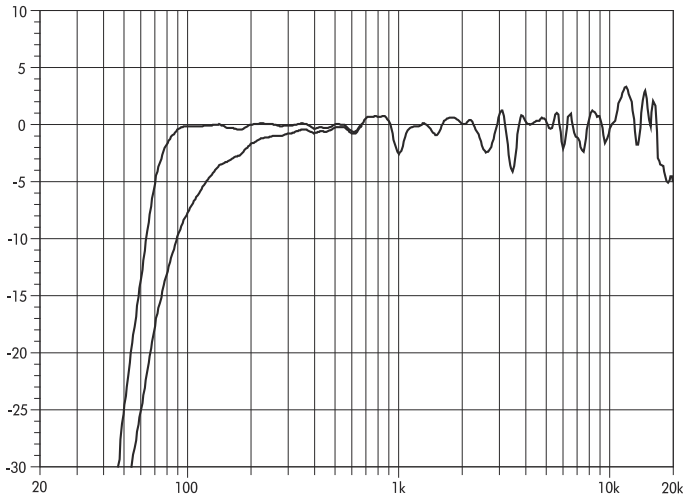

T10 frequency response point source, standard and CUT modes

2.5 Technical specifications

T10 system data

Frequency response (-5 dB standard)	68 Hz - 18 kHz
Frequency response (-5 dB CUT mode)	120 Hz - 18 kHz
Max. sound pressure (Line/Arc setups, 1 m, free field)	
D6	129 dB
D80/D40/D20/D12	132 dB
Max. sound pressure (PS setup, 1 m, free field)	
D6	127 dB
D80/D40/D20/D12	130 dB
..... (SPLmax peak, pink noise test signal with crest factor of 4)	

T10 loudspeaker

Nominal impedance	16 ohms
Power handling capacity (RMS/peak 10 ms)	200/800 W
Nominal dispersion angle (line source, horizontal)	105°
Splay angle settings	0 ... 15° (1° increment)
Nominal dispersion angle (point source, h x v)	90° x 35°
Components	2 x 6.5" driver with neodymium magnet
.....	1.4" exit compression driver on rotatable waveguide
.....	Passive crossover network
Connections	2 x NLT4 F/M
.....	optional EP5
Pin assignment	NLT4 F/M: 1+/1-
.....	EP5: 1: + / 2: -
Weight	11 kg (24 lb)

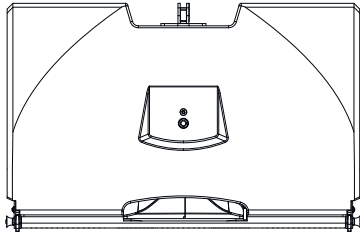
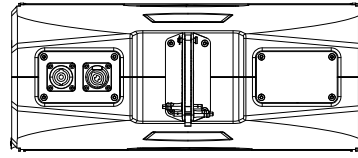
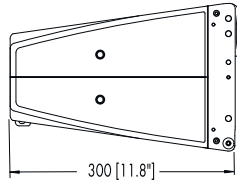
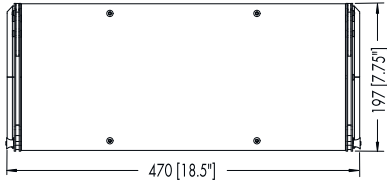

T10 cabinet dimensions in mm [inch]



3.1 Conformity of loudspeakers

This declaration applies to:

d&b Z0550 T10 loudspeaker

by d&b audiotechnik GmbH & Co. KG.

All product variants are included, provided they correspond to the original technical version and have not been subject to any later design or electromechanical modifications.

We herewith declare that said products are in conformity with the provisions of the respective directives including all applicable amendments.

Detailed and applicable declarations are available on request and can be ordered from d&b or downloaded from the d&b website at www.dbaudio.com.

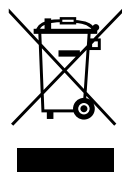

3.2 WEEE Declaration (Disposal)

Electrical and electronic equipment must be disposed of separately from normal waste at the end of its operational lifetime.

Please dispose of this product according to the respective national regulations or contractual agreements. If there are any further questions concerning the disposal of this product, please contact d&b audiotechnik.

WEEE-Reg.-Nr. DE: 13421928

